

Input voltage up to 60 VDC
Single output of 3.3 - 24 VDC
No input to output isolation

- High efficiency up to 93%
- Wide input voltage range
- Low input to output differential voltage
- Very good dynamic properties
- Input undervoltage lock-out
- Parallel configurations possible
- Continuous no-load and short-circuit proof
- No derating

Safety according to IEC/EN 60950



Summary

The PSC series of positive switching regulators is designed as power supply modules for electronic systems. Their major advantages include a high level of efficiency that remains virtually constant over the entire input range, high reliability, low ripple and excellent dynamic response. Mod-

ules with input voltages up to 60 V are specially designed for secondary switched and battery driven applications. The case design allows operation at nominal load up to 50°C without additional cooling.

Model Selection and Key Data

Table 1: Type survey

Output voltage $V_{O\text{ nom}}$ [V]	Output current $I_{O\text{ nom}}$ [A]	Input voltage range V_i [V] ¹	Input voltage $V_{i\text{ nom}}$ [V]	Efficiency ² η_{min} [%]	Type designation	Options package
3.3	12	7 - 40	20	77	PSC 3E12-2	iR package
5.1	11	8 - 40	20	78	PSC 5A11-2	
12	9	15 - 40	20	89	PSC 129-2	
15	9	19 - 40	30	90	PSC 159-2	
24	9	29 - 60	40	93	PSC 249-2	

¹ See also: *Electrical Input Data*: $\Delta V_{i0\text{ min}}$. (min. difference $V_i - V_o$)

² Efficiency at $V_{i\text{ nom}}$ and $I_{O\text{ nom}}$.

Table of Contents

	Page		Page
Summary	1	Electromagnetic Compatibility (EMC)	5
Model Selection and Key Data	1	Immunity to Environmental Conditions	6
Type Key	2	Mechanical Data	6
Functional Description	2	Safety and Installation Instructions	8
Electrical Input Data	3	Description of Options	9
Electrical Output Data	4	EC-Declaration of Conformity	12

Part Number Description

Positive switching regulator in case C03	PSC	_____	PSC 12 9 -2 iR
Nominal output voltage in volt (3E for 3.3V, 5A for 5.1V)3E, ...24	_____	_____	_____
Nominal output current in ampere	9 - 12	_____	_____
Operational ambient temperature range T_A -10 to 50°C	-2	_____	_____
Option package:			
Inhibit input	i	_____	_____
Control input for output voltage adjustment	R	_____	_____

Example: PSC 129-2iR = A positive switching regulator with a 12 V, 9 A output, ambient temperature range of -10 to 50°C, with options package inhibit and output voltage adjustment.

Functional Description

The switching regulators are designed using the buck converter topology. See also: *Technical Information: Topologies*. The input is not electrically isolated from the output. During the on period of the switching transistor, current is transferred to the output and energy is stored in the output choke. During the off period, this energy forces the current to continue flowing through the output, to the load and back through the freewheeling diode. Regulation is accomplished by varying the on to off duty ratio of the power switch.

These regulators are ideal for a wide range of applications, where input to output isolation is not necessary, or where already provided by an external front end (e.g. a transformer with rectifier). To optimise customer's needs, additional options and accessories are available.

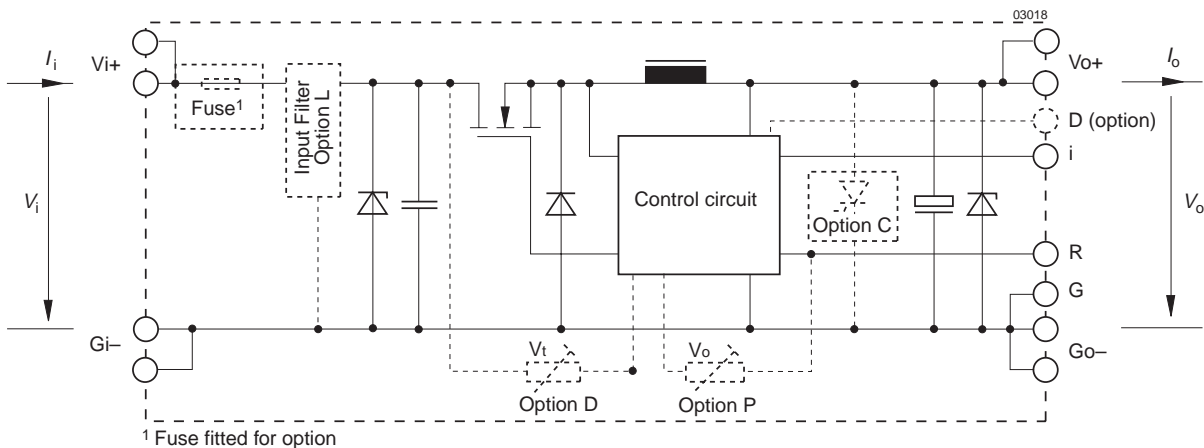

Fig. 1
Block diagram

Electrical Input Data

General Conditions: $T_A = 25^\circ\text{C}$, unless T_C is specified

Table 2a: Input data

Input			PSC 3E12			PSC 5A11			PSC 129			Unit
Characteristics		Conditions	min	typ	max	min	typ	max	min	typ	max	
V_i	Operating input voltage	$I_o = 0 - I_{o\text{ nom}}$	7		40	8		40	15		40	VDC
$\Delta V_{i0\text{ min}}$	Min. diff. voltage $V_i - V_o$	$T_C\text{ min} - T_C\text{ max}$			2.7			2.9			3	
V_{i0}	Undervoltage lock-out			4.7			7.3			7.3		
I_{i0}	No load input current	$I_o = 0, V_{i\text{ min}} - V_{i\text{ max}}$			50			50			50	mA
$I_{\text{inr p}}$	Peak value of inrush current	$V_{i\text{ nom}}$		150			150			150		A
$t_{\text{inr r}}$	Rise time			5			5			5		μs
$t_{\text{inr h}}$	Time to half-value			40			40			40		
$U_{\text{i RFI}}$	Input RFI level, EN 55011/22 0.15 - 30 MHz ¹	$V_{i\text{ nom}}, I_{o\text{ nom}}$			A			A			A	

Table 2b: Input data

Input			PSC 159			PSC 249			Unit
Characteristics		Conditions	min	typ	max	min	typ	max	
V_i	Operating input voltage	$I_o = 0 - I_{o\text{ nom}}$	19		40	29		60	VDC
$\Delta V_{i0\text{ min}}$	Min. diff. voltage $V_i - V_o$	$T_C\text{ min} - T_C\text{ max}$			4			5	
V_{i0}	Undervoltage lock-out			7.3			12		
I_{i0}	No load input current	$I_o = 0, V_{i\text{ min}} - V_{i\text{ max}}$			50			50	mA
$I_{\text{inr p}}$	Peak value of inrush current	$V_{i\text{ nom}}$		250			250		A
$t_{\text{inr r}}$	Rise time			5			5		μs
$t_{\text{inr h}}$	Time to half-value			40			40		
$U_{\text{i RFI}}$	Input RFI level, EN 55011/22 0.15 - 30 MHz ¹	$V_{i\text{ nom}}, I_{o\text{ nom}}$			A			A	

¹ Additional external input filter or capacitor necessary.

External Input Circuitry

The sum of the lengths of the supply lines to the source or to the nearest capacitor $\geq 100\ \mu\text{F}$ (a + b) should not exceed 5 m unless an external input filter with capacitor is fitted. This filter is recommended in order to prevent power line oscillations and reduce superimposed interference voltages. See also: *Technical Information: Application Notes*.

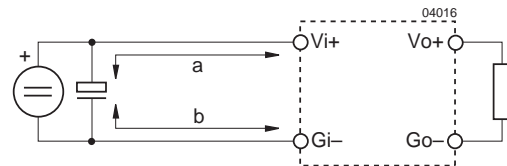

Fig. 2
Switching regulator with long supply lines.

Electrical Output Data

General Conditions:

– $T_A = 25^\circ\text{C}$, unless T_C is specified

– With R or option P, output voltage $V_o = V_{o\text{nom}}$ at $I_{o\text{nom}}$

Table 3a: Output data

Output			PSC 3E12			PSC 5A11			PSC 129			Unit	
Characteristics		Conditions	min	typ	max	min	typ	max	min	typ	max		
V_o	Output voltage	$V_{i\text{nom}}, I_{o\text{nom}}$	3.25	3.35		5.05	5.15		11.60	12.40		V	
I_o	Output current ¹	$V_{i\text{min}} - V_{i\text{max}}$	0	12.0		0	11.0		0	9.0		A	
I_{oL}	Output current limitation response ¹	$T_{C\text{min}} - T_{C\text{max}}$	12.0	15.6		11.0	14.3		9.0	11.7			
u_o	Output voltage noise	Switching freq.	$V_{i\text{nom}}, I_{o\text{nom}}$			55			55			150	mV _{pp}
		Total	IEC/EN 61204 ² BW = 20 MHz			60			60			160	
ΔV_{oU}	Static line regulation	$V_{i\text{min}} - V_{i\text{max}}, I_{o\text{nom}}$	100			100			240			mV	
ΔV_{oI}	Static load regulation	$V_{i\text{nom}}, I_o = 0 - I_{o\text{nom}}$	100			100			120				
u_{od}	Dynamic load regulation	Voltage deviat.	$V_{i\text{nom}}$			150			130			360	μs
t_d		Recovery time	$I_{o\text{nom}} \leftrightarrow \frac{1}{3} I_{o\text{nom}}$ IEC/EN 61204 ²			50			50			60	
α_{Uo}	Temperature coefficient $\Delta V_o / \Delta T_C (T_{C\text{min}} - T_{C\text{max}})$	$V_{i\text{min}} - V_{i\text{max}}$ $I_o = 0 - I_{o\text{nom}}$	± 1			± 1			± 2			mV/K	
			± 0.02			± 0.02			± 0.02			%/K	

Table 3b: Output data

Output			PSC 159			PSC 249			Unit			
Characteristics		Conditions	min	typ	max	min	typ	max				
V_o	Output voltage	$V_{i\text{nom}}, I_{o\text{nom}}$	14.50	15.50		23.30	24.70		V			
I_o	Output current ¹	$V_{i\text{min}} - V_{i\text{max}}$	0	9.0		0	9.0		A			
I_{oL}	Output current limitation response	$T_{C\text{min}} - T_{C\text{max}}$	9.0	11.7		9.0	11.7					
u_o	Output voltage noise	Switching freq.	$V_{i\text{nom}}, I_{o\text{nom}}$			200			300			mV _{pp}
		Total	IEC/EN 61204 ² BW = 20 MHz			210			310			
ΔV_{oU}	Static line regulation	$V_{i\text{min}} - V_{i\text{max}}, I_{o\text{nom}}$	300			480			mV			
ΔV_{oI}	Static load regulation	$V_{i\text{nom}}, I_o = 0 - I_{o\text{nom}}$	150			240						
u_{od}	Dynamic load regulation	Voltage deviat.	$V_{i\text{nom}}$			450			700			μs
t_d		Recovery time	$I_{o\text{nom}} \leftrightarrow \frac{1}{3} I_{o\text{nom}}$ IEC/EN 61204 ²			60			80			
α_{Uo}	Temperature coefficient $\Delta V_o / \Delta T_C (T_{C\text{min}} - T_{C\text{max}})$	$V_{i\text{min}} - V_{i\text{max}}$ $I_o = 0 - I_{o\text{nom}}$	± 3			± 5			mV/K			
			± 0.02			± 0.02			± 0.02			%/K

¹ See also: *Thermal Considerations*.

² See: *Technical Information: Measuring and Testing*.

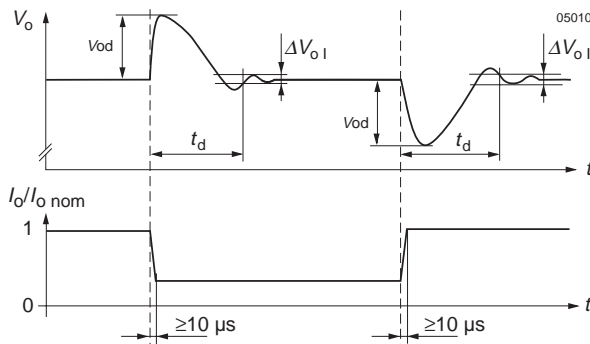

Fig. 3
Dynamic load regulation.

Thermal Considerations

When a switching regulator is located in free, quasi-stationary air (convection cooling) at a temperature $T_A = 50^\circ\text{C}$ and is operated at its nominal output current $I_o \text{ nom}$, the case temperature T_C will be about 80°C after the warm-up phase, measured at the *Measuring point of case temperature* T_C (see: *Mechanical Data*).

Under practical operating conditions, the ambient temperature T_A may exceed 50°C , provided additional measures (heat sink, fan, etc.) are taken to ensure that the case temperature T_C does not exceed its maximum value of 80°C .

Example: Sufficient forced cooling allows $T_{A \text{ max}} = 65^\circ\text{C}$. A simple check of the case temperature T_C ($T_C \leq 80^\circ\text{C}$) at full load ensures correct operation of the system.

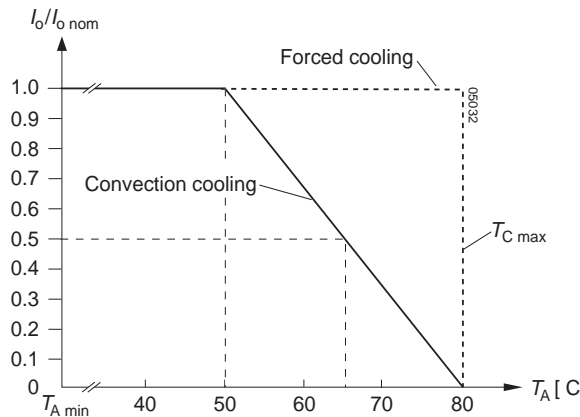

Fig. 4
Output current derating versus temperature.

Parallel and Series Connection

Outputs of equal nominal voltages can be parallel-connected. However, the use of a single unit with higher output power, because of its power dissipation, is always a better solution.

In parallel-connected operation, one or several outputs may operate continuously at their current limit knee-point which will cause an increase of the heat generation. Consequently, the max. ambient temperature value should be reduced by 10 K.

Outputs can be series-connected with any other module. In series-connection the maximum output current is limited by the lowest current limitation. Electrically separated source voltages are needed for each module!

Output Protection

A voltage suppressor diode which in worst case conditions fails into a short circuit, protects the output against an internally generated overvoltage. Such an overvoltage could occur due to a failure of either the control circuit or the switching transistor. The output protection is not designed to withstand externally applied overvoltages. The user should ensure that systems with Power-One power supplies, in the event of a failure, do not result in an unsafe condition (fail-safe).

Short Circuit Behaviour

A constant current limitation circuit holds the output current almost constant whenever an overload or a short circuit is applied to the regulator's output. It acts self-protecting and recovers – in contrary to the fold back method – automatically after removal of the overload or short circuit condition.

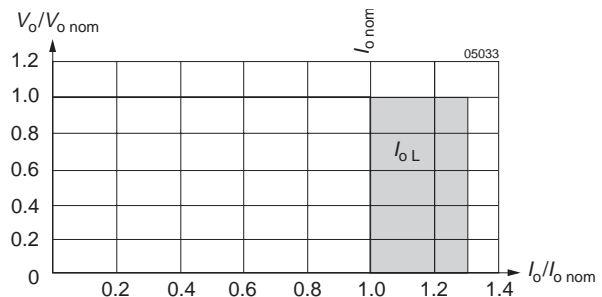

Fig. 5
Overload, short-circuit behaviour V_o versus I_o .

Electromagnetic Compatibility (EMC)

Electromagnetic Immunity

General condition: Case not earthed.

Table 4: Immunity type tests

Phenomenon	Standard ¹	Class Level	Coupling mode ²	Value applied	Waveform	Source Imped.	Test procedure	In oper.	Per-form. ³
Electrostatic discharge	IEC/EN 61000-4-2	2	contact discharge to case	4000 V _p	1/50 ns	330 Ω	10 positive and 10 negative discharges	yes	A ⁴
Electromagnetic field	IEC/EN 61000-4-3	2	antenna	3 V/m	AM 80% 1 kHz		80 - 1000 MHz	yes	A
Electrical fast transients/burst	IEC/EN 61000-4-4	2	i/c, +i/-i	1000 V _p	bursts of 5/50 ns 5 kHz rep. rate transients with 15 ms burst duration and a 300 ms period	50 Ω	60 s positive 60 s negative bursts per coupling mode	yes	A ⁴
		3		2000 V _p					B ⁴
Surge	IEC/EN 61000-4-5	2	i/c	1000 V _p	1.2/50 μs	12 Ω	5 pos. and 5 neg. surges per coupling mode	yes	A ⁴
			+i/-i	500 V _p					
Conducted disturbances	IEC/EN 61000-4-6	2	i, o, signal wires	130 dBμV (3 VAC)	AM 80% 1 kHz	150 Ω	0.15 - 80 MHz	yes	A

¹ For related and previous standards see: *Technical Information: Safety & EMC*. ² i = input, o = output, c = case.

³ A = Normal operation, no deviation from specifications, B = Normal operation, temporary deviation from specs possible.

⁴ External input filter necessary.

For emission levels refer to: *Electrical Input Data*.

Immunity to Environmental Conditions

Table 5: Mechanical stress

Test Method	Standard	Test Conditions	Status
Ca Damp heat steady state	IEC/DIN 60068-2-3 MIL-STD-810D section 507.2	Temperature: 40 ±2 °C Relative humidity: 93 +2/-3 % Duration: 21 days	Unit not operating
Ea Shock (half-sinusoidal)	IEC/EN/DIN 60068-2-27 MIL-STD-810D section 516.3	Acceleration amplitude: 15 g _n = 147 m/s ² Bump duration: 11 ms Number of bumps: 18 (3 each direction)	Unit operating
Eb Bump (half-sinusoidal)	IEC/EN/DIN 60068-2-29 MIL-STD-810D section 516.3	Acceleration amplitude: 10 g _n = 392 m/s ² Bump duration: 16 ms Number of bumps: 6000 (1000 each direction)	Unit operating
Fc Vibration (sinusoidal)	IEC/EN/DIN 60068-2-6 MIL-STD-810D section 514.3	Acceleration amplitude: 0.15 mm (10 - 60 Hz) 2 g _n = 20 m/s ² (60 - 150 Hz) Frequency (1 Oct/min): 10 - 150 Hz Test duration: 3.75 h (1.25 h each axis)	Unit operating

Table 6: Temperature specifications, valid for air pressure of 800 - 1200 hPa (800 - 1200 mbar)

Temperature		Standard		Unit
Characteristics	Conditions	min	max	
T _A Ambient temperature	Operational ¹	-10	50	°C
T _C Case temperature		-10	80	
T _S Storage temperature	Non operational	-25	100	

¹ See *Thermal Considerations*

Table 7: MTBF

MTBF	Ground Benign
MTBF acc. to MIL-HDBK-217F	$T_C = 40^\circ\text{C}$
	484'000 h

Mechanical Data

Dimensions in mm. Tolerances ± 0.3 mm unless otherwise specified.



09019

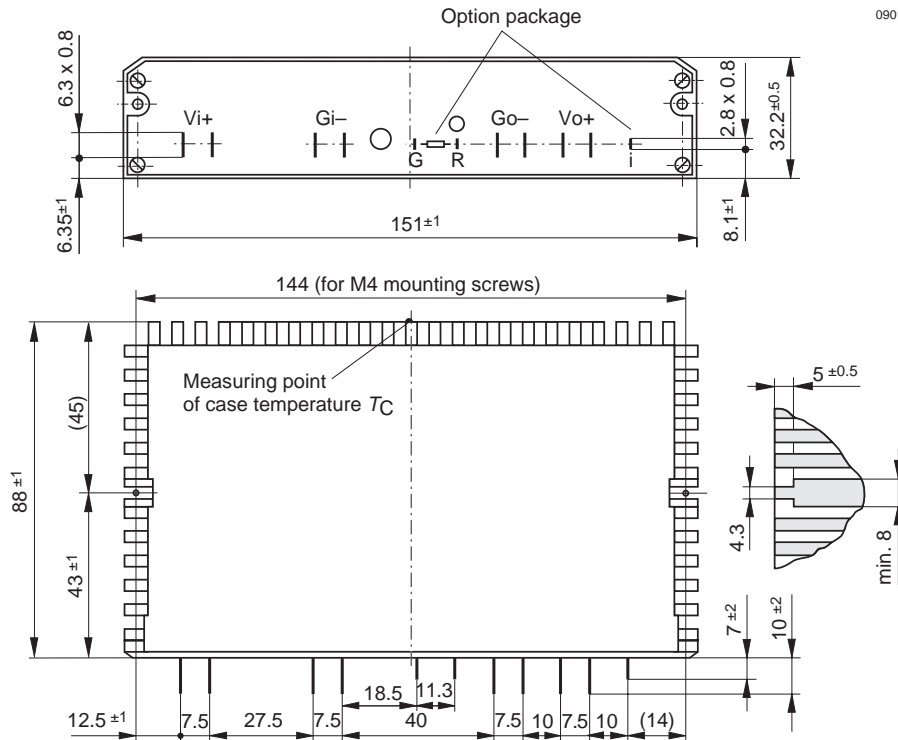

Fig. 6
Case C03, weight 440 g
Aluminium,
black finish and self cooling

Safety and Installation Instructions

Installation Instruction

Installation of the switching regulators must strictly follow the national safety regulations in compliance with the enclosure, mounting, creepage, clearance, casualty, markings and segregation requirements of the end-use application.

Check for hazardous voltages before altering any connections. Connections can be made using fast-on or soldering technique.

The input and the output circuit are not separated, i.e. the negative path is internally interconnected!

The units should be connected to a secondary circuit.

Do not open the module.

Ensure that a unit failure (e.g. by an internal short-circuit) does not result in a hazardous condition. See also: *Safety of operator accessible output circuit*.

Cleaning Agents

In order to avoid possible damage, any penetration of cleaning fluids is to be prevented, since the power supplies are not hermetically sealed.

Protection Degree

The protection degree is IP 20.

Standards and Approvals

All switching regulators are UL recognized according to UL 1950, UL 1012 and EN 60950, UL recognized for Canada to CAN/CSA C22.2 No. 234-M90.

The units have been evaluated for:

- Building in,
- Operational insulation from input to output and input/output to case,
- The use in an overvoltage category II environment,
- The use in a pollution degree 2 environment.

The switching regulators are subject to manufacturing surveillance in accordance with the above mentioned UL and CSA and with ISO 9001 standards.

Isolation

Electric strength test voltage between input interconnected with output against case: 500 VDC, 1 s.

This test is performed in the factory as routine test in accordance with EN50116, IEC/EN 60950 and UL 1950 and should not be repeated in the field. Power-One will not honour any guarantee claims resulting from electric strength field tests.

Safety of Operator Accessible Output Circuit

If the output circuit of a switching regulator is operator-accessible, it shall be an SELV circuit according to IEC/EN 60950 related safety standards

The following table shows some possible installation configurations, compliance with which causes the output circuit of the switching regulator to be an SELV circuit according to IEC/EN 60950 up to a nominal output voltage of 30 V.

However, it is the sole responsibility of the installer or user to assure the compliance with the relevant and applicable safety regulations.

More information is given in: *Technical Information: Safety & EMC*.

Table 8: Insulation concept leading to an SELV output circuit

Conditions	Front end			Switching regulator	Result
Supply voltage	Minimum required grade of isolation, to be provided by the AC-DC front end, including mains supplied battery charger	Maximum DC output voltage from the front end ¹	Minimum required safety status of the front end output circuit	Measures to achieve the specified safety status of the output circuit	Safety status of the switching regulator output circuit
Battery supply, considered as secondary circuit	Double or Reinforced	≤60 V	SELV circuit	None	SELV circuit
Mains ≤250 V AC	Basic	≤60 V	Earthed SELV circuit ²	None	Earthed SELV circuit
			ELV circuit	Input fuse ³ and earthed output circuit ² or non accessible case ⁴	
	Double or reinforced	≤60 V	SELV circuit	None	SELV circuit

¹ The front end output voltage should match the specified input voltage range of the switching regulator.

² The earth connection has to be provided by the installer according to the relevant safety standard, e.g. IEC/EN 60950.

³ The installer shall provide an approved fuse (slow blow type with the lowest current rating suitable for the application, max.12.5 A) in a non-earthed input conductor directly at the input of the switching regulator. If Vo+ is earthed, insert the fuse in the Gi- line. For UL's purpose, the fuse needs to be UL-listed. If option C is fitted, a suitable fuse is already built-in in the Vi+ line.

⁴ Has to be insulated from earth by double or reinforced insulation according to the relevant safety standard, based on the maximum output voltage from the front end.

Description of Options

With this series, the options i (inhibit) and R (control input for output voltage adjustment) are defined as a package. Other combinations or parts of this package are not available.

R Control for Output Voltage Adjustment

Note: With open R input, $V_o \approx V_{o\ nom}$.

The output voltage V_o can either be adjusted with an external reference voltage (V_{ext}) or with an external resistor (R_{ext}). The adjustment range is 0 - 100% of $V_{o\ nom}$. The

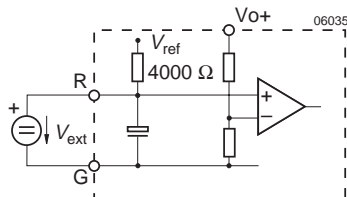

Fig. 7
Voltage adjustment with V_{ext} between R and G (Go-)

$$V_{ext} \approx 2.5 \text{ V} \cdot \frac{V_o}{V_{o\ nom}} \quad V_o \approx V_{o\ nom} \cdot \frac{V_{ext}}{2.5 \text{ V}}$$

Caution: To prevent damage V_{ext} must neither exceed 2.7 V, nor be negative!

minimum differential voltage $\Delta V_{io\ min}$ between input and output (see: *Electrical Input Data*) should be maintained. Undervoltage look-out = minimum input voltage.

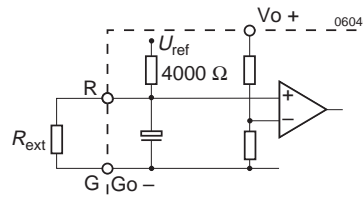

Fig. 8
Voltage adjustment with external resistor R_{ext}

$$R_{ext} \approx \frac{4000 \Omega \cdot V_o}{V_{o\ nom} - V_o} \quad V_o \approx \frac{V_{o\ nom} \cdot R_{ext}}{R_{ext} + 4000 \Omega}$$

i Inhibit for Remote On/Off

Note: With open i-input, output is enabled ($V_o = \text{on}$)

The inhibit input allows the switching regulator output to be disabled via a control signal. In systems with several units, this feature can be used, for example, to control the activation sequence of the regulators by a logic signal (TTL, CMOS, etc.). An output voltage overshoot will not occur when switching on or off.

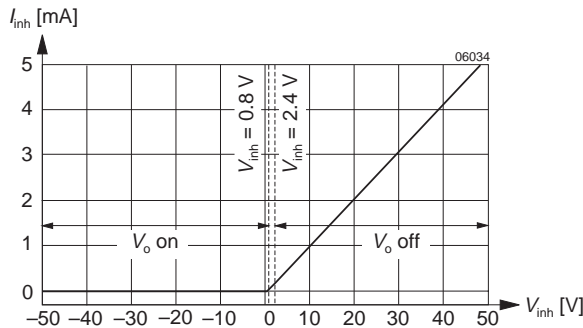

Fig. 9
Typical inhibit current I_{inh} versus inhibit voltage V_{inh}

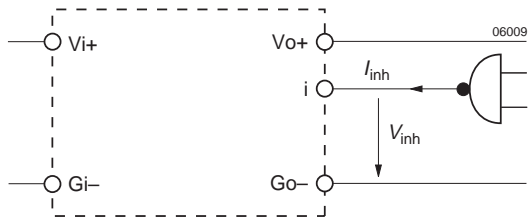

Fig. 10
Definition of I_{inh} and V_{inh}

Table 9: Inhibit characteristics

Characteristics		Conditions	min	typ	max	Unit
V_{inh}	Inhibit input voltage to keep regulator output voltage -	$V_o = \text{on}$	-50		+0.8	VDC
		$V_o = \text{off}$	+2.4		+50	
t_r	Switch-on time after inhibit command	$V_i = V_{i \text{ nom}}$		5		ms
t_f	Switch-off time after inhibit command	$R_L = V_o \text{ nom} / I_o \text{ nom}$		10		
$I_{i \text{ inh}}$	Input current when inhibited	$V_i = V_{i \text{ nom}}$		10		mA

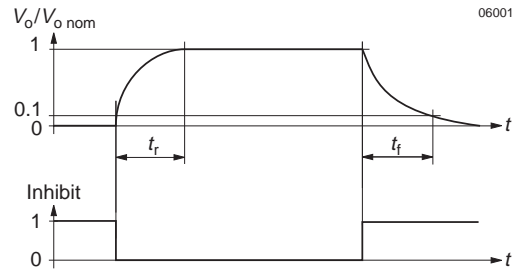

Fig. 11
Output response as a function of inhibit signal

Accessories

A variety of electrical and mechanical accessories are available including:

- PCB-tags and isolation pads for easy and safe PCB-mounting.
- Ring core chokes for ripple and interference reduction.

For more detailed information please refer to: *Accessories* on the Power-One homepage.



NUCLEAR AND MEDICAL APPLICATIONS - Power-One products are not authorized for use as critical components in life support systems, equipment used in hazardous environments, or nuclear control systems without the express written consent of the respective divisional president of Power-One, Inc.

TECHNICAL REVISIONS - The appearance of products, including safety agency certifications pictured on labels, may change depending on the date manufactured. Specifications are subject to change without notice.

EC Declaration of Conformity

We

Power-One AG
Ackerstrasse 56 CH-8610 Uster

declare under our sole responsibility that all PSx Series switching regulators carrying the CE-mark are in conformity with the provisions of the Low Voltage Directive (LVD) 73/23/EEC of the European Communities.

Conformity with the directive is presumed by conformity with the following harmonized standards:

- EN 61204: 1995 (= IEC 61204: 1993, modified)
Low-voltage power supply devices, d.c. output - Performance characteristics and safety requirements
 - EN 60950: 1992 + A1: 1993 + A2 (= IEC 950 second edition 1991 + A1: 1992 + A2: 1993)
Safety of information technology equipment
-

The installation instructions given in the corresponding data sheet describe correct installation leading to the presumption of conformity of the end product with the LVD. All PSx Series Switching Regulators are components, intended exclusively for inclusion within other equipment by an industrial assembly operation or by professional installers. They must not be operated as stand alone products.

Hence conformity with the Electromagnetic Compatibility Directive 89/336/EEC (EMC Directive) needs not to be declared. Nevertheless, guidance is provided in most product application notes on how conformity of the end product with the indicated EMC standards under the responsibility of the installer can be achieved, from which conformity with the EMC directive can be presumed.

Uster, 14 Oct. 2003

Power-One AG



Rolf Baldauf
Director Engineering



Johann Milavec
Director Projects and IP