



*Best USB Audio Single Chip for PC Speakers Solution*

---

# **CM102-A+/102S+** **USB 2CH Audio Controller for Speaker**

## **Datasheet** **Version 1.01**

**C-MEDIA ELECTRONICS INC.**

**TEL: 886-2-8773-1100 FAX: 886-2-8773-2211**

**6F, 100, Sec. 4, Civil Boulevard, Taipei, Taiwan 106, R.O.C.**

For detailed product information, please contact [sales@cmedia.com.tw](mailto:sales@cmedia.com.tw)

www.DataSheet4U.com



## NOTICES

THIS DOCUMENT IS PROVIDED "AS IS" WITH NO WARRANTIES WHATSOEVER, INCLUDING ANY WARRANTY OF MERCHANTABILITY, NONINFRINGEMENT, FITNESS FOR ANY PARTICULAR PURPOSE, OR ANY WARRANTY OTHERWISE ARISING OUT OF ANY PROPOSAL, DOCUMENT OR SAMPLE.

ALL RIGHTS RESERVED. NO PART OF THIS DOCUMENT MAY BE REPRODUCED OR TRANSMITTED IN ANY FORM OR BY ANY MEANS, ELECTRONIC OR MECHANICAL, INCLUDING INFORMATION STORAGE AND RETRIEVAL SYSTEMS, WITHOUT PERMISSION IN WRITING FROM C-MEDIA ELECTRONICS, INC.

### COPYRIGHT

**Copyright (c) 2005-2007 C-Media Electronics Inc.**

All rights reserved. All content included on this document, such as text, graphics, logos, button icons, images, audio clips, digital downloads, data compilations, and software, is either the exclusive property of C-Media Electronics Inc., its affiliates (collectively, "C-Media"), its content suppliers, or its licensors and protected by Republic of China and international copyright laws.

### TRADEMARKS

C-Media, the C-Media Logo, Xear 3D, Xear 3D Logo, Speaker Shifter, Smart Jack, and Smart Audio Jack are trademarks of C-Media Electronics Inc. in Republic of China and/or other countries. All other brand and product names listed are trademarks or registered trademarks of their respective holders and are hereby recognized as such.

***\*C-Media reserves the right to modify the specifications without further notice\****



## TABLE OF CONTENTS

<b>1. DESCRIPTIONS AND OVERVIEW</b>	<b>5</b>
<b>2. FEATURES</b>	<b>6</b>
<b>3. PIN/SIGNAL DESCRIPTIONS</b>	<b>7</b>
3.1 PIN ASSIGNMENT BY PIN NUMBER	7
3.2 PIN-OUT DIAGRAM	7
3.3 PIN SIGNAL DESCRIPTIONS	8
<b>4. BLOCK DIAGRAM</b>	<b>10</b>
<b>5. ORDERING INFORMATION</b>	<b>11</b>
<b>6. FUNCTION DESCRIPTIONS</b>	<b>12</b>
6.1 USB INTERFACE	12
6.1.1 DEVICE DESCRIPTOR	12
6.1.2 CONFIGURATION DESCRIPTOR	13
6.1.3 USB AUDIO TOPOLOGY DIAGRAM	13
6.2 DYNAMIC RANGE CONTROL (DRC)	14
<b>7. ELECTRICAL CHARACTERISTICS</b>	<b>15</b>
7.1 ABSOLUTE MAXIMUM RATING	15
7.2 OPERATION CONDITIONS	15
7.3 SPERKER IMPEDANCE V.S. OUTPUT POWER (PER CHANNEL)	16
7.4 AUDIO PERFORMANCE	16
<b>8. AUDIO PERFORMANCE CURVES</b>	<b>18</b>
8.1 FREQUENCY RESPONSE (10K OHM LOADING)	18
8.1.1 FREQUENCY RESPONSE @ 44.1 KS/SEC	18



8.1.2	FREQUENCY RESPONSE @ 48 KS/SEC	18
8.2	PASSBAND RIPPLE (10K OHM LOADING)	19
8.2.1	PASSBAND RIPPLE @ 44.1 KS/SEC	19
8.2.2	PASSBAND RIPPLE @ 48 KS/SEC	19
9.	REFERENCE APPLICATION CIRCUIT	20
10.	REFERENCE	20



## 1. DESCRIPTIONS AND OVERVIEW

CM102-A+/102S+ series is a highly integrated single chip for USB stereo speakers application. Minimum external components are needed for building an USB speaker system, which makes CM102-A+/102S+ a simple and very cost-effective solution. Since no driver is necessary for audio playback on all major OS. CM102-A+/102S+ provides a truly plug-and-play feature for external digital audio playback.

For energy saving, USB suspend mode and resume is supported by CM102-A+/102S+. With power amplifier enable pin and volume control VR input pin, a traditional speaker front panel design can be built. This new single chip not only support 44.1KHz and 48KHz sampling rate playback but also with X2 modulation for hi-frequency quality. Better yet, simplify anti-pop noise solution was embedded on chip for general pop noise issues. All of the functions have been approved by USB IF certification program. More flexible and customized design is possible with GPIO pin, which is accessible by USB vendor specific request.

This one chip solution not only embedded USB transceiver, ADC, DAC component but also integrated digital control power amplifier function for USB digital sound application. The Dynamic Range Control function can support high efficiency volume output to get loudness sound effect similar D class amplifier capability. Vender can just using single chip to saving external amplifier component and getting a better listen experience when listen to a music source with wide dynamic range.

Moreover, customers can use C-Media USB Audio Driver with Xear 3D functions to show up digital speaker features and upgrade PC multi-media stereo function to be a CE like devices. Xear 3D can support 10 band Equalizer, EnvironmentFX sound effects and virtual 7.1CH speaker shifter. This driver is optional for free bundle.

### **Best USB Audio Chip for Digital Stereo Speakers Solution**

## 2. FEATURES

- USB 2.0 Full Speed Compatible and USB IF Certification
- USB audio device class specification v1.0 Compatible
- USB bus powered 500mA operation with suspend mode support
- USB audio function topology has 1 input terminal, 1 output terminal, and 1 feature unit
- Embedded high performance 16 bit stereo audio DAC
- Embedded Digital Control Power Amplifier for Speaker Driving
- Embedded power on reset block and Power amplifier enable / disable control pin
- Embedded X2 Modulation for Higher Audio Quality
- Embedded Anti-Pop Circuit with Internal Feedback Structure
- Embedded 5V to 3.3V Regulator with Voltage Level Detector for Single 5V External Power Supply
- Alternate zero bandwidth setting for releasing bandwidth on USB bus during inactive operation
- Single 12MHz crystal input with on-chip PLL and embedded USB transceiver
- Support Dynamic Range Control (DRC) Feature to Provide a Better Listen Experience
- Volume control input with simple external VR circuit
- Isochronous transfer using adaptive synchronization with internal PLL
- High performance 16-Bit Stereo, 48 / 44.1 KHz Sampling Rate for Audio Playback
- 3.3V IO with 5V tolerance; 3.3V core logics design
- GPIO pin for application specific usage
- Support S/PDIF output interface
- LED Indicator Pin During Playback
- Compatible with Win 98SE / Win ME / Win 2000 / Win XP, and Mac OS 9 / OS X without additional driver
- USB Software Drive Xear 3D Sound Technology With HRTF 3D, EAX™, Speaker Shifter and Virtual 7.1CH effects for free bundle
- Compact 18 pin PDIP and SOP package

### 3. PIN/SIGNAL DESCRIPTIONS

#### 3.1 PIN ASSIGNMENT BY PIN NUMBER

Pin #	Signal Name	Pin #	Signal Name
1	PAEN	10	TEST
2	GPIO	11	VREF
3	XO	12	VOLADJ
4	XI	13	AVDD
5	DVDD5V	14	LOL
6	REGV	15	LOR
7	USBDP	16	AVSS
8	USBDM	17	SPDIFO
9	DVSS	18	PDSW

#### 3.2 PIN-OUT DIAGRAM

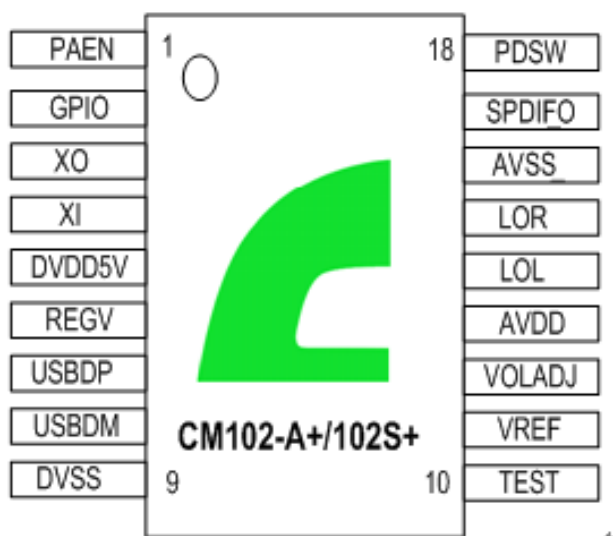



### 3.3 PIN SIGNAL DESCRIPTIONS

Pin #	Symbol	Type	Description
1	PAEN	DI, ST	Power Amplifier Control Input, Connect to a Switch or Pull-High in Normal Operation. H: Enable Power Amplifier (Normal Mode) L: Disable Power Amplifier
2	GPIO	DIO, 8mA, ST, SR, PD	GPIO Pin, Controlled via Vender Specific Command
3	XO	AO	Output Pin for 12MHz Oscillator
4	XI	AI	Input Pin for 12MHz Oscillator
5	DVDD5V	P	5V Power Supply
6	REGV	AO	Regulator output 3.3v
7	USBDP	AIO	USB Data D+
8	USBDM	AIO	USB Data D-
9	DVSS	P	Digital Ground
10	TEST	DI, ST, PD	Test Mode Select Pin, Pull-Down in normal Operation
11	VREF	AO	Connecting to External Decoupling Capacitor for Embedded Bandgap Circuit; 2.25V Output
12	VOLADJ	AI	Analog Volume Control Input from external VR circuit. 0 ~ 2.25V: +12 dB ~ 3 dB / mute 3.5 ~ 5V: 0 dB
13	AVDD	P	5V Power Supply for Analog Circuit
14	LOL	AO	Line Out Left Channel
15	LOR	AO	Line Out Right Channel





<b>CM102-A+/102S+</b>
-----------------------

### USB Stereo Audio Chip for Speaker Integrated

16	AVSS	P	Analog Ground
17	SPDIFO	DO, 8mA, SR	S/PDIF Data Output
18	PDSW	DO, 8mA, SR	Power Down Switch Control Signal Output 1: Normal Mode 0: Power Down Mode (Suspend Mode)

**\*Note:**DI / DO / DIO – Digital Input / Output / Bi-Directional Pad

AI / AO / AIO – Analog Input / Output / Bi-Directional Pad

P – Power Pin

SR – Slew Rate Control

ST – Schmitt Trigger

PD / PU – Pull Down / Pull Up

5VT – 5 Volt Tolerant (3.3V Pad)

## 4. BLOCK DIAGRAM

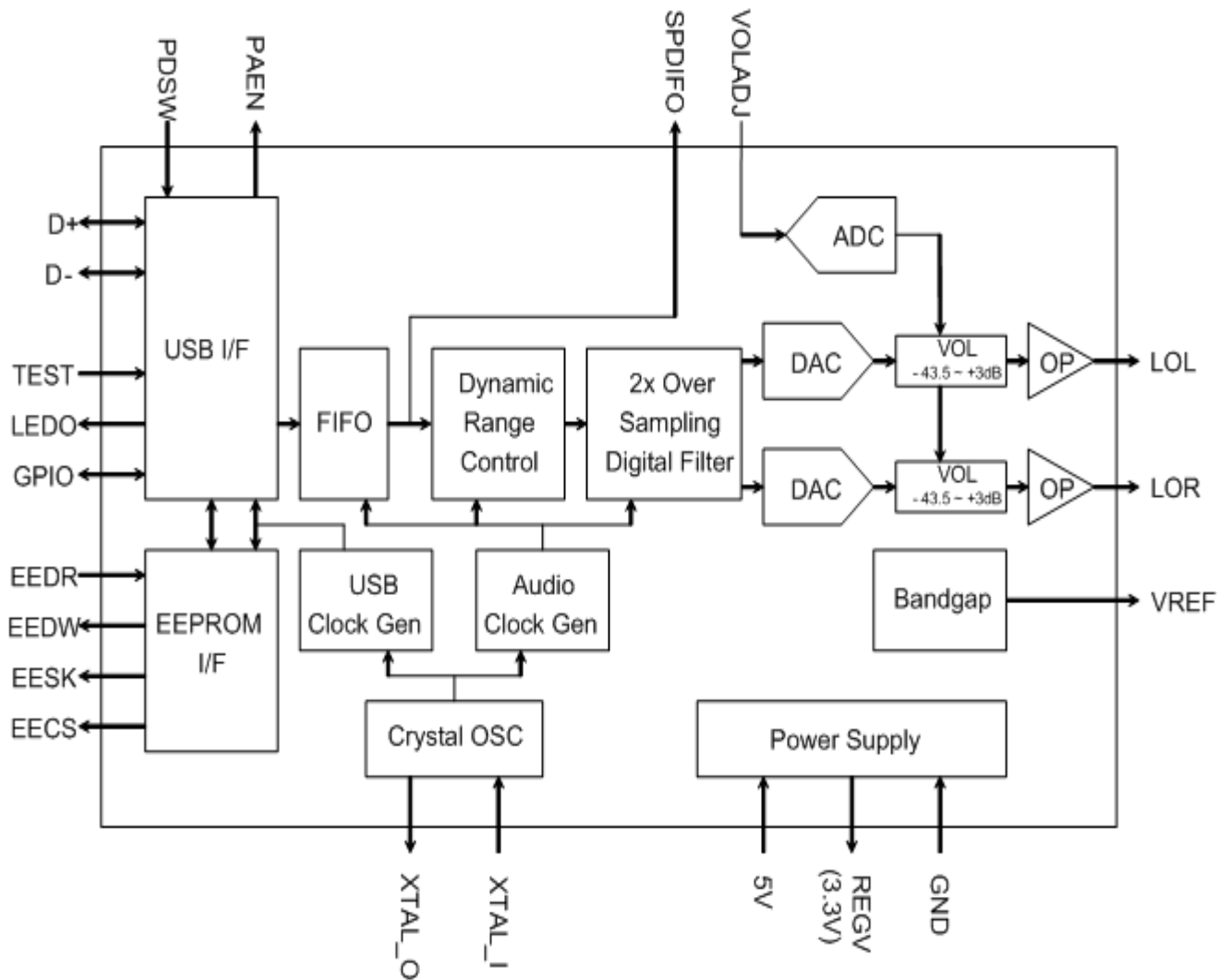

**Block Diagram Of CM102-A+/102S+**

## 5. ORDERING INFORMATION

Model Number	Package	Operating Ambient Temperature	Supply Range
CM102-A+/102S+	18-Pin PDIP	0 o C to +70 o C	DVdd = 5V, AVdd = 5V
	18-Pin SOP	0 o C to +70 o C	DVdd = 5V, AVdd = 5V

**Outline of Dimensions** Dimensions shown in inches and (mm)

### ◆18- Plastic dual-in-line packaging (PDIP)

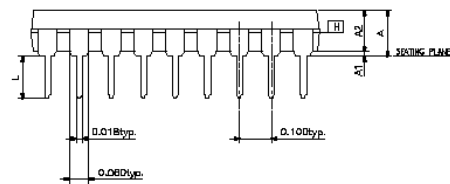
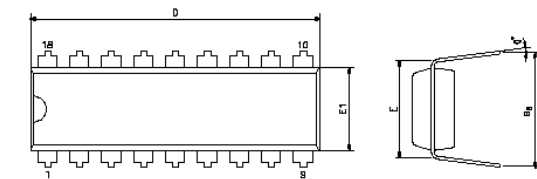

SYMBOLS	MIN.	NOR.	MAX.
A	—	—	0.210
A1	0.015	—	—
A2	0.125	0.130	0.135
D	0.880	0.900	0.920
E	0.300 BSC.		
E1	0.245	0.250	0.255
L	0.115	0.130	0.150
e <sub>B</sub>	0.335	0.355	0.375
θ°	0	7	15

### ◆18- Pin SOP

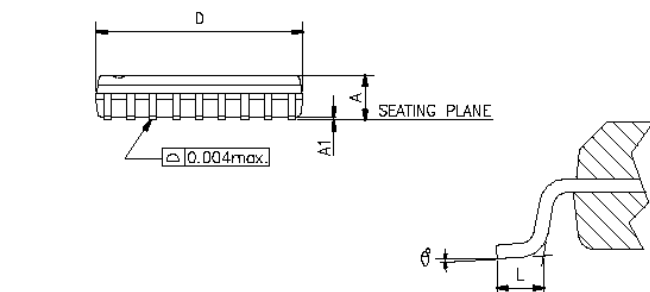
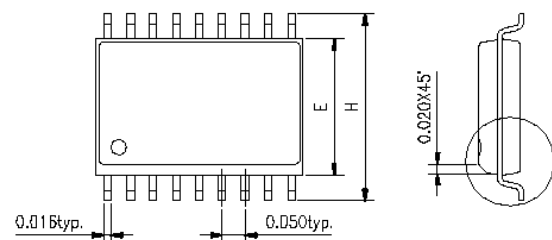

### Mechanical Dimension of CM102-A+

SYMBOLS	MIN.	MAX.
A	0.093	0.104
A1	0.004	0.012
D	0.447	0.463
E	0.291	0.299
H	0.394	0.419
L	0.016	0.050
θ°	0	8

### Mechanical Dimension of CM102S+



## 6. FUNCTION DESCRIPTIONS

### 6.1 USB INTERFACE

#### 6.1.1 DEVICE DESCRIPTOR

Offset	Field	Size	Value (Hex)	Description
0	bLength	1	12	Total 18 Bytes
1	bDescriptorType	1	01	Device Descriptor
2	bcdUSB	2	0110	USB 1.1 compliant.
4	bDeviceClass	1	00	
5	bDeviceSubClass	1	00	
6	bDeviceProtocol	1	00	
7	bMaxPacketSize0	1	08	Endpoint Zero Size = 8 bytes
8	idVendor	2	0D8C	Vendor ID
10	idProduct	2	0103	Product ID
12	bcdDevice	2	0010	Device Release Number
14	iManufacturer	1	01	Index of string descriptor describing manufacturer -> "C-Media INC."
15	iProduct	1	02	Index of string descriptor describing product -> "C-Media USB Audio"
16	iSerialNumber	1	00	Index of string descriptor describing the device's serial number
17	bNumConfigurations	1	01	Configurations number = 1

### 6.1.2 CONFIGURATION DESCRIPTOR

Offset	Field	Size	Value (Hex)	Description
0	bLength	1	09	Total 9 Bytes
1	bDescriptorType	1	02	Configuration Descriptor
2	wTotalLength	2	008D	Total length of data returned for this configuration.
4	bNumInterfaces	1	03	Number of interfaces supported by this Configuration.
5	bConfigurationValue	1	01	
6	iConfiguration	1	00	
7	bmAttributes	1	80	Self-powered without Remote Wakeup
8	bMaxPower	2	FA	Maximum power consumption of the USB. 0xFA=500 mA

### 6.1.3 USB AUDIO TOPOLOGY DIAGRAM

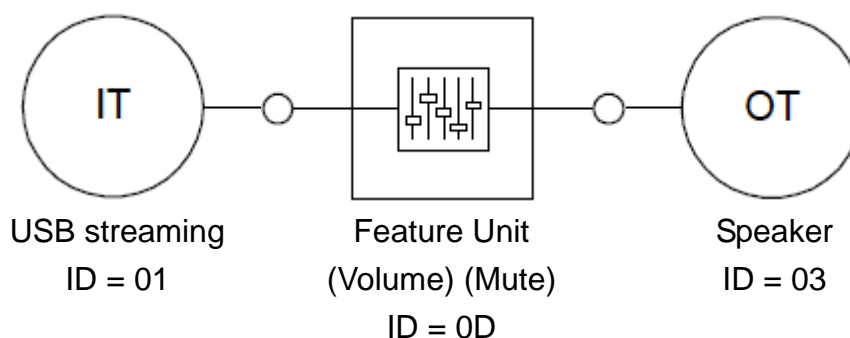

## 6.2 DYNAMIC RANGE CONTROL (DRC)

CM102-A+/102S+ include a new feature called Dynamic Range Control (DRC), and with a default ON setting (Users can still turn it off within the Windows audio advance control panel)

Dynamic range is defined as the difference, in decibels (dB), between the loudest and quietest sounds in any particular piece of audio content. Classical music is a good example, with ranges from piano (soft) to forte to FFF (for extremely loud). Movies also typically have a wide dynamic range, which may cause you to have to turn the volume up and down as scenes change. For example, when watching a movie at home, you may be forced to turn up volume to hear the dialog in a quiet scene, and then quickly turn it down again during a car chase scene that follows. In this way, there may be times in a home theater environment when it would be useful to be able to control the dynamic range.

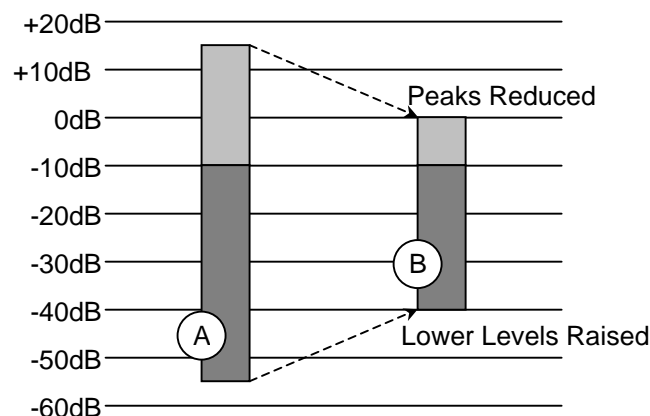

With Dynamic Range Control enabled, the full dynamic range (A) of the program is reduced (B).

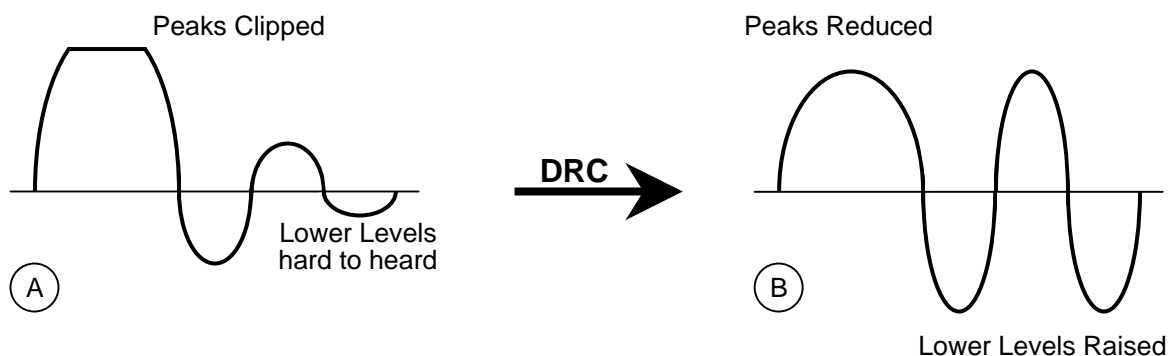

## 7. ELECTRICAL CHARACTERISTICS

### 7.1 ABSOLUTE MAXIMUM RATING

Symbol	Parameter	Value	Unit
Dvmin	Min Digital Supply Voltage	- 0.3	V
Dvmax	Max Digital Supply Voltage	+ 6	V
Avmin	Min Analog Supply Voltage	- 0.3	V
Avmax	Max Analog Supply Voltage	+ 6	V
Dvinout	Voltage on any Digital Input or Output Pin	-0.3 to +5.5	V
Avinout	Voltage on any Analog Input or Output Pin	-0.3 to +5.5	V
T <sub>stg</sub>	Storage Temperature Range	-40 to +125	°C
ESD (HBM)	ESD Human Body Mode	2000	V
ESD (MM)	ESD Machine Mode	200	V
Latchup	Latch Up Test	200	mA

### 7.2 OPERATION CONDITIONS

	Min	Typ	Max	Unit
Analog Supply Voltage	4.5	5.0	5.5	V
Digital Supply Voltage	4.5	5.0	5.5	V
Total Power Consumption	-	-	500	mA
Suspend Mode Power Consumption	-	-	320	uA
Operating ambient temperature	0	-	70	°C

### 7.3 SPERKER IMPEDANCE VS. OUTPUT POWER (PER CHANNEL)

Items	Loading (Ohm)	4 Ohm	8 Ohm	32 Ohm	10K Ohm
Vpp		3.14	3.4	3.635	3.722
Vrms		1.11	1.202	1.285	1.316
W(rms/sin wave)		308 mW	181 mW	52 mW	0.17 mW
W(rms/square wave)		616 mW	361 mW	103 mW	0.35 mW
W(PMPO)		2460 mW	1450 mW	410 mW	1 mW

\***Note1:** Test Condition @ 25°C, 5 Volt +- 10%

\***Note2:** Typical Output with THD+N < 1%; Maximal Output with THD+N < 10%

### 7.4 AUDIO PERFORMANCE

	Min	Typ	Max	Unit
Resolution	--	16	--	Bits
Frequency response @ 48KHz	20	--	20K	Hz
Frequency Response @ 44.1KHz	20	--	20K	Hz
Passband Ripple @ 48 KHz	40	--	9.6K	Hz
Passband Ripple @ 44.1 KHz	40	--	8.8K	Hz
DAC (10K Ohm Loading)				
SNR	--	97.75	--	dB
Dynamic Range	--	96.27	--	dB
THD + N	--	-67.97	--	dB
Output Voltage (rms)	-	1.316	-	Vrms



**CM102-A+/102S+**
**USB Stereo Audio Chip for Speaker Integrated**

DAC (32 Ohm Loading)				
SNR	--	97.68	--	dB
Dynamic Range	--	95.99	--	dB
THD + N	--	-57.82	--	dB
Output Voltage (rms)	-	1.285	-	Vrms
DAC (8 Ohm Loading)				
SNR	--	97.67	--	dB
Dynamic Range	--	96.03	--	dB
THD + N	--	-53.28	--	dB
Output Voltage (rms)	-	1.202	-	Vrms
DAC (4 Ohm Loading)				
SNR	--	97.45	--	dB
Dynamic Range	--	95.89	--	dB
THD + N	--	-52.76	--	dB
Output Voltage (rms)	-	1.11	-	Vrms



## 8. AUDIO PERFORMANCE CURVES

### 8.1 FREQUENCY RESPONSE (10K OHM LOADING)

#### 8.1.1 FREQUENCY RESPONSE @ 44.1 KS/SEC

C-MEDIA Digital Playback (PC-D-A) for Line Output Frequency Response 05/31/05 14:10:33

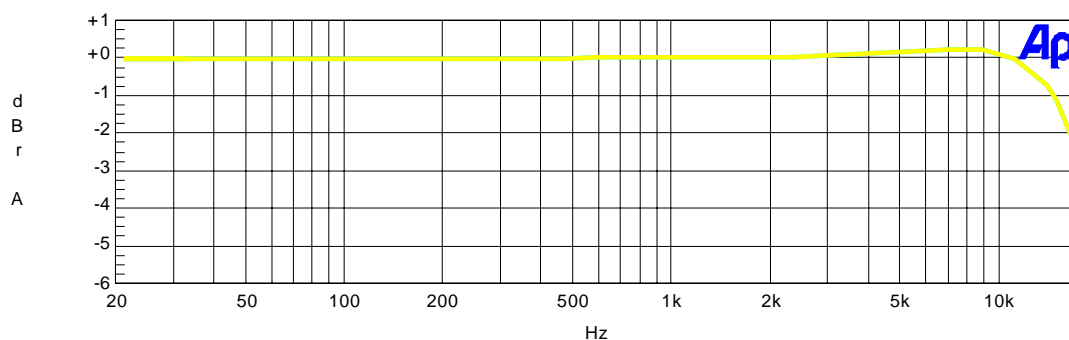

Sweep	Trace	Color	Line Style	Thick	Data	Axis	Comment
1	1	Cyan	Solid	3	Fasttest.Ch.1 Ampl!Normalize	Left	
1	2	Yellow	Solid	3	Fasttest.Ch.2 Ampl!Normalize	Left	

WL-Multitone-44k.at2c

#### 8.1.2 FREQUENCY RESPONSE @ 48 ks/sec

C-MEDIA Digital Playback (PC-D-A) for Line Output Frequency Response 05/31/05 14:07:22

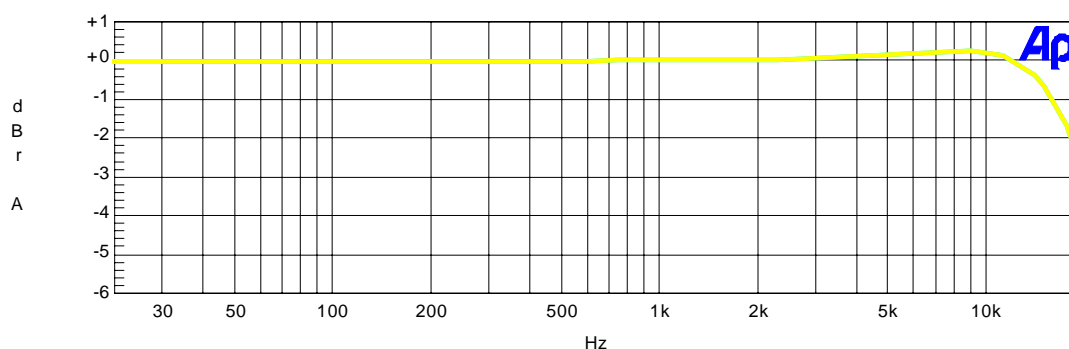

Sweep	Trace	Color	Line Style	Thick	Data	Axis	Comment
1	1	Cyan	Solid	3	Fasttest.Ch.1 Ampl!Normalize	Left	
1	2	Yellow	Solid	3	Fasttest.Ch.2 Ampl!Normalize	Left	

WL-Multitone-48k.at2c

**CM102-A+/102S+**
**USB Stereo Audio Chip for Speaker Integrated**

## 8.2 PASSBAND RIPPLE (10K OHM LOADING)

### 8.2.1 PASSBAND RIPPLE @ 44.1 ks/sec

C-MEDIA Digital Playback (PC-D-A) for Line Output Passband 05/31/05 14:11:07  
Ripple @44.1ks/sec

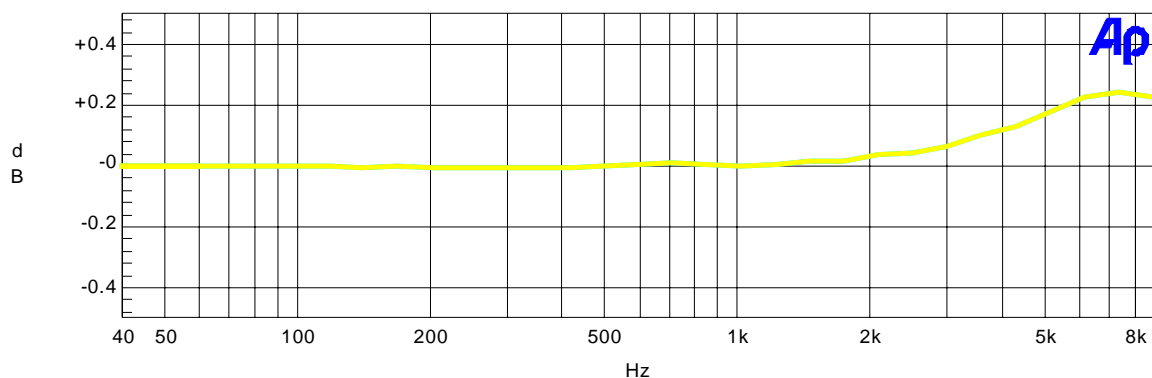

Sweep	Trace	Color	Line Style	Thick	Data	Axis	Comment
1	1	Cyan	Solid	3	Fasttest.Ch.1 Ampl!Normalize	Left	
1	2	Yellow	Solid	3	Fasttest.Ch.2 Ampl!Normalize	Left	

WL-PassbandRipple-M44k.at2c

### 8.2.2 PASSBAND RIPPLE @ 48 ks/sec

C-MEDIA Digital Playback (PC-D-A) for Line Output Passband 05/31/05 14:09:08  
Ripple @48ks/sec

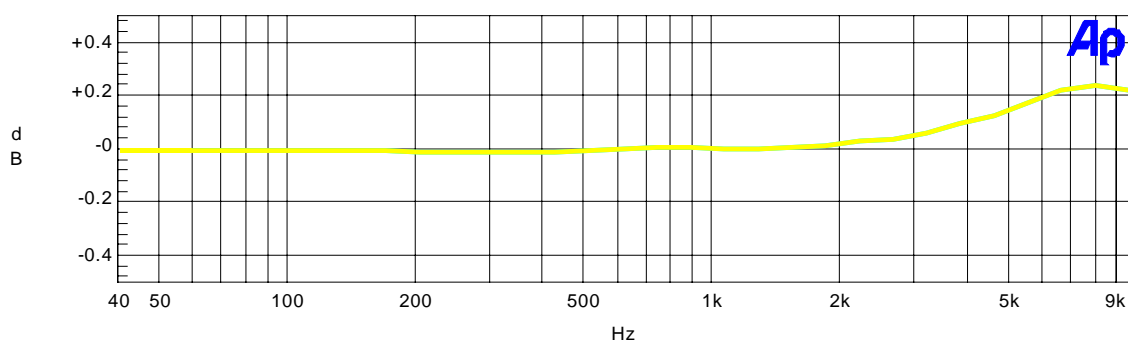

Sweep	Trace	Color	Line Style	Thick	Data	Axis	Comment
1	1	Cyan	Solid	3	Fasttest.Ch.1 Ampl!Normalize	Left	
1	2	Yellow	Solid	3	Fasttest.Ch.2 Ampl!Normalize	Left	

WL-PassbandRipple-M48k.at2c

Date: 09/25/2005

Version: 1.01

### 9. REFERENCE APPLICATION CIRCUIT

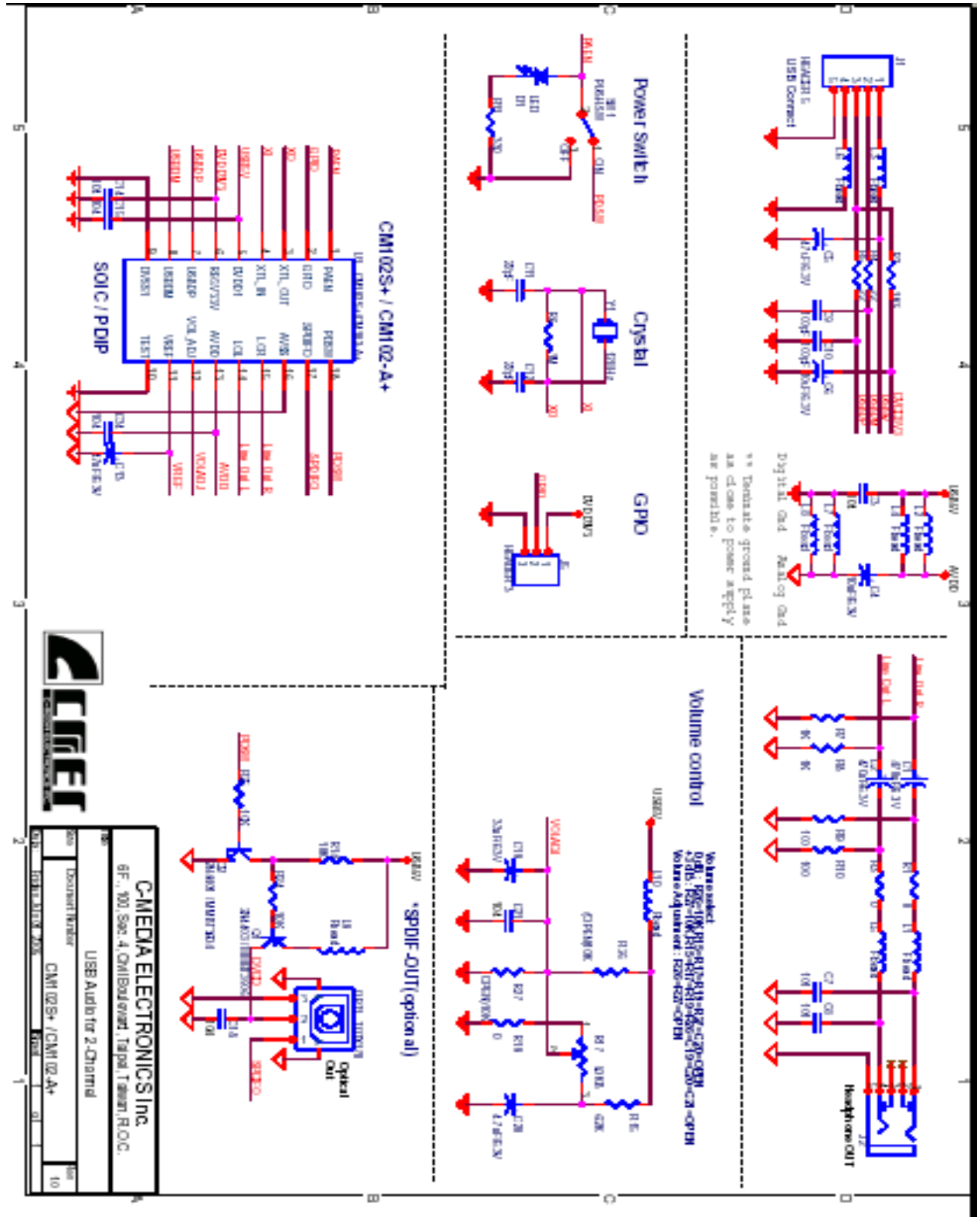



## 10. REFERENCE

- ◆ Universal Serial Bus Specification, Version 2.0
- ◆ Universal Serial Bus Device Class Definition for Audio Devices, Version 1.0.
- ◆ Universal Serial Bus Device Class Definition for Human Interface Devices (HID), Version 1.11

— End of Specifications —

**C-MEDIA ELECTRONICS INC.**

**6F., 100, Sec. 4, Civil Boulevard, Taipei, Taiwan 106 R.O.C.**

**TEL:886-2-8773-1100**

**FAX:886-2-8773-2211**

**E-mail : [sales@cmmedia.com.tw](mailto:sales@cmmedia.com.tw) URL : <http://www.cmmedia.com.tw>**

---

**Date: 09/25/2005**

**Version: 1.01**