

Fast Recovery Diodes, 250 A (MAGN-A-PAK™ Power Modules)

MAGN-A-PAK™
FEATURES

- Fast recovery time characteristics
- Electrically isolated base plate
- Industrial standard package
- Simplified mechanical designs, rapid assembly
- High surge capability
- Large creepage distances
- 3000 V_{RMS} isolating voltage
- UL E78996 approved 
- Lead (Pb)-free
- Designed and qualified for industrial level

**RoHS
COMPLIANT**
PRODUCT SUMMARY

$I_{F(AV)}$	250 A
-------------	-------

DESCRIPTION

The VSK.L240 Series of MAGN-A-PAKs™ uses fast recovery power diodes in four basic configurations. The semiconductors are electrically isolated from the metal base, allowing common heatsinks and compact assemblies to be built. Application includes power supplies, battery chargers, welders, motor controls and general industrial current rectification. These modules are intended for those applications where fast recovery characteristics are required.

MAJOR RATINGS AND CHARACTERISTICS

SYMBOL	CHARACTERISTICS	VSK.L240		UNITS
		S10/S20	S30	
$I_{F(AV)}$		250	240	A
	T_C	100	100	°C
$I_{F(RMS)}$		392	377	A
I_{FSM}	50 Hz	8000	7500	
	60 Hz	8400	7850	
I^2t	50 Hz	322	280	kA ² s
	60 Hz	294	256	
$I^2\sqrt{t}$		3220	2800	kA ² √s
V_{RRM}		Up to 2500		V
T_J	Range	- 40 to 150		°C

VSK.L240 Series



Vishay High Power Products Fast Recovery Diodes, 250 A
(MAGN-A-PAK™ Power Modules)

ELECTRICAL SPECIFICATIONS

VOLTAGE RATINGS					
TYPE NUMBER	VOLTAGE CODE	t _{rr} CODE	V _{RRM} , MAXIMUM REPETITIVE PEAK REVERSE VOLTAGE V	V _{RSM} , MAXIMUM NON-REPETITIVE PEAK REVERSE VOLTAGE V	I _{RRM} MAXIMUM AT 150 °C mA
VSK.L240	06	S10	600	700	50
	10	S10	1000	1100	
	12	S20	1200	1300	
	14	S20	1400	1500	
	20	S30	2000	2100	
	25	S30	2500	2600	

FORWARD CONDUCTION						
PARAMETER	SYMBOL	TEST CONDITIONS		VSK.L240		UNITS
				S10/S20	S30	
Maximum average forward current at case temperature	I _{F(AV)}	180° conduction, half sine wave		250	240	A
				100	100	°C
Maximum RMS forward current	I _{F(RMS)}	As AC switch		392	377	A
Maximum peak, one-cycle forward non-repetitive, surge current	I _{FSM}	t = 10 ms	No voltage reapplied	8000	7500	
		t = 8.3 ms		8400	7850	
		t = 10 ms	100 % V _{RRM} reapplied	6750	6300	
		t = 8.3 ms		7100	6600	
Maximum I ² t for fusing	I ² t	t = 10 ms	No voltage reapplied	322	280	kA ² s
		t = 8.3 ms		294	256	
		t = 10 ms	100 % V _{RRM} reapplied	228	198	
		t = 8.3 ms		208	181	
Maximum I ² √t for fusing	I ² √t	t = 0.1 to 10 ms, no voltage reapplied		3220	2800	kA ² √s
Low level value of threshold voltage	V _{F(TO)1}	(16.7 % × π × I _{F(AV)}) < I < π × I _{F(AV)} , T _J = T _J maximum		0.98	0.98	V
High level value of threshold voltage	V _{F(TO)2}	(I > π × I _{F(AV)}), T _J = T _J maximum		1.31	1.31	
Low level value of forward slope resistance	r _{f1}	(16.7 % × π × I _{F(AV)}) < I < π × I _{F(AV)} , T _J = T _J maximum		0.75	0.97	mΩ
High level value of forward slope resistance	r _{f2}	(I > π × I _{F(AV)}), T _J = T _J maximum		0.41	0.60	
Maximum forward voltage drop	V _{FM}	I _{FM} = 800 A, T _J = 150 °C, t _p = 10 ms Average power = V _{F(TO)} × I _{F(AV)} + r _f × (I _{F(RMS)}) ²		1.57	1.75	V



RECOVERY CHARACTERISTICS								
CODE	MAXIMUM VALUE AT $T_J = 25\text{ }^\circ\text{C}$	TEST CONDITIONS			TYPICAL VALUES AT $T_J = 150\text{ }^\circ\text{C}$			
	t_{rr} AT 25 % I_{RRM} (μs)	I_{pk} SQUARE PULSE (A)	di/dt (A/ μs)	V_r (V)	t_{rr} AT 25 % I_{RRM} (μs)	Q_{rr} (μC)	I_r (A)	
S10	1.0	500	100	- 50	2.7	135	100	
S20	2.0				3.5	250	145	
S30	3.0				3.6	360	200	

BLOCKING				
PARAMETER	SYMBOL	TEST CONDITIONS	VALUES	UNITS
Maximum peak reverse leakage current	I_{RRM}	$T_J = 150\text{ }^\circ\text{C}$, leakage current	50	mA
RMS insulation voltage	V_{INS}	50 Hz, circuit to base, all terminals shorted, $25\text{ }^\circ\text{C}$, $t = 1\text{ s}$	3000	V

THERMAL AND MECHANICAL SPECIFICATIONS				
PARAMETER	SYMBOL	TEST CONDITIONS	VALUES	UNITS
Maximum junction operating and storage temperature range	T_J, T_{Stg}		- 40 to 150	$^\circ\text{C}$
Maximum internal thermal resistance, junction to case per junction	R_{thJC}	DC operation	0.125	K/W
Thermal resistance, case to heatsink per module	R_{thCS}	Mounting surface flat, smooth and greased	0.02	
Mounting torque $\pm 10\%$	MAP to heatsink	A mounting compound is recommended and the torque should be rechecked after a period of about 3 hours to allow for the spread of the compound.	4 to 6	Nm
	busbar to MAP		8 to 10	
Approximate weight			850	g
			30	oz.
Case style			MAGN-A-PAK	

ΔR CONDUCTION PER JUNCTION				
CONDUCTION ANGLE	SINUSOIDAL CONDUCTION	RECTANGULAR CONDUCTION	TEST CONDITIONS	UNITS
180°	0.008	0.007	$T_J = T_J$ maximum	K/W
120°	0.010	0.011		
90°	0.013	0.015		
60°	0.019	0.020		
30°	0.032	0.033		

Note

- The table above shows the increment of thermal resistance R_{thJC} when devices operate at different conduction angles than DC

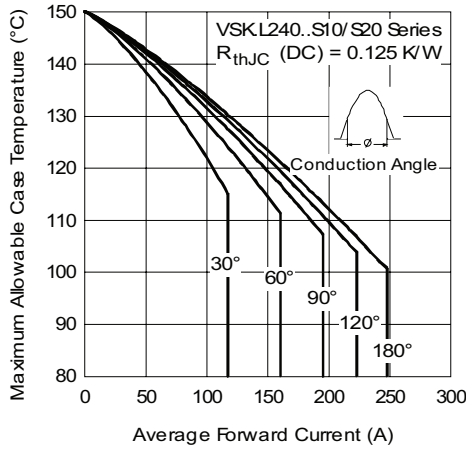

Fig. 1 - Current Ratings Characteristics

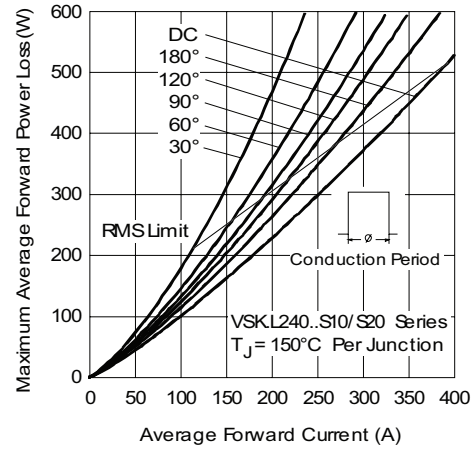

Fig. 4 - Forward Power Loss Characteristics

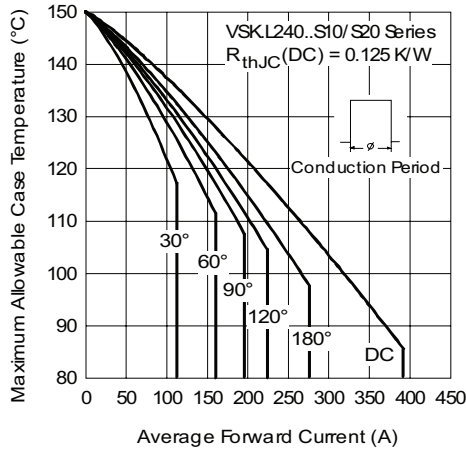

Fig. 2 - Current Ratings Characteristics

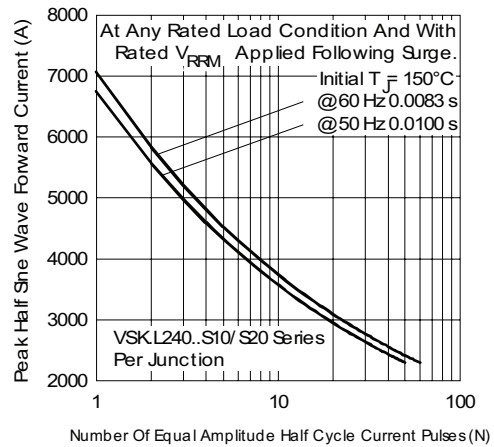

Fig. 5 - Maximum Non-Repetitive Surge Current

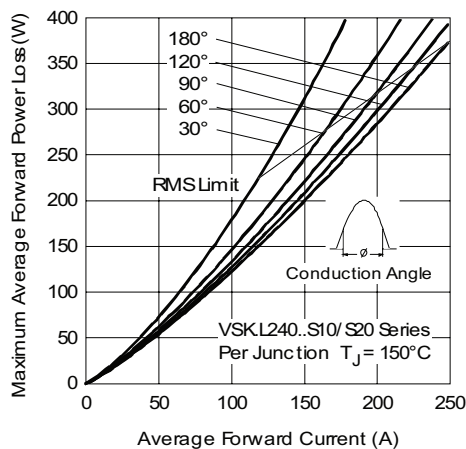

Fig. 3 - Forward Power Loss Characteristics

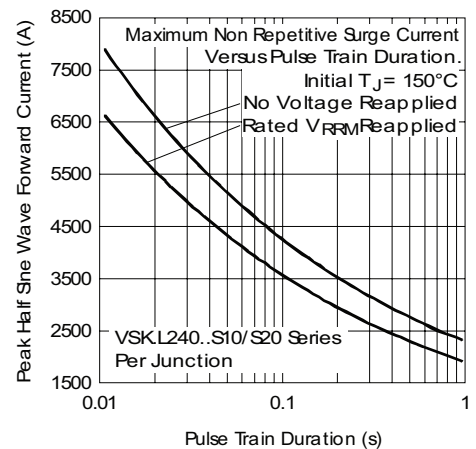

Fig. 6 - Maximum Non-Repetitive Surge Current



Fast Recovery Diodes, 250 A Vishay High Power Products (MAGN-A-PAK™ Power Modules)

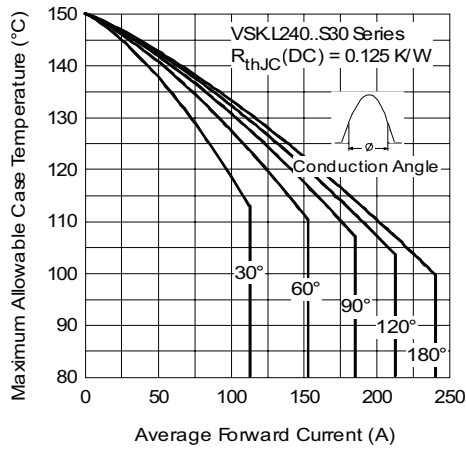

Fig. 7 - Current Ratings Characteristics

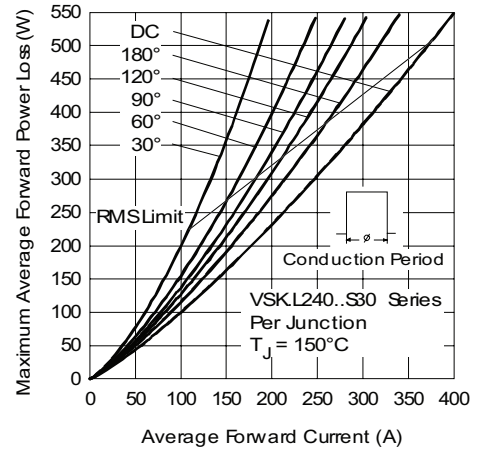

Fig. 10 - Forward Power Loss Characteristics

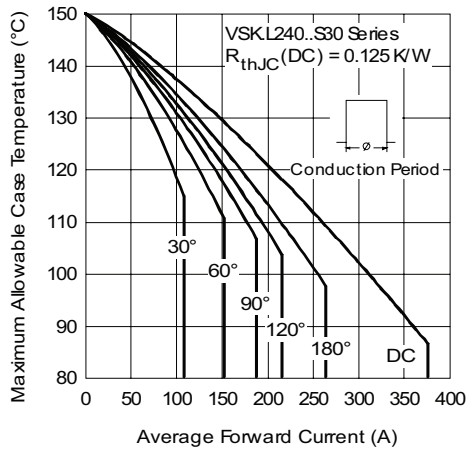

Fig. 8 - Current Ratings Characteristics

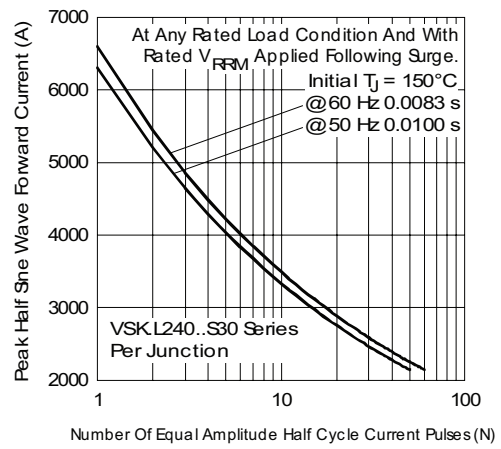

Fig. 11 - Maximum Non-Repetitive Surge Current

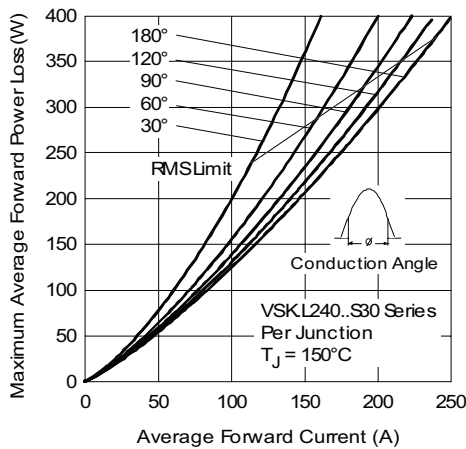

Fig. 9 - Forward Power Loss Characteristics

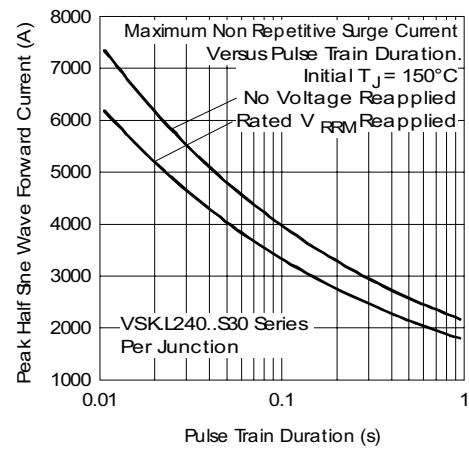

Fig. 12 - Maximum Non-Repetitive Surge Current

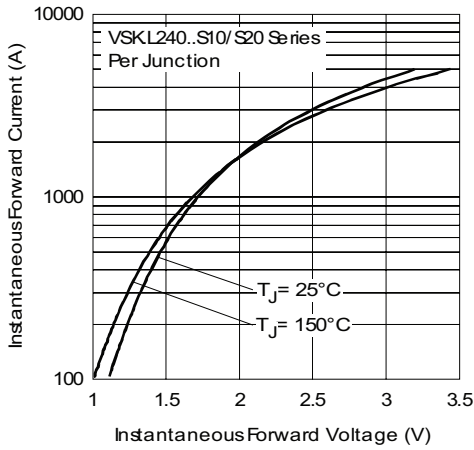

Fig. 13 - Forward Voltage Drop Characteristics

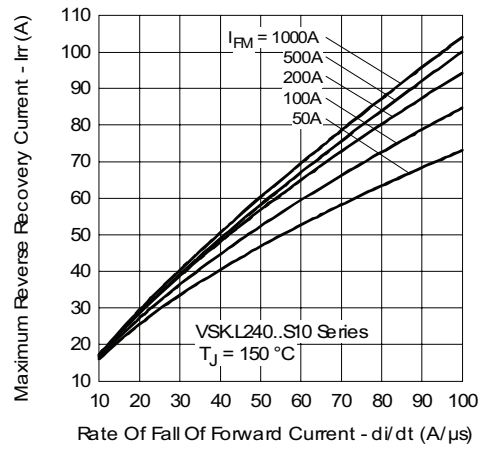

Fig. 16 - Reverse Recovery Current Characteristics

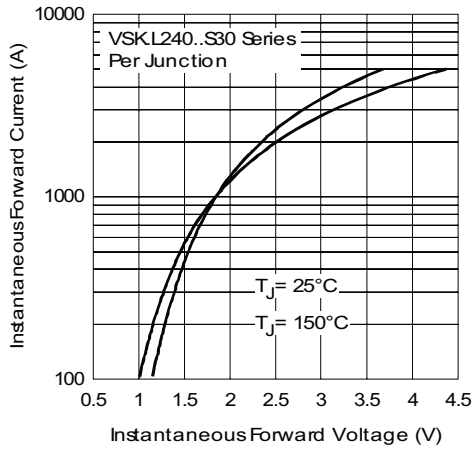

Fig. 14 - Forward Voltage Drop Characteristics

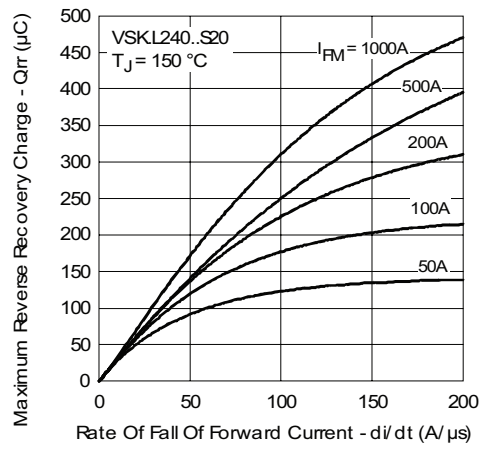

Fig. 17 - Reverse Recovery Charge Characteristics

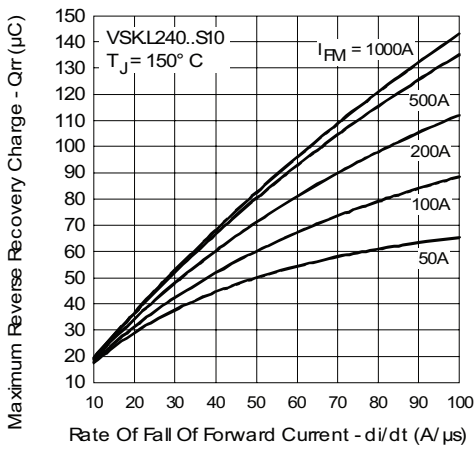

Fig. 15 - Reverse Recovery Charge Characteristics

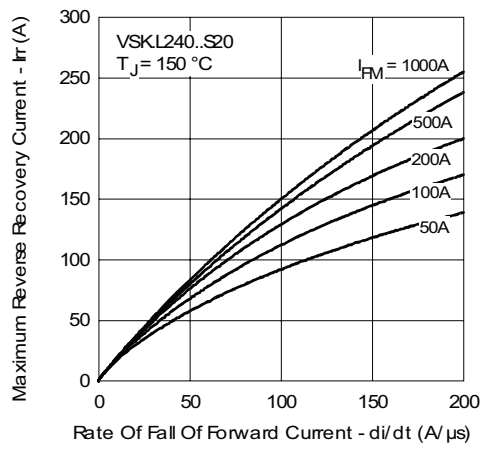

Fig. 18 - Reverse Recovery Current Characteristics



Fast Recovery Diodes, 250 A Vishay High Power Products
(MAGN-A-PAK™ Power Modules)

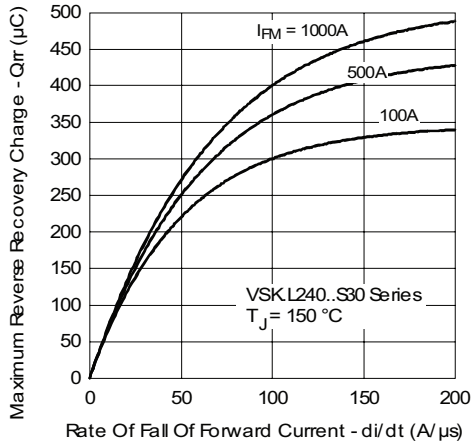

Fig. 19 - Reverse Recovery Charge Characteristics

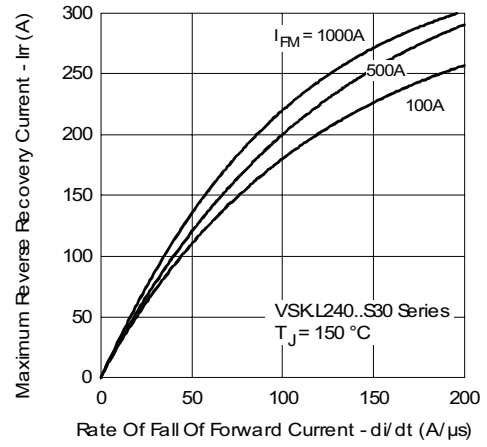

Fig. 20 - Reverse Recovery Current Characteristics

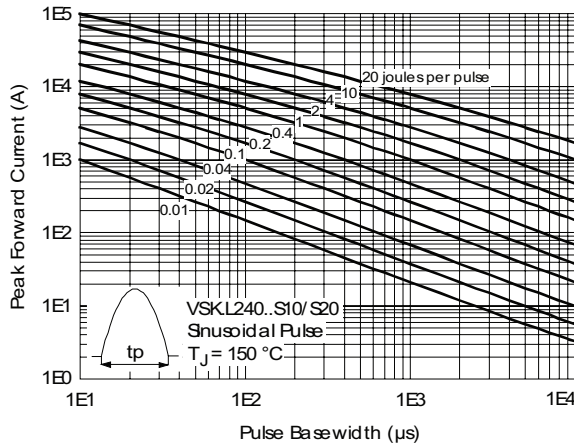

Fig. 21 - Maximum Forward Energy Power Loss Characteristics

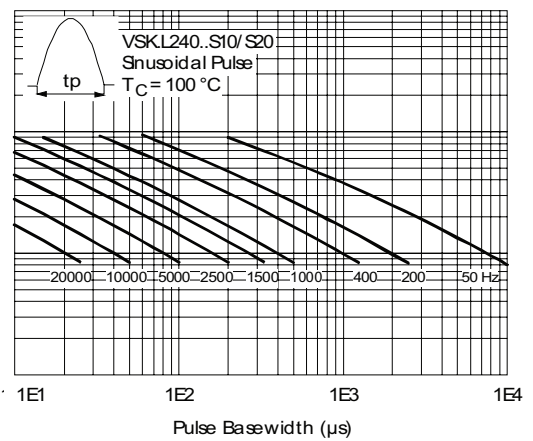
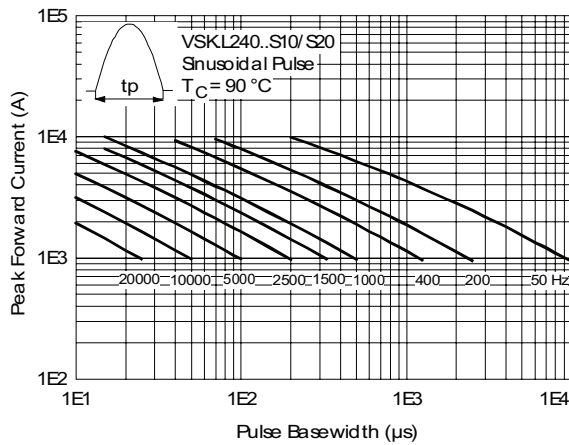
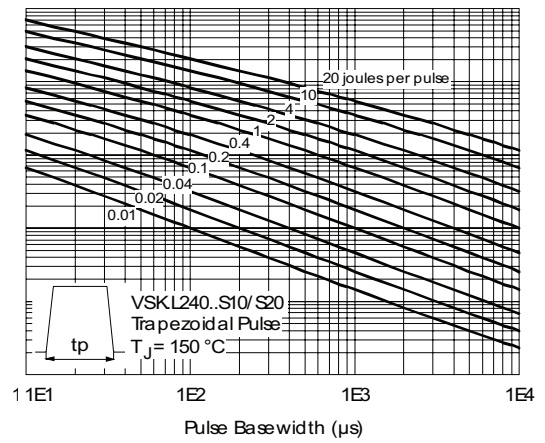

Fig. 22 - Frequency Characteristics

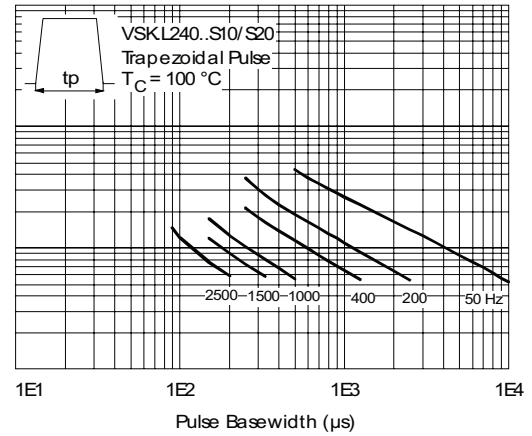
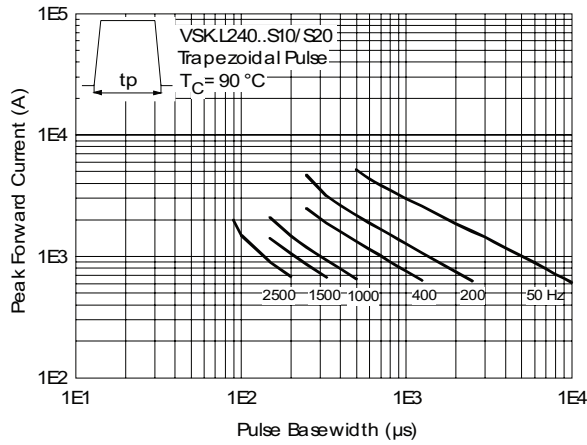

Fig. 23 - Frequency Characteristics

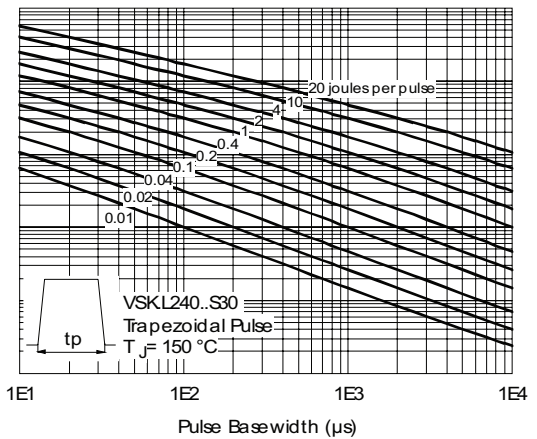
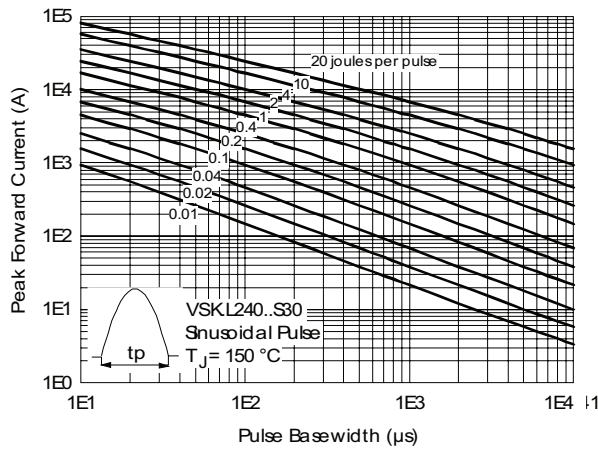

Fig. 24 - Maximum Forward Energy Power Loss Characteristics

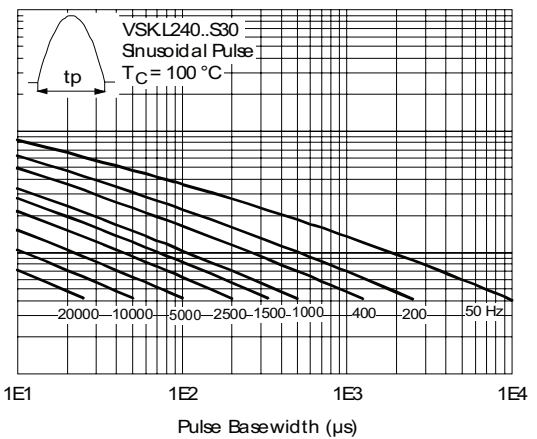
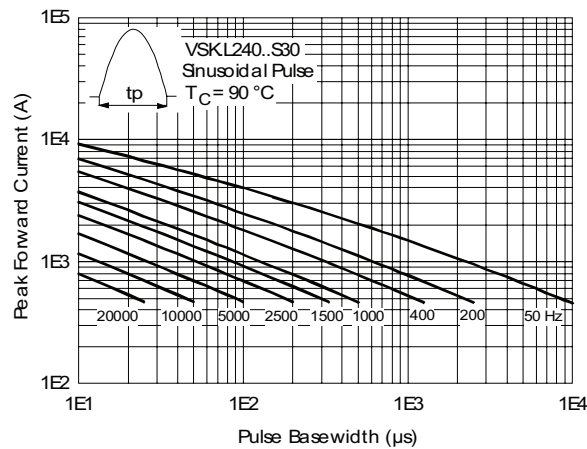

Fig. 25 - Frequency Characteristics

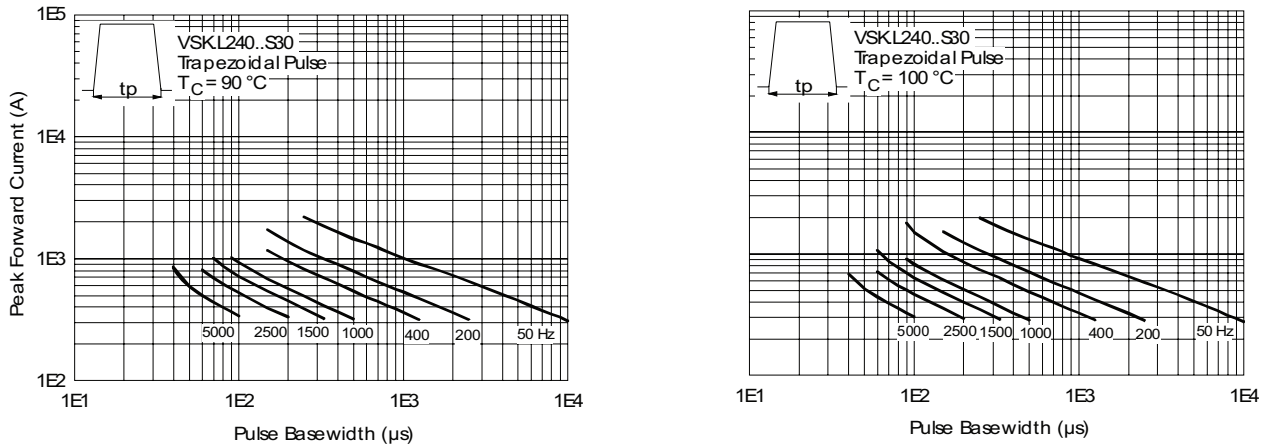

Fig. 26 - Frequency Characteristics

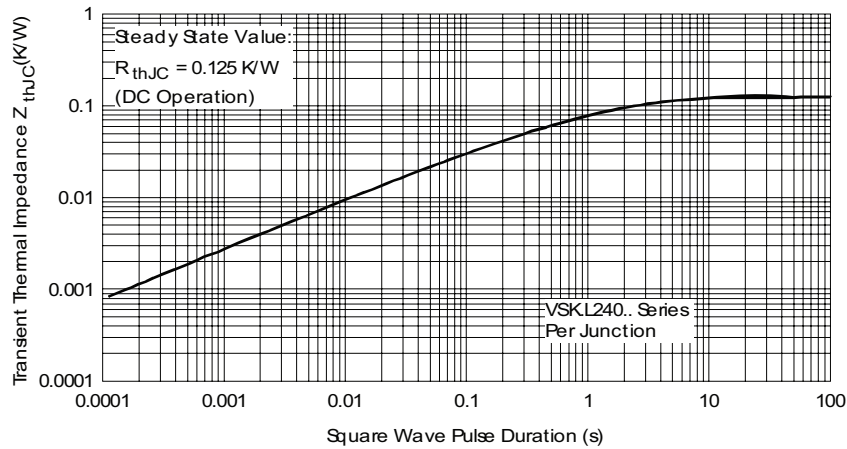

Fig. 27 - Thermal Impedance Z_{thJC} Characteristics

ORDERING INFORMATION TABLE

Device code	VSK	D	L	240	-	25	S30
	①	②	③	④		⑤	⑥

- 1** - Module type
- 2** - Circuit configuration (see end of datasheet)
- 3** - L = Fast recovery diode
- 4** - Current rating
- 5** - Voltage code x 100 = V_{RRM} (see Voltage Ratings table)
- 6** - t_{rr} code (see Recovery Characteristics table)

S10 = 1000 ns
S20 = 2000 ns
S30 = 3000 ns

VSK.L240 Series



Vishay High Power Products Fast Recovery Diodes, 250 A
(MAGN-A-PAK™ Power Modules)

CIRCUIT CONFIGURATION

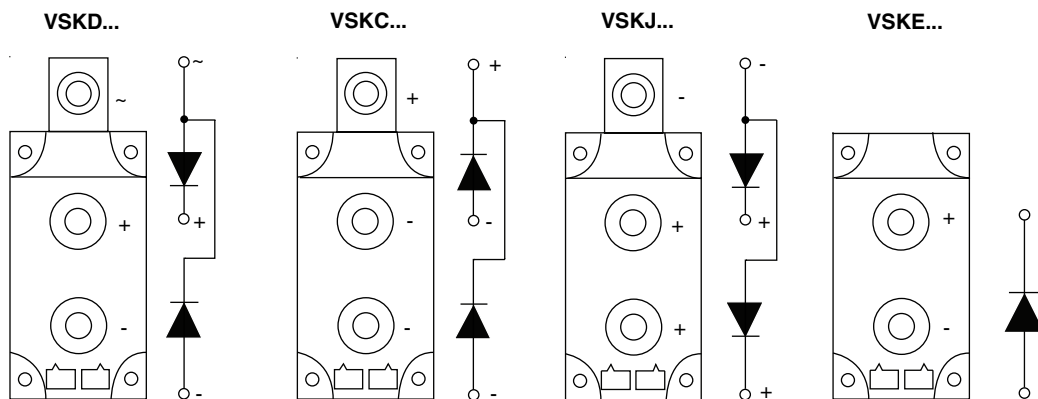

LINKS TO RELATED DOCUMENTS

Dimensions	http://www.vishay.com/doc?95086
------------	---



Disclaimer

All product specifications and data are subject to change without notice.

Vishay Intertechnology, Inc., its affiliates, agents, and employees, and all persons acting on its or their behalf (collectively, "Vishay"), disclaim any and all liability for any errors, inaccuracies or incompleteness contained herein or in any other disclosure relating to any product.

Vishay disclaims any and all liability arising out of the use or application of any product described herein or of any information provided herein to the maximum extent permitted by law. The product specifications do not expand or otherwise modify Vishay's terms and conditions of purchase, including but not limited to the warranty expressed therein, which apply to these products.

No license, express or implied, by estoppel or otherwise, to any intellectual property rights is granted by this document or by any conduct of Vishay.

The products shown herein are not designed for use in medical, life-saving, or life-sustaining applications unless otherwise expressly indicated. Customers using or selling Vishay products not expressly indicated for use in such applications do so entirely at their own risk and agree to fully indemnify Vishay for any damages arising or resulting from such use or sale. Please contact authorized Vishay personnel to obtain written terms and conditions regarding products designed for such applications.

Product names and markings noted herein may be trademarks of their respective owners.