

SD3443/5443

Silicon Phototransistor

FEATURES

- TO-46 metal can package
- Choice of flat window or lensed package
- 90° or 18° (nominal) acceptance angle option
- Wide operating temperature range (-55°C to +125°C)
- External base connection for added control
- High sensitivity
- Mechanically and spectrally matched to SE3450/5450, SE3455/5455 and SE3470/5470 infrared emitting diodes

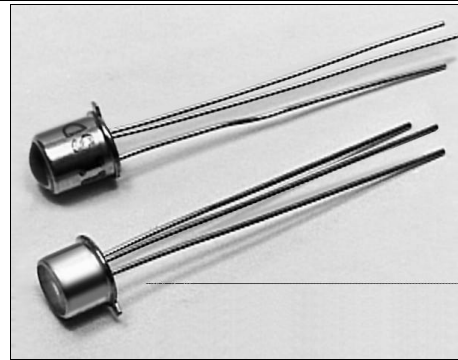

INFRA-57.TIF

DESCRIPTION

The SD3443/5443 series consists of an NPN silicon phototransistor mounted in a TO-46 metal can package. The SD3443 has flat window cans providing a wide acceptance angle, while the SD5443 has glass lensed cans providing a narrow acceptance angle. The TO-46 packages are ideally suited for operation in hostile environments.

The base is connected on all SD3443 and SD5433 standard products.

OUTLINE DIMENSIONS in inches (mm)

Tolerance	3 plc decimals	±0.005(0.12)
	2 plc decimals	±0.020(0.51)

SD3443

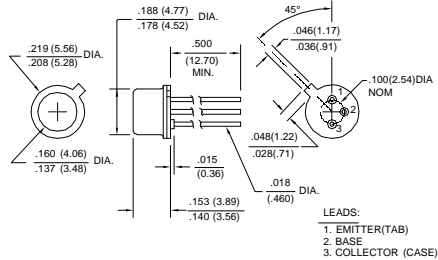

DIM_015.d54

SD5443

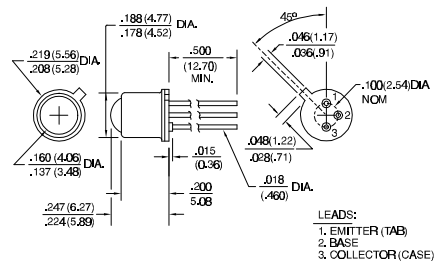

DIM_15b.d54

SD3443/5443

Silicon Phototransistor

ELECTRICAL CHARACTERISTICS (25°C unless otherwise noted)

PARAMETER	SYMBOL	MIN	TYP	MAX	UNITS	TEST CONDITIONS
Light Current	I_L				mA	$V_{CE}=5\text{ V}$ $H=5\text{ mW/cm}^2$ (1)
SD3443-001		0.50				
SD3443-002		1.00				
SD3443-003		2.00				
SD5443-001		1.00				
SD5443-002		4.00				
SD5443-003		8.00				
SD5443-004		16.0				
Collector Dark Current	I_{CEO}			100	nA	$V_{CE}=10\text{ V}$, $H=0$
Collector-Emitter Breakdown Voltage	$V_{(BR)CEO}$	30			V	$I_C=100\text{ }\mu\text{A}$
Emitter-Collector Breakdown Voltage	$V_{(BR)ECO}$	5.0			V	$I_E=100\text{ }\mu\text{A}$
Collector-Emitter Saturation Voltage	$V_{CE(sAT)}$			0.4	V	$I_C=0.4\text{ mA}$ $H=5\text{ mW/cm}^2$
Angular Response (2)	\emptyset				degr.	$I_F=\text{Constant}$
SD3443			90			
SD5443			18			
Rise And Fall Time	t_r , t_f		15		μs	$V_{CC}=5\text{ V}$, $I_L=1\text{ mA}$ $R_L=1000\text{ }\Omega$

Notes

- The radiation source is a tungsten lamp operating at a color temperature of 2870°K.
- Angular response is defined as the total included angle between the half sensitivity points.

ABSOLUTE MAXIMUM RATINGS

(25°C Free-Air Temperature unless otherwise noted)

Collector-Emitter Voltage	30 V
Emitter-Collector Voltage	5 V
Power Dissipation	150 mW (1)
Operating Temperature Range	-55°C to 125°C
Storage Temperature Range	-65°C to 150°C
Soldering Temperature (10 sec)	260°C

Notes

- Derate linearly from 25°C free-air temperature at the rate of 1.43 mW/°C.

SCHEMATIC

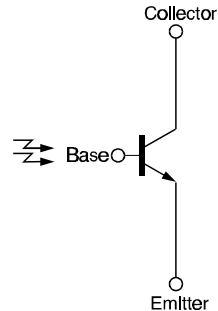

Honeywell reserves the right to make changes in order to improve design and supply the best products possible.

Honeywell

109

SD3443/5443

Silicon Phototransistor

SWITCHING TIME TEST CIRCUIT

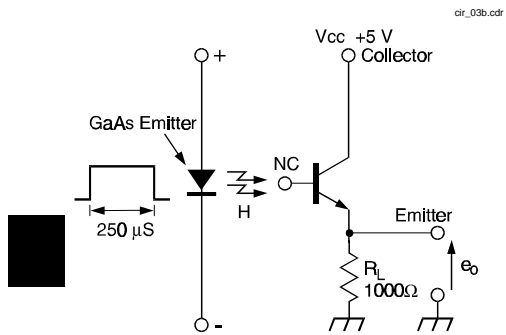

Fig. 1 Responsivity vs Angular Displacement (SD3443)

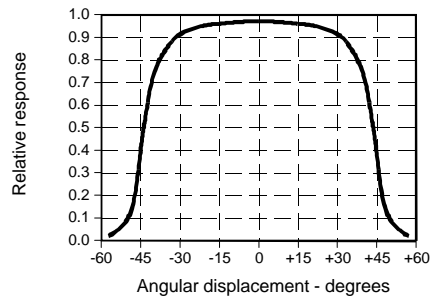
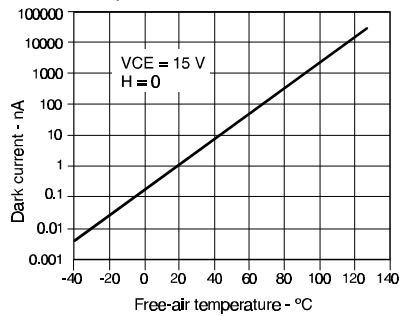

Fig. 3 Dark Current vs Temperature



SWITCHING WAVEFORM

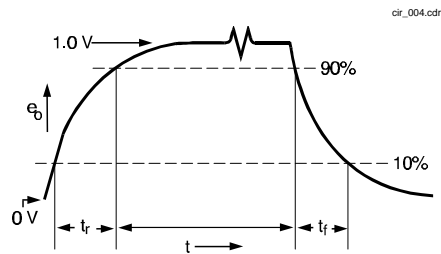

Fig. 2 Responsivity vs Angular Displacement (SD5443)

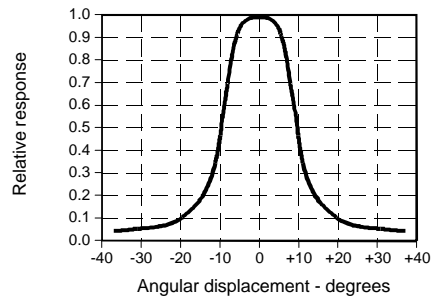
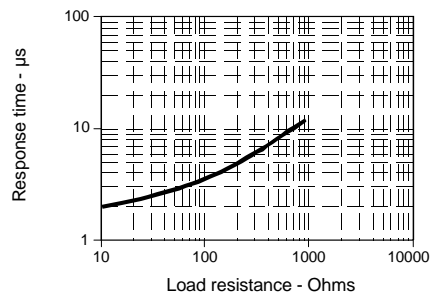

Fig. 4 Non-Saturated Switching Time vs Load Resistance



SD3443/5443

Silicon Phototransistor

Fig. 5 Spectral Responsivity

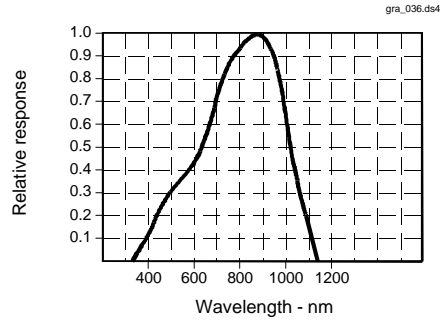

Fig. 6 Coupling Characteristics SE3450 with SD3443

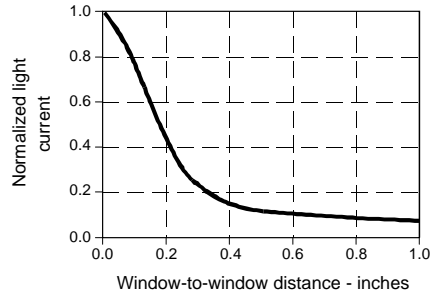

Fig. 7 Coupling Characteristics SE5450 with SD5443

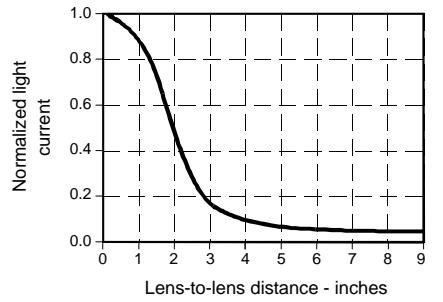
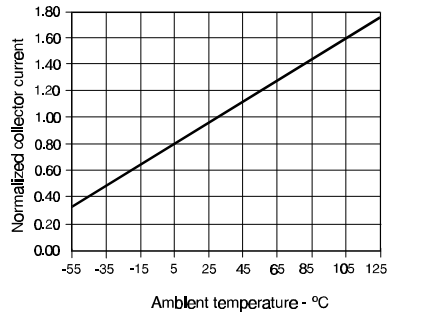

Fig. 8 Collector Current vs Ambient Temperature



All Performance Curves Show Typical Values

Honeywell reserves the right to make changes in order to improve design and supply the best products possible.

Honeywell