

**Features**

- Reliable, Low-Cost HBT Design
- 12.5dB Gain
- High P1dB of +15.8dBm at 6GHz
- Single Power Supply Operation
- 50Ω I/O Matched for High Frequency Use

**Applications**

- Narrow and Broadband Commercial and Military Radio Designs
- Linear and Saturated Amplifiers
- Gain Stage or Driver Amplifiers for MWRadio/Optical Designs (PTP/PMP/LMDS/UNII/VSAT/WLAN/Cellular/DWDM)

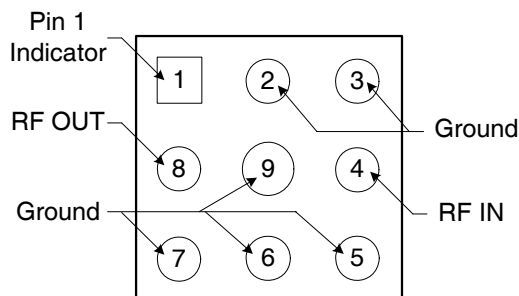

Functional Block Diagram

**Product Description**

The NBB-312 cascadable broadband InGaP/GaAs MMIC amplifier is a low-cost, high-performance solution for general purpose RF and microwave amplification needs. This 50Ω gain block is based on a reliable HBT proprietary MMIC design, providing unsurpassed performance for small-signal applications. Designed with an external bias resistor, the NBB-312 provides flexibility and stability. The NBB-310 is packaged in a low-cost, surface-mount ceramic package, providing ease of assembly for high-volume tape-and-reel requirements. It is available in either 1,000 or 3,000 piece-per-reel quantities. Connectorized evaluation board designs optimized for high frequency are also available for characterization purposes.

**Ordering Information**

NBB-312	Cascadable Broadband GaAs MMIC Amplifier DC to 12GHz
NBB-312-T1	Tape & Reel, 1000 Pieces
NBB-312-E	Fully Assembled Evaluation Board
NBB-X-K1	Extended Frequency InGaP Amp Designer's Tool Kit

**Optimum Technology Matching® Applied**

- |   |                                      |                                     |                                   |
|---|--------------------------------------|-------------------------------------|-----------------------------------|
| <input type="checkbox"/> GaAs HBT             | <input type="checkbox"/> SiGe BiCMOS | <input type="checkbox"/> GaAs pHEMT | <input type="checkbox"/> GaN HEMT |
| <input type="checkbox"/> GaAs MESFET          | <input type="checkbox"/> Si BiCMOS   | <input type="checkbox"/> Si CMOS    |                                   |
| <input checked="" type="checkbox"/> InGaP HBT | <input type="checkbox"/> SiGe HBT    | <input type="checkbox"/> Si BJT     |                                   |

RF MICRO DEVICES®, RFMD®, Optimum Technology Matching®, Enabling Wireless Connectivity™, PowerStar®, POLARIS™ TOTAL RADIO™ and UltimateBlue™ are trademarks of RFMD, LLC. BLUETOOTH is a trademark owned by Bluetooth SIG, Inc., U.S.A. and licensed for use by RFMD. All other trade names, trademarks and registered trademarks are the property of their respective owners. ©2006, RF Micro Devices, Inc.

## Absolute Maximum Ratings

Parameter	Rating	Unit
RF Input Power	+20	dBm
Power Dissipation	350	mW
Device Current	70	mA
Channel Temperature	200	°C
Operating Temperature	-45 to +85	°C
Storage Temperature	-65 to +150	°C

Exceeding any one or a combination of these limits may cause permanent damage.



**Caution!** ESD sensitive device.

The information in this publication is believed to be accurate and reliable. However, no responsibility is assumed by RF Micro Devices, Inc. ("RFMD") for its use, nor for any infringement of patents, or other rights of third parties, resulting from its use. No license is granted by implication or otherwise under any patent or patent rights of RFMD. RFMD reserves the right to change component circuitry, recommended application circuitry and specifications at any time without prior notice.

RoHS status based on EUDirective2002/95/EC (at time of this document revision).

Parameter	Specification			Unit	Condition
	Min.	Typ.	Max.		
<b>Overall</b>					$V_D = +5V, I_{CC} = 50mA, Z_0 = 50\Omega, T_A = +25^\circ C$
Small Signal Power Gain, S21	12.5	12.9		dB	f=0.1GHz to 1.0GHz
	12.0	12.9		dB	f=1.0GHz to 4.0GHz
	11.4	11.7		dB	f=4.0GHz to 8.0GHz
	9.0	9.7		dB	f=8.0GHz to 12.0GHz
Gain Flatness, GF		+0.6		dB	f=0.1GHz to 8.0GHz
Input VSWR		1.2:1			f=0.1GHz to 7.0GHz
		1.65:1			f=7.0GHz to 10.0GHz
		2.0:1			f=10.0GHz to 12.0GHz
Output VSWR		1.5:1			f=0.1GHz to 12.0GHz
Bandwidth, BW		11.0		GHz	BW3 (3dB)
Output Power @ -1dB Compression, P1dB		14.9		dBm	f=2.0GHz
		15.8		dBm	f=6.0GHz
		15.0		dBm	f=8.0GHz
		12.0		dBm	f=12.0GHz
Noise Figure, NF		4.9		dB	f=3.0GHz
Third Order Intercept, IP3		+24.0		dBm	f=2.0GHz
Reverse Isolation, S12		-15.6		dB	f=0.1GHz to 12.0GHz
Device Voltage, $V_D$	4.7	5.0	5.3	V	
Gain Temperature Coefficient, $\delta G_T / \delta T$		-0.0015		dB/°C	
<b>MTTF versus Temperature @ <math>I_{CC} = 50mA</math></b>					
Case Temperature		85		°C	
Junction Temperature		123		°C	
MTTF		>1,000,000		hours	
<b>Thermal Resistance</b>					
$\theta_{JC}$		152		°C/W	$\frac{J_T - T_{CASE}}{V_D \cdot I_{CC}} = \theta_{JC} (^\circ C / Watt)$

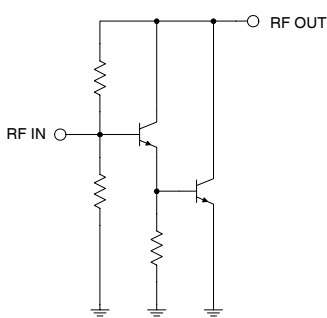
Pin	Function	Description	Interface Schematic
1	GND	Ground connection. For best performance, keep traces physically short and connect immediately to ground plane.	
2	GND	Same as pin 1.	
3	GND	Same as pin 1.	
4	RF IN	RF input pin. This pin is NOT internally DC blocked. A DC blocking capacitor, suitable for the frequency of operation, should be used in most applications. DC coupling of the input is not allowed, because this will override the internal feedback loop and cause temperature instability.	
5	GND	Same as pin 1.	
6	GND	Same as pin 1.	
7	GND	Same as pin 1.	
8	RF OUT	RF output and bias pin. Biasing is accomplished with an external series resistor and choke inductor to $V_{CC}$ . The resistor is selected to set the DC current into this pin to a desired level. The resistor value is determined by the following equation:  $R = \frac{(V_{CC} - V_{DEVICE})}{I_{CC}}$ <p>Care should also be taken in the resistor selection to ensure that the current into the part never exceeds maximum datasheet operating current over the planned operating temperature. This means that a resistor between the supply and this pin is always required, even if a supply near 8.0V is available, to provide DC feedback to prevent thermal runaway. Alternatively, a constant current supply circuit may be implemented. Because DC is present on this pin, a DC blocking capacitor, suitable for the frequency of operation, should be used in most applications. The supply side of the bias network should also be well bypassed.</p>	
9	GND	Same as pin 1.	

**Package Drawing**

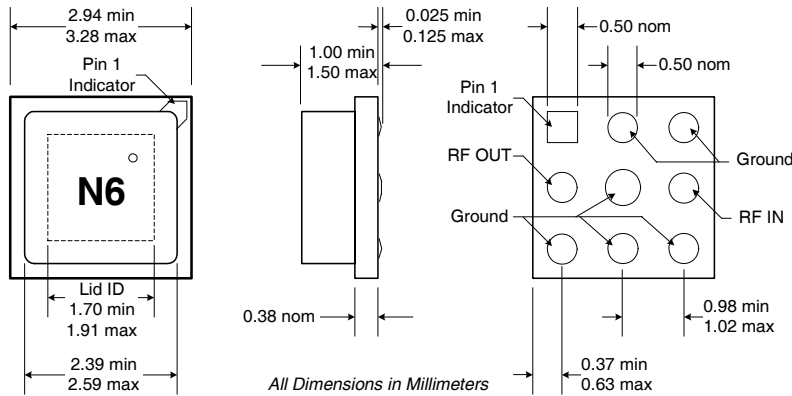

Notes:

1. Solder pads are coplanar to within ±0.025 mm.
2. Lid will be centered relative to frontside metallization with a tolerance of ±0.13 mm.
3. Mark to include two characters and dot to reference pin 1.

## Typical Bias Configuration

Application notes related to biasing circuit, device footprint, and thermal considerations are available on request.

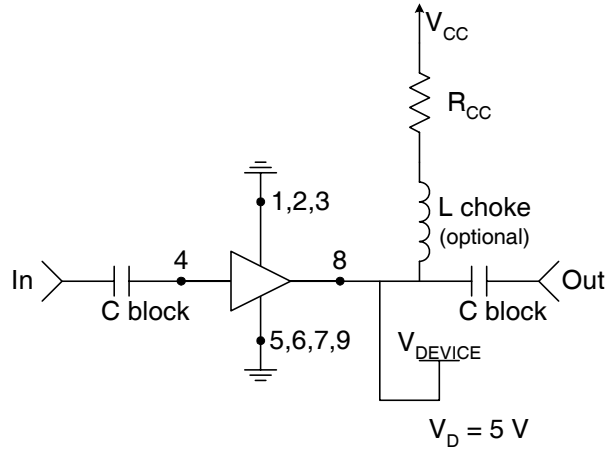

Recommended Bias Resistor Values					
Supply Voltage, $V_{CC}$ (V)	8	10	12	15	20
Bias Resistor, $R_{CC}$ ( $\Omega$ )	60	100	140	200	300

## Application Notes

### Bonding Temperature (Wedge or Ball)

It is recommended that the heater block temperature be set to  $160^{\circ}\text{C} \pm 10^{\circ}\text{C}$ .

**Extended Frequency InGaP Amplifier Designer's Tool Kit  
NBB-X-K1**

This tool kit was created to assist in the design-in of the RFMD NBB- and NLB-series InGaP HBT gain block amplifiers. Each tool kit contains the following.

- 5 each NBB-300, NBB-310 and NBB-400 Ceramic Micro-X Amplifiers
- 5 each NLB-300, NLB-310 and NLB-400 Plastic Micro-X Amplifiers
- 2 Broadband Evaluation Boards and High Frequency SMA Connectors
- Broadband Bias Instructions and Specification Summary Index for ease of operation

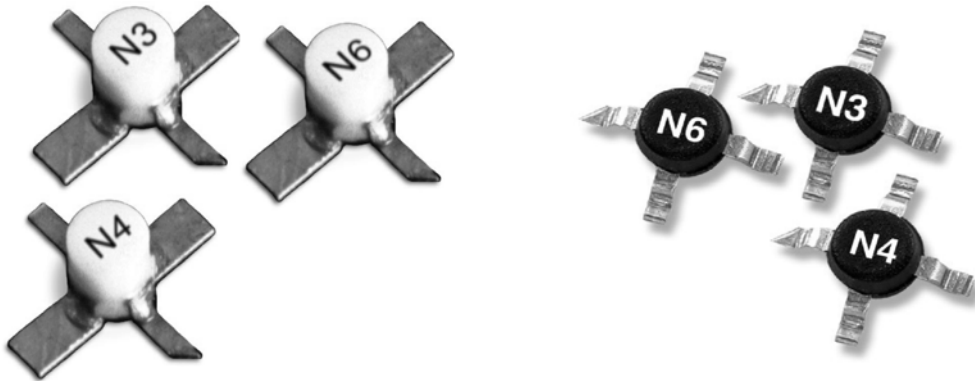

## Tape and Reel Dimensions

All Dimensions in Millimeters

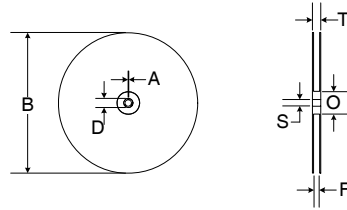

330 mm (13") REEL			Micro-X, MPGA	
	ITEMS	SYMBOL	SIZE (mm)	SIZE (inches)
FLANGE	Diameter	B	330 +0.25/-4.0	13.0 +0.079/-0.158
	Thickness	T	18.4 MAX	0.724 MAX
	Space Between Flange	F	12.4 +2.0	0.488 +0.08
HUB	Outer Diameter	O	102.0 REF	4.0 REF
	Spindle Hole Diameter	S	13.0 +0.5/-0.2	0.512 +0.020/-0.008
	Key Slit Width	A	1.5 MIN	0.059 MIN
	Key Slit Diameter	D	20.2 MIN	0.795 MIN

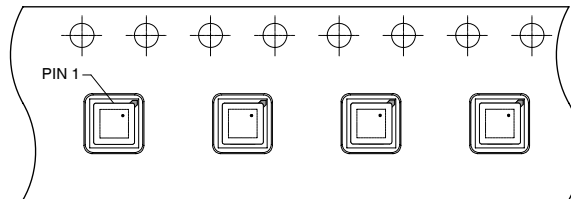

User Direction of Feed

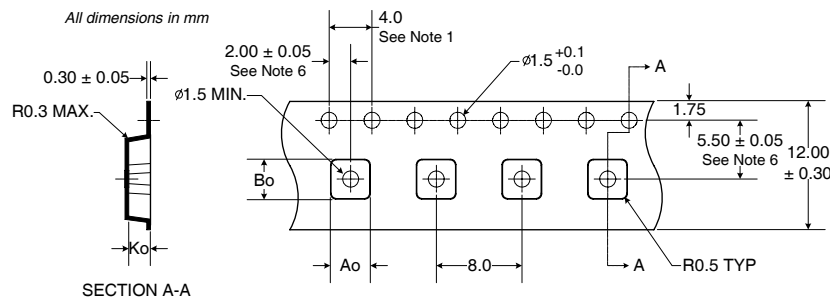

**NOTES:**

1. 10 sprocket hole pitch cumulative tolerance  $\pm 0.2$ .
2. Camber not to exceed 1 mm in 100 mm.
3. Material: PS+C
4.  $A_o$  and  $B_o$  measured on a plane 0.3 mm above the bottom of the pocket.
5.  $K_o$  measured from a plane on the inside bottom of the pocket to the surface of the carrier.
6. Pocket position relative to sprocket hole measured as true position of pocket, not pocket hole.

$A_o = 3.6$  MM  
 $B_o = 3.6$  MM  
 $K_o = 1.7$  MM

P1dB versus Frequency at 25°C

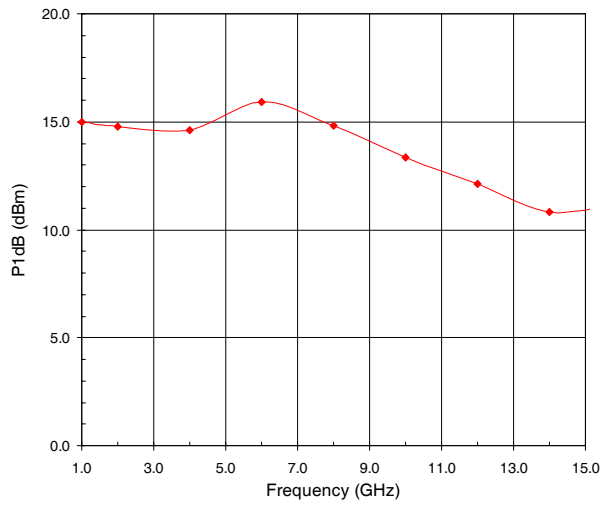

P<sub>OUT</sub>/Gain versus P<sub>IN</sub> at 6 GHz

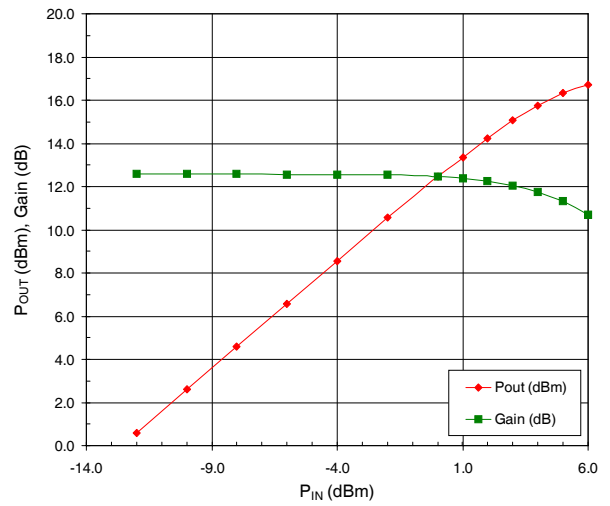

P<sub>OUT</sub>/Gain versus P<sub>IN</sub> at 14 GHz

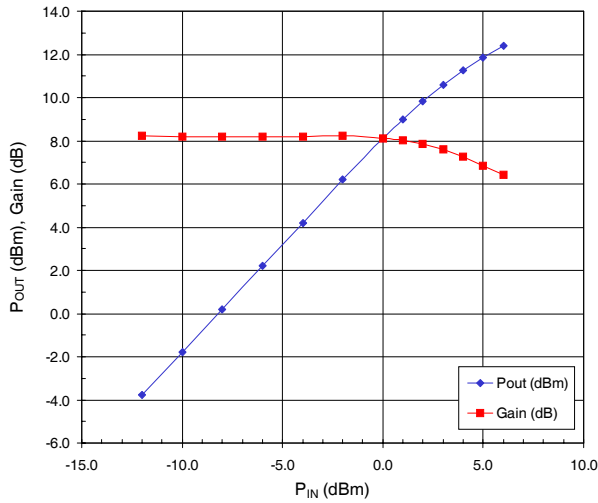

Third Order Intercept versus Frequency at 25°C

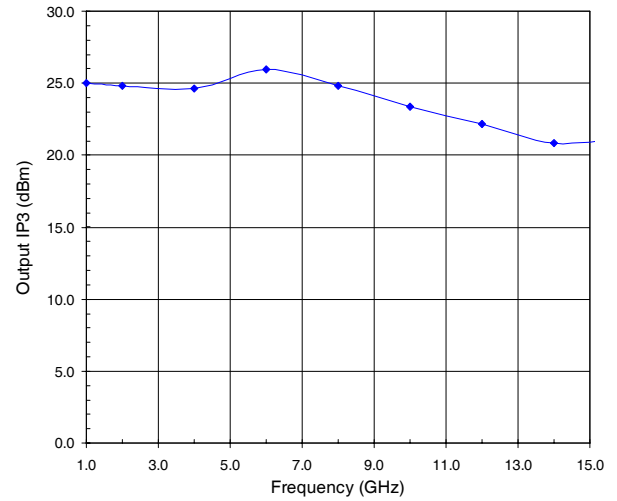

Note: The s-parameter gain results shown below include device performance as well as evaluation board and connector loss variations. The insertion losses of the evaluation board and connectors are as follows:

1GHz to 4GHz=-0.06dB

5GHz to 9GHz=-0.22dB

10GHz to 14GHz=-0.50dB

15GHz to 20GHz=-1.08dB

**S11 versus Frequency at +25°C**

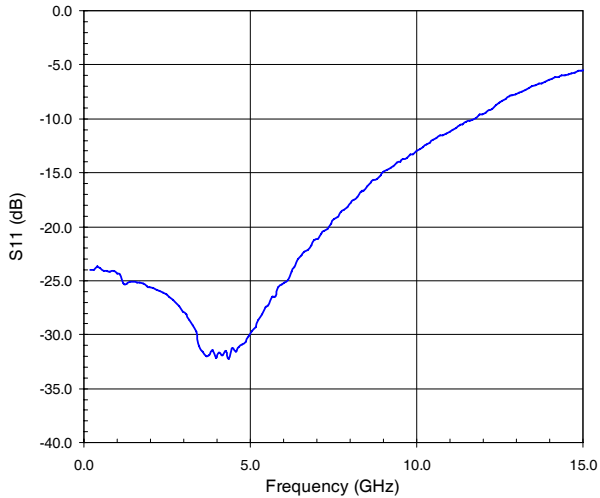

**S12 versus Frequency at +25°C**

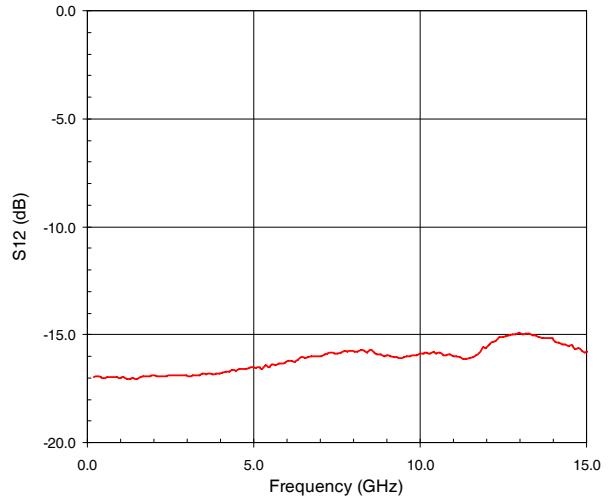

**S21 versus Frequency at +25°C**

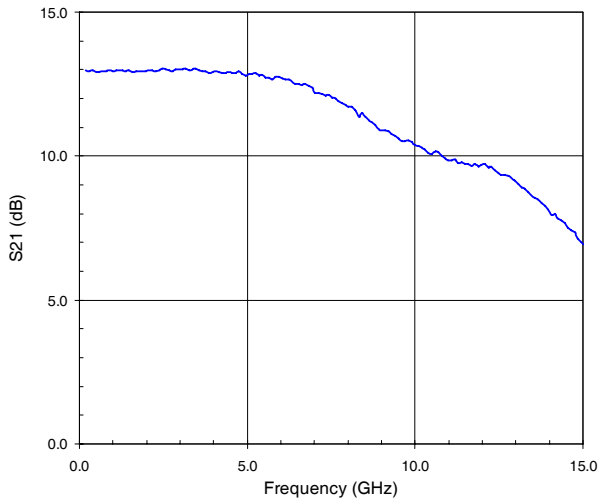

**S22 versus Frequency at +25°C**

