

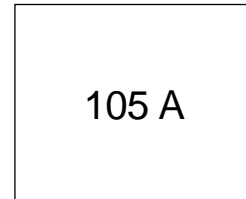

## IRK.F102.. SERIES

**FAST THYRISTOR/ DIODE and  
 THYRISTOR/THYRISTOR**

**INT-A-pak™ Power Modules**



### Features

- Fast turn-off thyristor
- Fast recovery diode
- High surge capability
- Electrically isolated baseplate
- 3000 V<sub>RMS</sub> isolating voltage
- Industrial standard package
- UL E78996 approved 

### Description

These series of INT-A-pak modules are intended for applications such as self-commutated inverters, DC choppers, electronic welders, induction heating and others where fast switching characteristics are required.

### Major Ratings and Characteristics

Parameters	IRK.F102..	Units
$I_{T(AV)}$	105	A
@ $T_C$	90	°C
$I_{T(RMS)}$	233	A
$I_{TSM}$ @ 50Hz	2850	A
@ 60Hz	3000	A
$I^2t$ @ 50Hz	40.8	KA <sup>2</sup> s
@ 60Hz	37.2	KA <sup>2</sup> s
$I^2\sqrt{t}$	408	KA <sup>2</sup> √s
$t_q$	20 and 25	μs
$t_{rr}$	2	μs
$V_{DRM}/V_{RRM}$	upto 1200	V
$T_J$ range	-40 to 125	°C

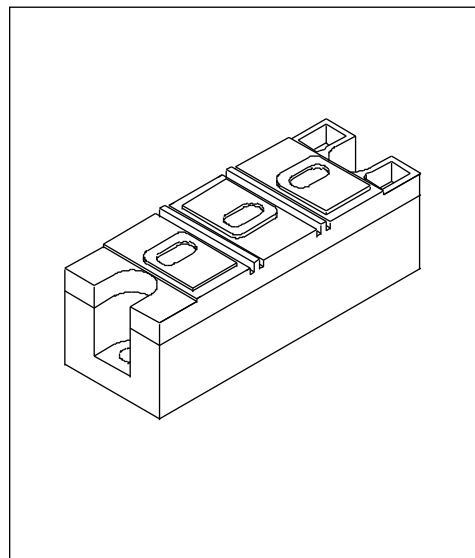

## IRK.F102.. Series

Bulletin I27097 rev. A 09/97

International  
IR Rectifier

### ELECTRICAL SPECIFICATIONS

#### Voltage Ratings

Type number	Voltage Code	$V_{RRM}/V_{DRM}$ maximum repetitive peak reverse voltage V	$V_{RSM}$ , maximum non-repetitive peak rev. voltage V	$I_{RRM}/I_{DRM}$ max. @ $T_J = 125^\circ\text{C}$ mA
IRK.F102.. Series	08	800	800	30
	12	1200	1200	

#### Current Carrying Capacity

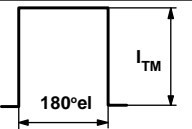
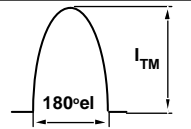
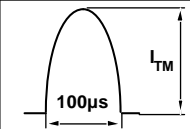
Frequency f							Units
	$I_{TM}$	$I_{TM}$	$I_{TM}$	$I_{TM}$	$I_{TM}$	$I_{TM}$	
50Hz	210	340	320	500	1590	2210	A
400Hz	265	415	395	625	975	1390	A
2500Hz	180	280	320	490	390	570	A
5000Hz	145	230	260	380	260	380	A
10000Hz	110	175	190	275	-	-	A
Recovery voltage Vr	50	50	50	50	50	50	V
Voltage before turn-on Vd	80% $V_{DRM}$		80% $V_{DRM}$		80% $V_{DRM}$		V
Rise of on-state current di/dt	50	50	-	-	-	-	A/ $\mu\text{s}$
Case temperature	90	60	90	60	90	60	$^\circ\text{C}$
Equivalent values for RC circuit	47 $\Omega$ / 0.22 $\mu\text{F}$		47 $\Omega$ / 0.22 $\mu\text{F}$		47 $\Omega$ / 0.22 $\mu\text{F}$		

#### On-state Conduction

Parameter	IRK.F102..	Units	Conditions
$I_{T(AV)}$ Maximum average on-state current @ Case temperature	105	A	180° conduction, half sine wave
	90	$^\circ\text{C}$	
$I_{T(RMS)}$ Maximum RMS current	233	A	$T_C = 90^\circ\text{C}$ , as AC switch
$I_{TSM}$ Maximum peak, one-cycle, non-repetitive surge current	2850	A	t = 10ms No voltage reappplied
	3000		t = 8.3ms 100% $V_{RRM}$ reappplied
	2400		t = 10ms 100% $V_{RRM}$ reappplied
	2500		t = 8.3ms 100% $V_{RRM}$ reappplied
$I^2t$ Maximum $I^2t$ for fusing	40.8	$\text{KA}^2\text{s}$	t = 10ms No voltage reappplied
	37.2		t = 8.3ms 100% $V_{RRM}$ reappplied
	28.8		t = 10ms 100% $V_{RRM}$ reappplied
	26.3		t = 8.3ms 100% $V_{RRM}$ reappplied
$I^2\sqrt{t}$ Maximum $I^2\sqrt{t}$ for fusing	408	$\text{KA}^2\sqrt{\text{s}}$	t = 0 to 10ms, no voltage reappplied
$V_{T(TO)1}$ Low level value of threshold voltage	1.12	V	$(16.7\% \times \pi \times I_{T(AV)} < I < \pi \times I_{T(AV)})$ , $T_J = T_J \text{ max.}$
$V_{T(TO)2}$ High level value of threshold voltage	1.28		$(I > \pi \times I_{T(AV)})$ , $T_J = T_J \text{ max.}$
$r_{t1}$ Low level value of on-state slope resistance	2.43	mW	$(16.7\% \times \pi \times I_{T(AV)} < I < \pi \times I_{T(AV)})$ , $T_J = T_J \text{ max.}$
$r_{t2}$ High level value of on-state slope resistance	2.00		$(I > \pi \times I_{T(AV)})$ , $T_J = T_J \text{ max.}$
$V_{TM}$ Maximum on-state voltage drop	1.97	V	$I_{pk} = 350\text{A}$ , $T_J = T_J \text{ max.}$ , $t_p = 10\text{ms}$ sine pulse
$I_H$ Maximum holding current	600	mA	$T_J = 25^\circ\text{C}$ , $I_T > 30\text{A}$
$I_L$ Typical latching current	1000	mA	$T_J = 25^\circ\text{C}$ , $V_A = 12\text{V}$ , $R_a = 6\Omega$ , $I_g = 1\text{A}$

**Switching**

Parameter	IRK.F102..	Units	Conditions
di/dt Maximum non-repetitive rate of rise	800	A/μs	Gate drive 20V, 20Ω, tr ≤ 1ms, V <sub>D</sub> = 80% V <sub>DRM</sub> T <sub>J</sub> = 25°C
t <sub>rr</sub> Maximum recovery time	2	μs	I <sub>TM</sub> = 350A, di/dt = -25A/μs, V <sub>R</sub> = 50V, T <sub>J</sub> = 25°C
t <sub>q</sub> Maximum turn-off time	K 20	J μs	I <sub>TM</sub> = 350A, T <sub>J</sub> = 125°C, di/dt = -25A/μs, V <sub>R</sub> = 50V, dv/dt = 400V/μs linear to 80% V <sub>DRM</sub>

**Blocking**

Parameter	IRK.F102..	Units	Conditions
dv/dt Maximum critical rate of rise of off-state voltage	1000	V/μs	T <sub>J</sub> = 125°C., exponential to = 67% V <sub>DRM</sub>
V <sub>INS</sub> RMS isolation voltage	3000	V	50 Hz, circuit to base, T <sub>J</sub> = 25°C, t = 1 s
I <sub>RRM</sub> Maximum peak reverse and off-state leakage current I <sub>DRM</sub>	30	mA	T <sub>J</sub> = 125°C, rated V <sub>DRM</sub> /V <sub>RRM</sub> applied

**Triggering**

Parameter	IRK.F102..	Units	Conditions
P <sub>GM</sub> Maximum peak gate power	40	W	f = 50 Hz, d% = 50
P <sub>G(AV)</sub> Maximum peak average gate power	2	W	T <sub>J</sub> = 125°C, f = 50Hz, d% = 50
I <sub>GM</sub> Maximum peak positive gate current	5	A	T <sub>J</sub> = 125°C, t <sub>p</sub> ≤ 5ms
-V <sub>GM</sub> Maximum peak negative gate voltage	5	V	
I <sub>GT</sub> Max. DC gate current required to trigger	200	mA	T <sub>J</sub> = 25°C, V <sub>ak</sub> 12V, Ra = 6
V <sub>GT</sub> DC gate voltage required to trigger	3	V	
I <sub>GD</sub> DC gate current not to trigger	20	mA	T <sub>J</sub> = 125°C, rated V <sub>DRM</sub> applied
V <sub>GD</sub> DC gate voltage not to trigger	0.25	V	

**Thermal and Mechanical Specifications**

Parameter	IRK.F102..	Units	Conditions
T <sub>J</sub> Max. junction operating temperature range	- 40 to 125	°C	
T <sub>stg</sub> Max. storage temperature range	- 40 to 150		
R <sub>thJC</sub> Max. thermal resistance, junction to case	0.25	K/W	Per junction, DC operation
R <sub>thC-hs</sub> Max. thermal resistance, case to heatsink	0.035	K/W	Mounting surface flat and greased Per module
T Mounting torque ± 10%	IAP to heatsink	4 - 6 (35 - 53)	A mounting compound is recommended. The torque should be rechecked after a period of 3 hours to allow for the spread of the compound. Use of cable lugs is not recommended, busbars should be used and restrained during tightening. Threads must be lubricated with a compound
	busbar to IAP	4 - 6 (35 - 53)	
wt Approximate weight	500 (17.8)	Nm (lb*in)	

## IRK.F102.. Series

Bulletin I27097 rev. A 09/97

International  
**IR** Rectifier

### $\Delta R_{thJC}$ Conduction

(The following table shows the increment of thermal resistance  $R_{thJC}$  when devices operate at different conduction angles than DC)

Conduction angle	Sinusoidal conduction	Rectangular conduction	Units	Conditions
180°	0.016	0.011	K/W	$T_J = 125^\circ\text{C}$
120°	0.019	0.020		
90°	0.024	0.026		
60°	0.035	0.037		
30°	0.060	0.060		

### Ordering Information Table

Device Code									
IRK	T	F	10	2	-	08	H	L	N
①	②	③	④	⑤		⑥	⑦	⑧	⑧
<b>1</b>	- Module type								
<b>2</b>	- Circuit configuration								
<b>3</b>	- Fast SCR								
<b>4</b>	- Current rating: $I_{T(AV)} \times 10$ rounded								
<b>5</b>	- 1 = option with spacers and longer terminal screws 2 = option with standard terminal screws								
<b>6</b>	- Voltage code: Code $\times 100 = V_{RRM}$ (See Voltage Ratings Table)								
<b>7</b>	- dv/dt code: $H \leq 400\text{V}/\mu\text{s}$								
<b>8</b>	- $t_q$ code: $K \leq 20\mu\text{s}$ $J \leq 25\mu\text{s}$								
<b>9</b>	- None = Standard devices N = Aluminum nitride substrate								

**NOTE: To order the Optional Hardware see Bulletin I27900**

Outline Table

(SEE TABLE) A A

U  
D  
C  
m

94(3.70)  
80(3.15)  
7  
(0.27)

34  
(1.34)

3 Screws M6 x 1

2 HOLES  $\varnothing$  6.5

8(0.32)

- All dimensions in millimeters (inches)
- Dimensions are nominal
- Full engineering drawings are available on request
- UL identification number for gate and cathode wire: UL 1385
- UL identification number for package: UL 94V0

For all types	A	B	C	D	E
IRK...1	25 (0.98)	----	----	41 (1.61)	47 (1.85)
IRK...2	23 (0.91)	30 (1.18)	36 (1.42)	----	----

IRKTF.. IRKHF.. IRKLF.. IRKUF.. IRKV.. IRKVF.. IRKFF.. IRKNF..

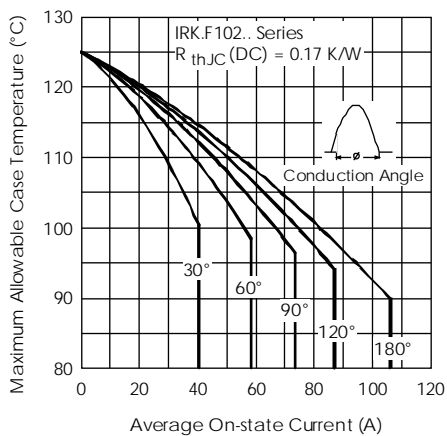

Fig. 1 - Current Ratings Characteristics

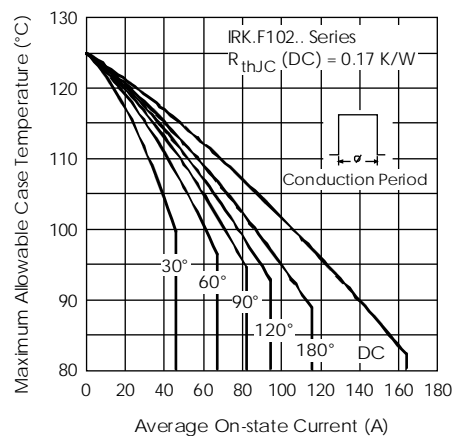

Fig. 2 - Current Ratings Characteristics

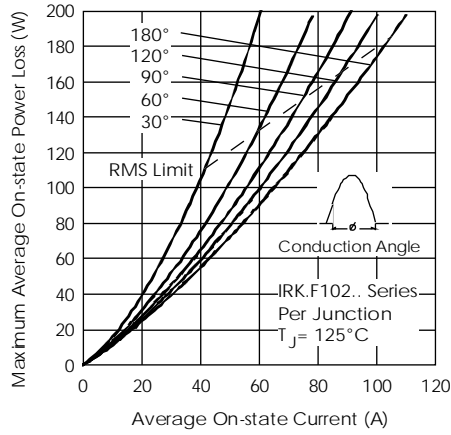

Fig. 3 - On-state Power Loss Characteristics

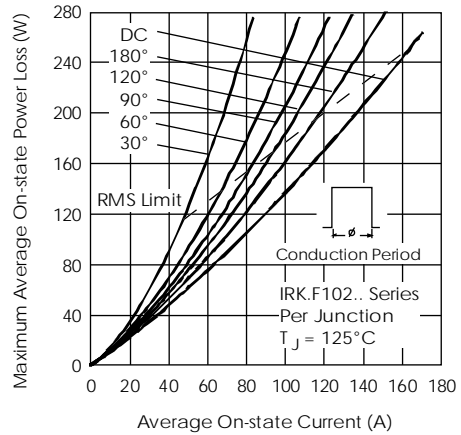

Fig. 4 - On-state Power Loss Characteristics

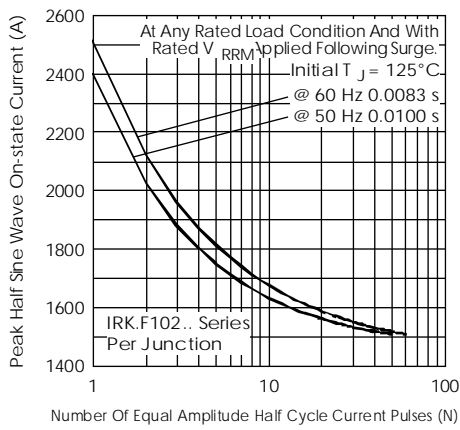

Fig. 5 - Maximum Non-Repetitive Surge Current

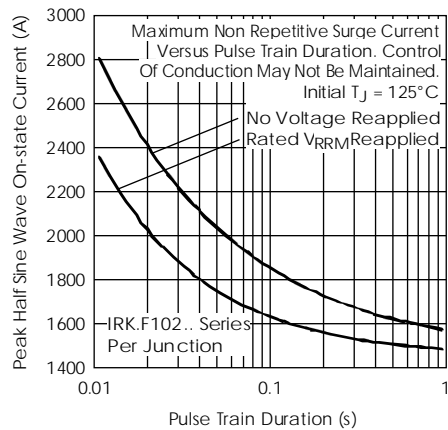

Fig. 6 - Maximum Non-Repetitive Surge Current

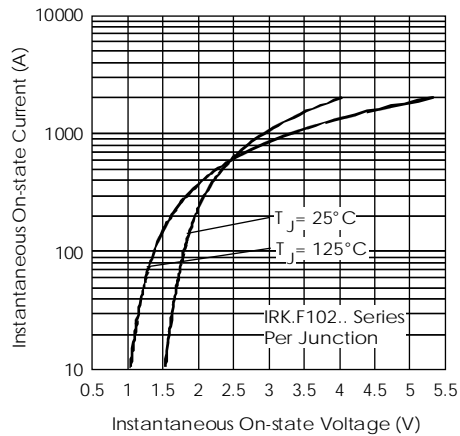

Fig. 7 - On-state Voltage Drop Characteristics

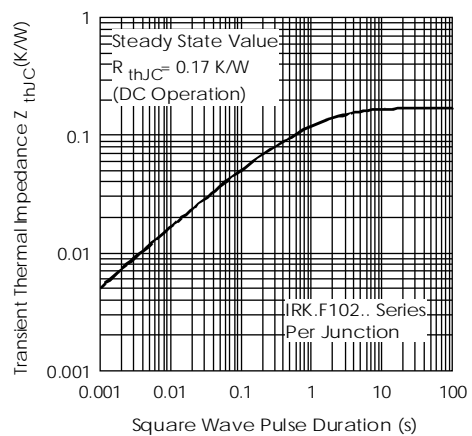

Fig. 8 - Thermal Impedance  $Z_{thJC}$  Characteristic

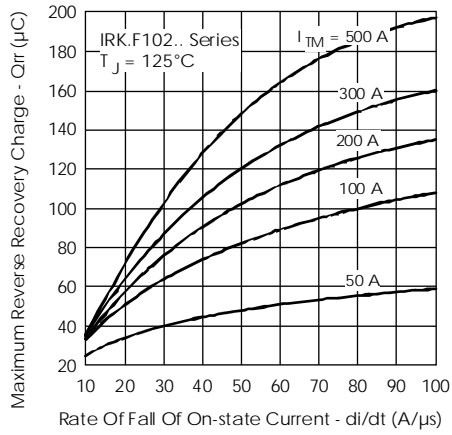

Fig. 9 - Reverse Recovery Charge Characteristics

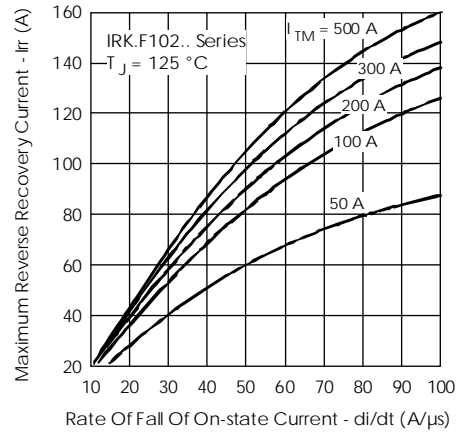

Fig. 10 - Reverse Recovery Current Characteristics

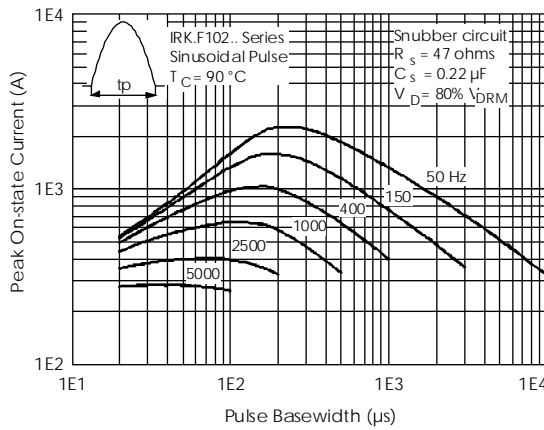

Fig. 11 - Frequency Characteristics

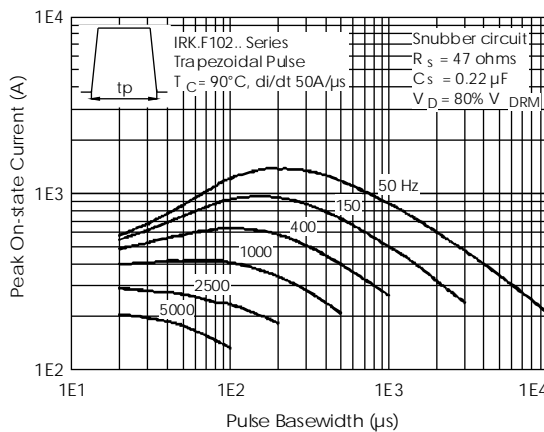
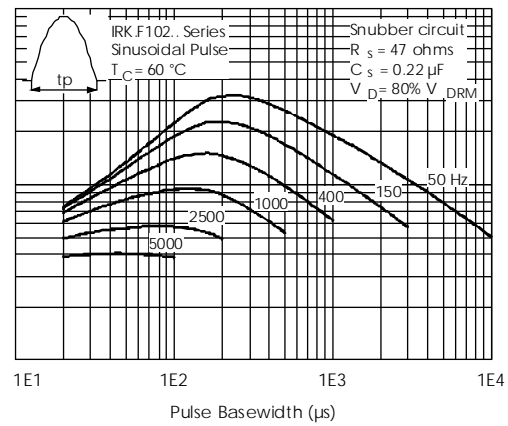
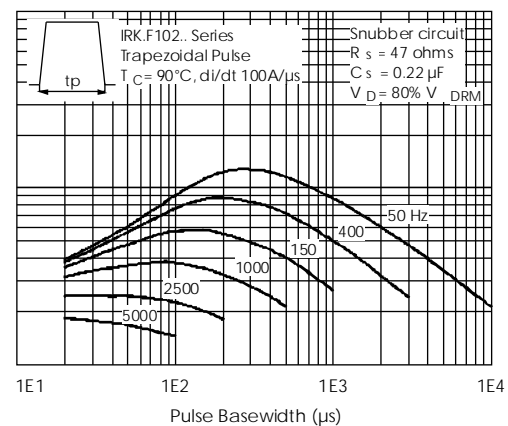

Fig. 12 - Frequency Characteristics



# IRK.F102.. Series

Bulletin I27097 rev. A 09/97

International  
**IR** Rectifier

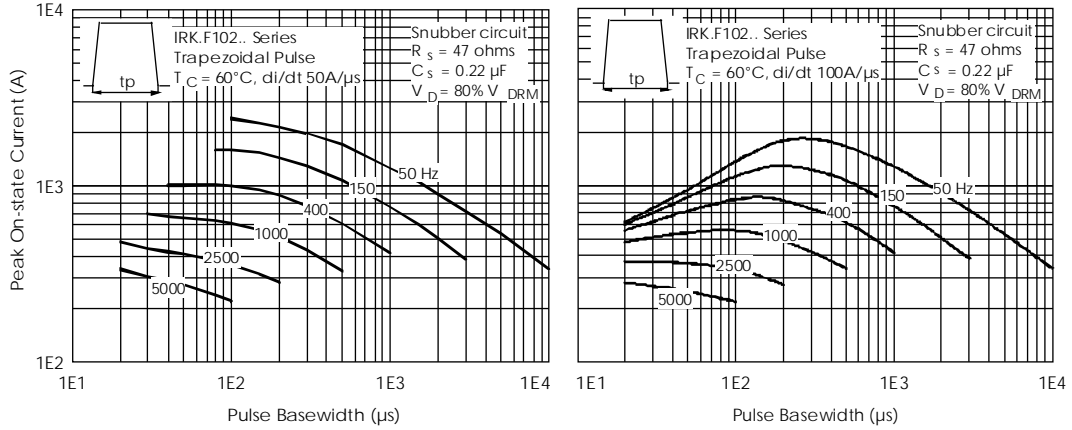

Fig. 13 - Frequency Characteristics

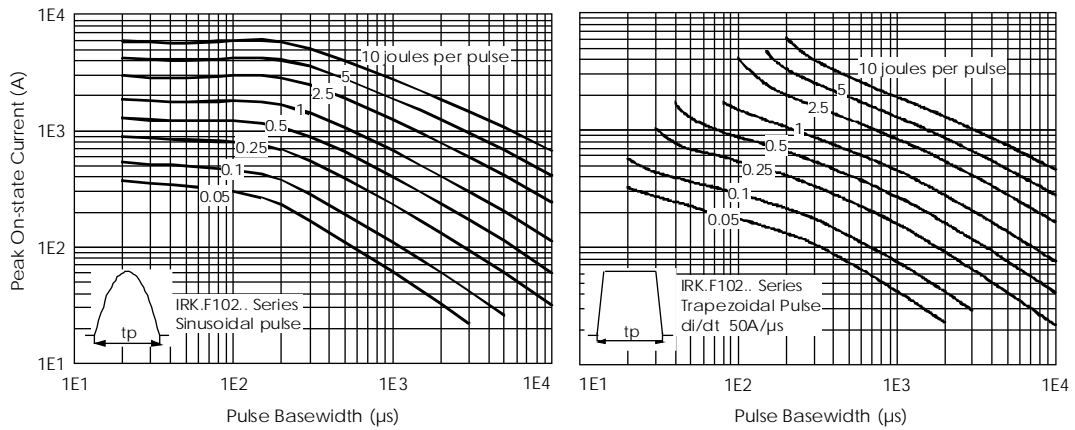

Fig. 14 - Maximum On-state Energy Power Loss Characteristics

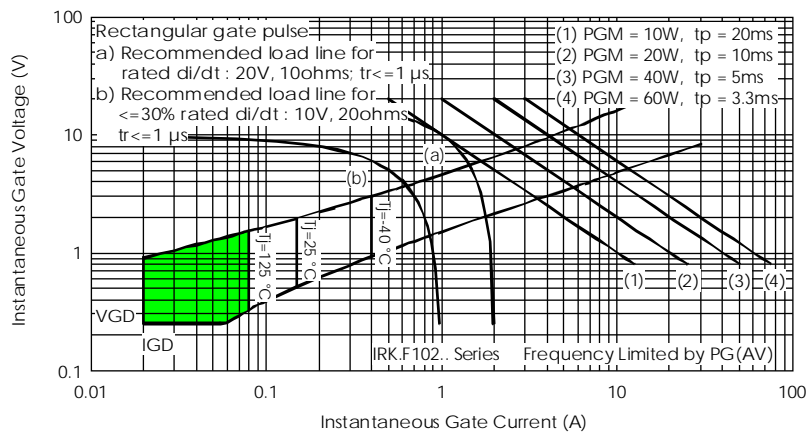

Fig. 15 - Gate Characteristics