



Aluminum electrolytic capacitors

Axial-lead and soldering star capacitors

Series/Type: B41692, B41792

Date: December 2006

www.DataSheet4U.com

© EPCOS AG 2007. Reproduction, publication and dissemination of this publication, enclosures hereto and the information contained therein without EPCOS' prior express consent is prohibited.

Applications

- Compact design for automotive applications up to 150 °C

Features

- Up to 150 °C operating temperature at reduced voltage applied
- Long useful life, 2000 h at up to 140 °C
- Very high ripple current capability
- Compact design
- High vibration resistance
- Shelf life up to 15 years at storage temperatures up to 40 °C.
To ensure solderability, the capacitors should be built into the application within one year of delivery. After a total of two years' storage, the operating voltage must be applied for one hour to ensure the specified leakage current.

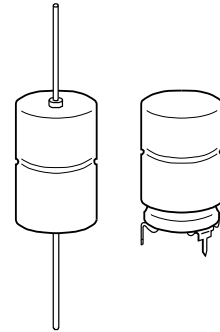

Construction

- Charge/discharge-proof, polar
- Aluminum case with insulating sleeve
- Negative pole connected to case

Terminals

- Axial leads, welded to ensure perfect electrical contact
- Also available with soldering stars

Taping and packing

- Axial-lead capacitors will be delivered in pallet package.
Capacitors with $d \times l \leq 16 \times 30$ mm are also available taped on reel.
- Soldering star capacitors are packed in cardboard.

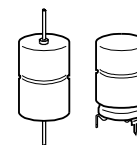
Specifications and characteristics in brief

Rated voltage V_R	25 ... 63 V DC						
Surge voltage V_S	$1.15 \cdot V_R$						
Rated capacitance C_R	220 ... 6800 μF						
Capacitance tolerance	$-10/+30\% \triangle Q$						
Leakage current I_{leak} (5 min, 20 °C)	$I_{\text{leak}} \leq 0.006 \mu\text{A} \cdot \left(\frac{C_R}{\mu\text{F}} \cdot \frac{V_R}{V} \right) + 4 \mu\text{A}$						
Self-inductance ESL ¹⁾	Diameter d (mm)		12	14	16	18	20/21
	Terminals	Length l (mm)	Approx. ESL (nH)				
	axial	25	–	22	26	–	–
		29	–	–	–	–	38
		30	21	24	29	34	–
		39	–	–	33	38	45
		49	–	–	–	–	50
	soldering star	25	–	6	7	–	–
		30	6	7	8	10	–
39		–	–	9	11	–	
Useful life 150 °C, $V_{\text{op}}, 0.5 \cdot I_{\text{AC,R}}^{*)}$ 140 °C, $V_R, 0.6 \cdot I_{\text{AC,R}}$ 125 °C, $V_R, I_{\text{AC,R}}$ 85 °C, $V_R, I_{\text{AC,max}}$ 40 °C, $V_R, 2 \cdot I_{\text{AC,R}}$ ^{*)} V_{op} : see useful life graph	> 2000 h > 2000 h > 5000 h > 15000 h > 500000 h			Requirements: $\Delta C/C \leq \pm 30\%$ of initial value ESR ≤ 3 times initial specified limit $I_{\text{leak}} \leq$ initial specified limit			
Voltage endurance test 125 °C, V_R	2000 h			Post test requirements: $\Delta C/C \leq \pm 10\%$ of initial value ESR $\leq 1.3\%$ initial specified limit $I_{\text{leak}} \leq$ initial specified limit			
Vibration resistance test	To IEC 60068-2-6, test Fc: Displacement amplitude 1.5 mm, at 10 Hz ... 2 kHz, acceleration max. 20 g, duration 3×2 h. Capacitor mounted by its wire leads at a distance of (6 ± 1) mm from the case and additionally clamped by the case.						
IEC climatic category	To IEC 60068-1: 55/125/56 (-55 °C/ $+125$ °C/56 days damp heat test)						
Detail specification	Similar to CECC 30301-802						
Sectional specification	IEC 60384-4						

1) If optimum circuit design is used, the values are lower by 30%.

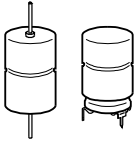

B41692, B41792

Long useful life, compact – up to 140 °C

Axial-lead capacitors

Dimensional drawing

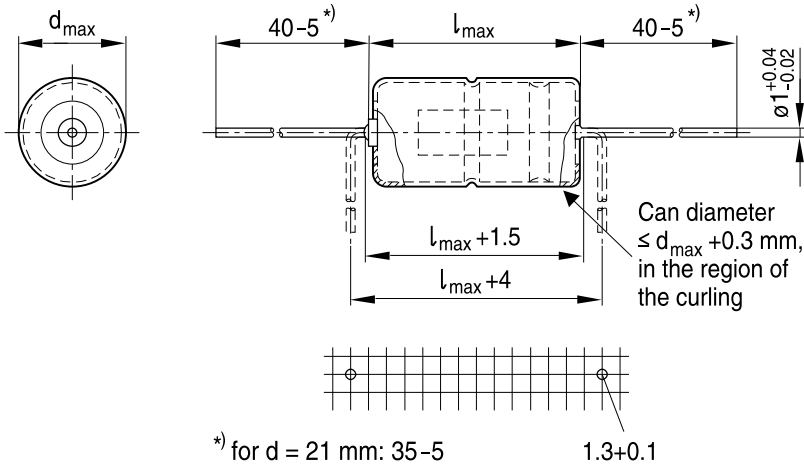

KAL0524-S-E

Dimensions, weights and packing units

d × l mm	d _{max} × l _{max} mm	Approx. weight g	Packing units (pcs.)	
			Pallet	Reel
12 × 30	12.5 × 30.5	5.1	288	450
14 × 25	14.5 × 25.5	5.7	200	350
14 × 30	14.5 × 30.5	6.8	200	350
16 × 30	16.5 × 30.5	8.9	180	250
16 × 39	16.5 × 40	11.7	180	–
18 × 30	18.5 × 30.5	11.1	160	–
18 × 39	18.5 × 40	14.7	160	–
20 × 29	20.5 × 29.5	13.5	140	–
21 × 39	21.5 × 40	20.0	140	–
21 × 49	21.5 × 50	25.0	110	–

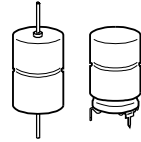

Soldering star capacitors

Dimensional drawing

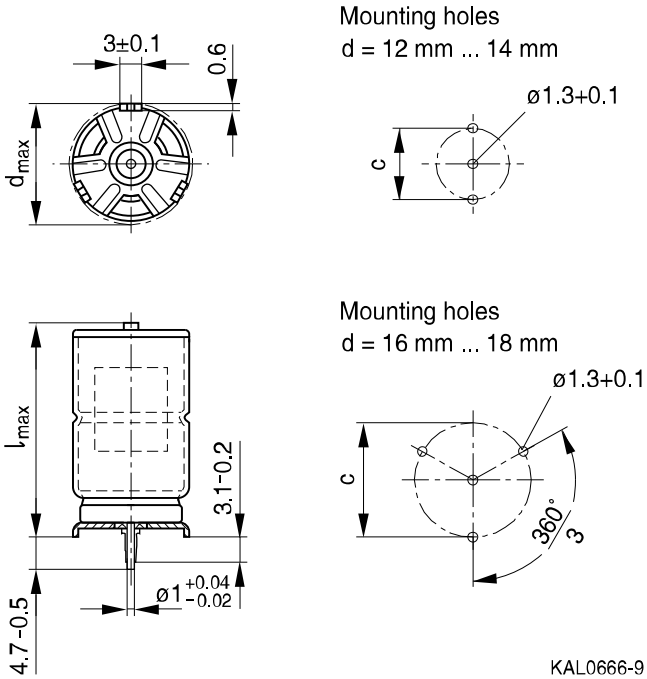

Dimensions, weights and packing units

d × l mm	d _{max} × l _{max} mm	c ±0.1 mm	Approx. weight g	Packing units pcs.
12 × 30	13.5 × 32	12.5	5.4	480
14 × 25	15.5 × 27	14.5	6.1	480
14 × 30	15.5 × 32	14.5	7.2	480
16 × 30	17.5 × 32	16.5	9.4	300
16 × 39	17.5 × 41.5	16.5	12.2	200
18 × 30	19.5 × 32	18.5	11.8	300
18 × 39	19.5 × 41.5	18.5	15.4	200

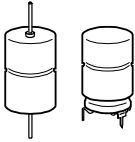

B41692, B41792

Long useful life, compact – up to 140 °C

Overview of available types

V_R (V DC)	25	40	63
	Case dimensions $d \times l$ (mm)		
C_R (μF)			
220			12 × 30
330			14 × 30
470		12 × 30	16 × 30
680	12 × 30	14 × 30	16 × 39 18 × 30
1000	14 × 25	16 × 30	18 × 39
1100			20 × 29
1500	14 × 30	16 × 39 18 × 30	
1800			21 × 39
2200	16 × 39 18 × 30	18 × 39 20 × 29	21 × 49
3300	18 × 39 20 × 29	21 × 39	
4400		21 × 49	
5000	21 × 39		
6800	21 × 49		

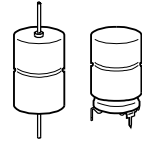
Case dimensions and ordering codes

V_R	C_R 100 Hz 20 °C μF	Case dimensions $d \times l$ mm	Ordering code Axial pallet	Ordering code Axial reel	Ordering code Soldering star
25	680	12 × 30	B41692A5687Q007	B41692A5687Q009	B41792A5687Q000
	1000	14 × 25	B41692A5108Q007	B41692A5108Q009	B41792A5108Q000
	1500	14 × 30	B41692A5158Q007	B41692A5158Q009	B41792A5158Q000
	2200	16 × 39	B41692A5228Q007		B41792A5228Q000
	2200 ▽	18 × 30	B41692B5228Q007		B41792B5228Q000
	3300	18 × 39	B41692A5338Q007		B41792A5338Q000
	3300 ▽	20 × 29	B41692B5338Q007		
	5000 6800	21 × 39 21 × 49	B41692A5508Q007 B41692A5688Q007		
40	470	12 × 30	B41692A7477Q007	B41692A7477Q009	B41792A7477Q000
	680	14 × 30	B41692A7687Q007	B41692A7687Q009	B41792A7687Q000
	1000	16 × 30	B41692A7108Q007	B41692A7108Q009	B41792A7108Q000
	1500	16 × 39	B41692A7158Q007		B41792A7158Q000
	1500 ▽	18 × 30	B41692B7158Q007		B41792B7158Q000
	2200	18 × 39	B41692A7228Q007		B41792A7228Q000
	2200 ▽	20 × 29	B41692B7228Q007		
	3300 4400	21 × 39 21 × 49	B41692A7338Q007 B41692A7448Q007		
63	220	12 × 30	B41692A8227Q007	B41692A8227Q009	B41792A8227Q000
	330	14 × 30	B41692A8337Q007	B41692A8337Q009	B41792A8337Q000
	470	16 × 30	B41692A8477Q007	B41692A8477Q009	B41792A8477Q000
	680	16 × 39	B41692A8687Q007		B41792A8687Q000
	680 ▽	18 × 30	B41692B8687Q007		B41792B8687Q000
	1000	18 × 39	B41692A8108Q007		B41792A8108Q000
	1100	20 × 29	B41692A8118Q007		
	1800	21 × 39	B41692A8188Q007		
	2200	21 × 49	B41692A8228Q007		

▽ Variant with different case dimensions

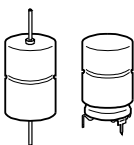
B41692, B41792
Long useful life, compact – up to 140 °C
Technical data

C_R 100 Hz 20 °C μF	ESR_{typ} 100 Hz 20 °C mΩ	ESR_{max} 100 Hz 20 °C mΩ	ESR_{max} 100 Hz -40 °C mΩ	ESR_{max} 10 kHz 20 °C mΩ	Z_{max} 100 kHz 20 °C mΩ	$I_{AC,max}$ 10 kHz 85 °C A	$I_{AC,max}$ 10 kHz 105 °C A	$I_{AC,max}$ 10 kHz 125 °C A	$I_{AC,R}$ 10 kHz 125 °C A	$I_{AC,max}$ 10 kHz 140 °C A
$V_R = 25$ V DC										
680	150	250	1600	165	155	4.5	3.8	2.85	1.95	1.25
1000	100	170	1200	120	112	4.8	4.1	3.1	2.1	1.4
1500	70	120	800	82	77	6.2	5.3	4.0	2.75	1.8
2200	50	82	550	55	50	9.2	7.9	5.9	4.05	2.6
2200 ▽	48	79	550	52	48	9.1	7.8	5.8	4.0	2.6
3300	32	53	360	35	33	12.7	10.8	8.1	5.5	3.6
3300 ▽	33	55	360	38	36	10.6	9.1	6.8	4.6	3.0
5000	22	37	240	27	27	15.0	12.9	9.6	6.6	4.3
6800	17	28	180	20	20	19.0	16.3	12.1	8.3	5.4
$V_R = 40$ V DC										
470	145	240	1400	135	128	4.9	4.2	3.1	2.15	1.4
680	105	170	1000	95	90	6.0	5.1	3.8	2.6	1.7
1000	73	120	660	70	67	6.9	5.9	4.4	3.0	2.0
1500	49	80	450	50	48	9.6	8.2	6.1	4.2	2.7
1500 ▽	46	77	450	45	43	9.7	8.3	6.1	4.2	2.7
2200	32	53	300	30	29	13.3	11.4	8.5	5.8	3.8
2200 ▽	34	55	300	33	32	10.9	9.3	6.9	4.8	3.1
3300	23	39	200	23	23	15.4	13.1	9.8	6.7	4.4
4400	18	30	160	18	18	19.4	16.6	12.3	8.5	5.5
$V_R = 63$ V DC										
220	210	350	1600	145	138	4.7	4.0	3.0	2.05	1.35
330	140	240	1100	100	95	5.9	5.0	3.7	2.55	1.7
470	105	170	750	75	72	6.8	5.8	4.3	3.0	2.0
680	71	120	500	55	53	9.4	8.0	6.0	4.1	2.7
680 ▽	69	114	500	50	48	9.4	8.0	6.0	4.1	2.7
1000	50	78	350	35	34	13.0	11.1	8.2	5.7	3.7
1100	48	75	330	36	35	10.9	9.3	6.9	4.8	3.1
1800	30	47	220	23	23	15.5	13.2	9.8	6.7	4.4
2200	25	38	175	19	19	19.3	16.5	12.3	8.5	5.5

▽ Variant with different case dimensions

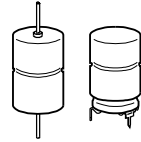

Useful life

depending on ambient temperature T_A under ripple current operating conditions at $V_R^{1)}$

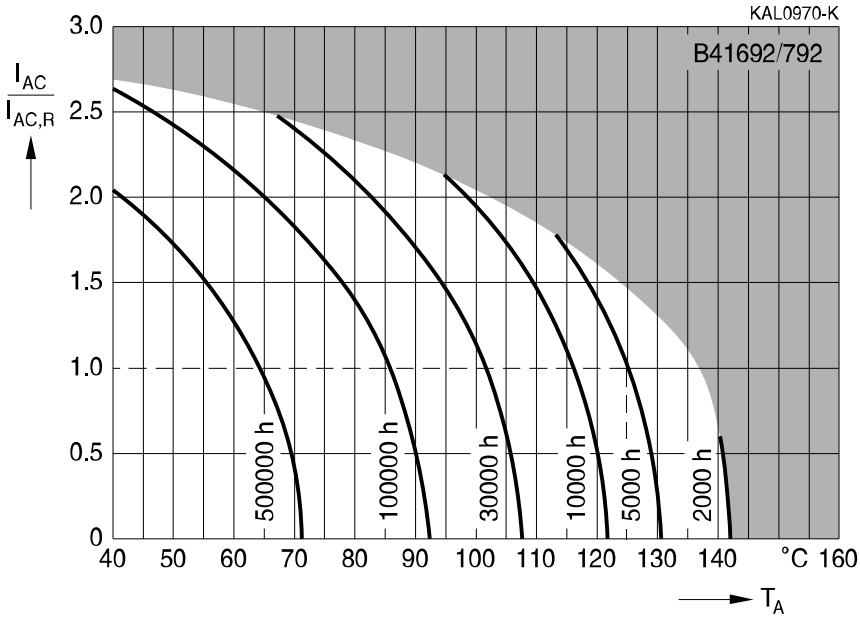

Useful life

depending on case temperature T_C under ripple current operating conditions at $V_R^{1)}$

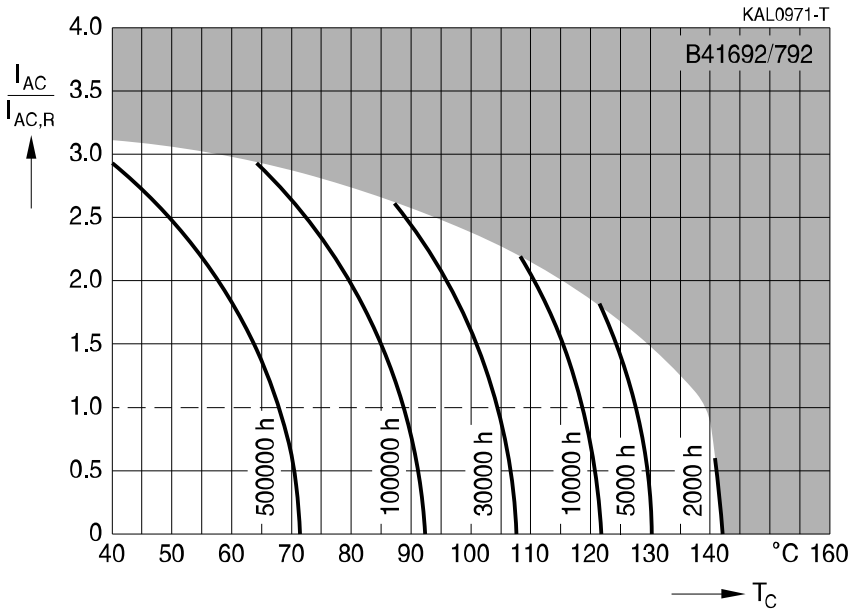

1) Refer to chapter "General technical information, 5.3 Calculation of useful life" for an explanation on how to interpret the useful life graphs.

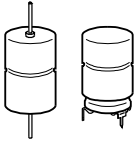

B41692, B41792

Long useful life, compact – up to 140 °C

Useful life

depending on ambient temperature T_A under ripple current operating conditions at $V_{op}^{2)}$

$V_R = 25 \text{ V}: V_{op} \leq 20 \text{ V};$

$V_R = 40 \text{ V}: V_{op} \leq 35 \text{ V};$

$V_R = 63 \text{ V}: V_{op} \leq 55 \text{ V}$

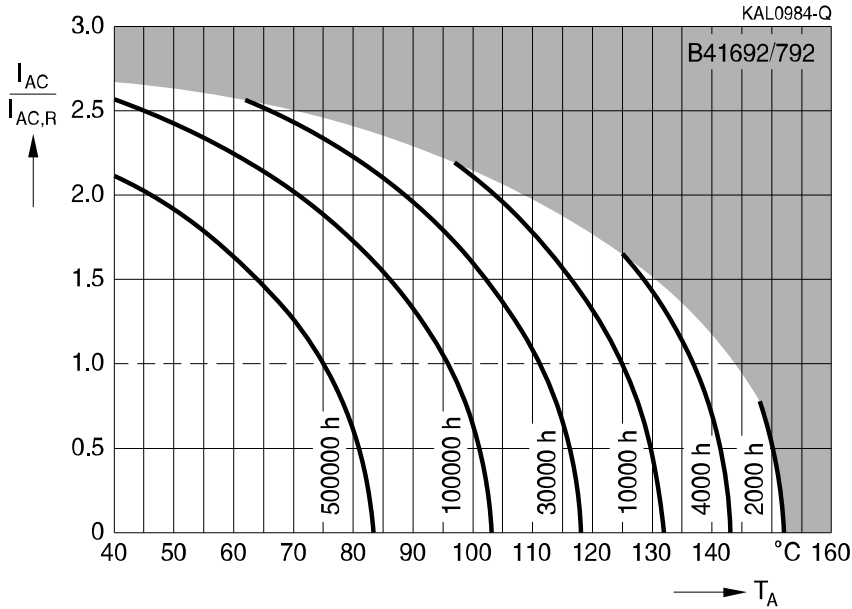

Useful life

depending on case temperature T_C under ripple current operating conditions at $V_{op}^{2)}$

$V_R = 25 \text{ V}: V_{op} \leq 20 \text{ V};$

$V_R = 40 \text{ V}: V_{op} \leq 35 \text{ V};$

$V_R = 63 \text{ V}: V_{op} \leq 55 \text{ V}$

2) Refer to chapter "General technical information, 5.3 Calculation of useful life" for an explanation on how to interpret the useful life graphs.

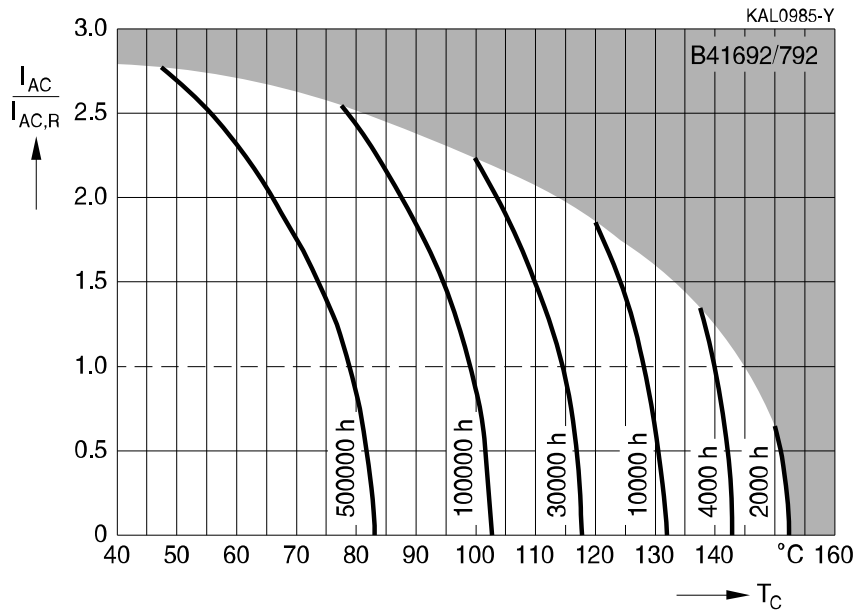
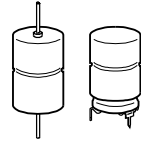

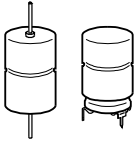

B41692, B41792

Long useful life, compact – up to 140 °C

Frequency factor of permissible ripple current I_{AC} versus frequency f

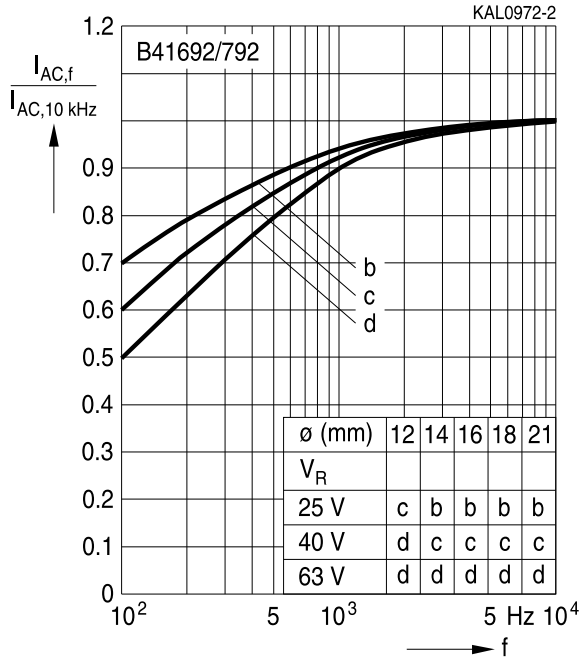

Frequency characteristics of ESR
Typical behavior

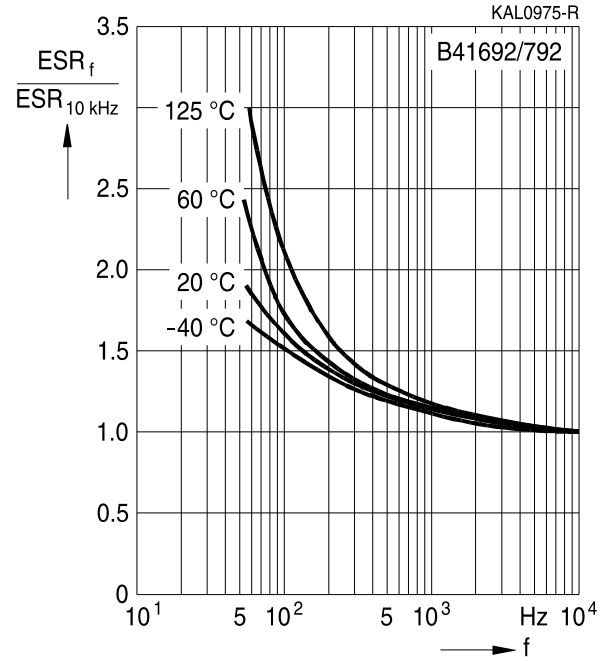

Equivalent series resistance ESR versus frequency f

Typical behavior for 2200 μ F/25 V

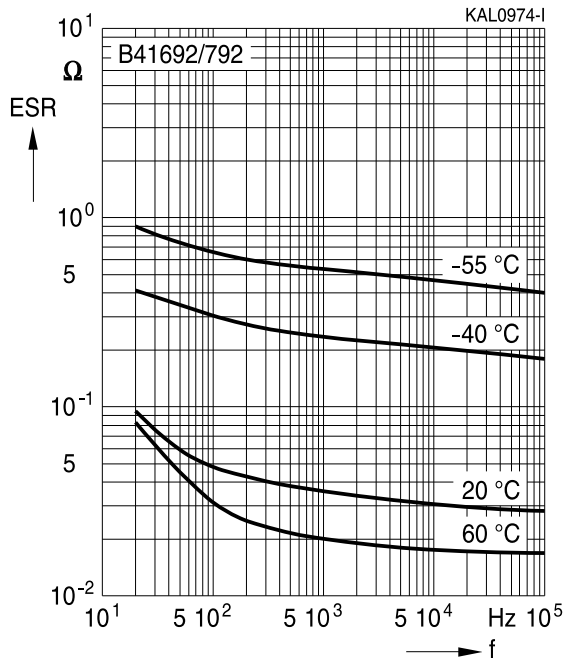

Impedance Z versus frequency f

Typical behavior for 2200 μ F/25 V

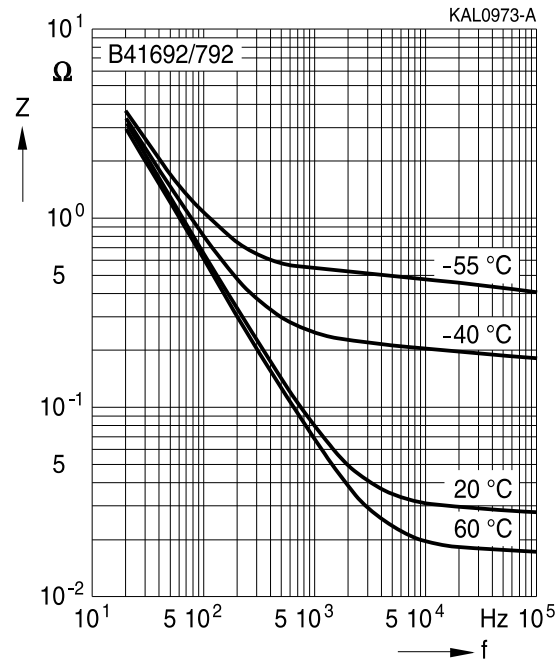

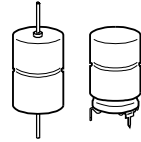

Cautions and warnings

Personal safety

The electrolytes used by EPCOS have not only been optimized with a view to the intended application, but also with regard to health and environmental compatibility. They do not contain any solvents that are detrimental to health, e.g. dimethyl formamide (DMF) or dimethyl acetamide (DMAC).

Furthermore, part of the high-voltage electrolytes used by EPCOS are self-extinguishing. They contain flame-retarding substances which will quickly extinguish any flame that may have been ignited.

As far as possible, EPCOS does not use any dangerous chemicals or compounds to produce operating electrolytes. However, in exceptional cases, such materials must be used in order to achieve specific physical and electrical properties because no safe substitute materials are currently known. However, the amount of dangerous materials used in our products has been limited to an absolute minimum. Nevertheless, the following rules should be observed when handling Al electrolytic capacitors:

- Any escaping electrolyte should not come into contact with eyes or skin.
- If electrolyte does come into contact with the skin, wash the affected parts immediately with running water. If the eyes are affected, rinse them for 10 minutes with plenty of water. If symptoms persist, seek medical treatment.
- Avoid breathing in electrolyte vapor or mists. Workplaces and other affected areas should be well ventilated. Clothing that has been contaminated by electrolyte must be changed and rinsed in water.

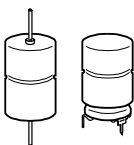

B41692, B41792

Long useful life, compact – up to 140 °C

Product safety

The table below summarize the safety instructions that must be observed without fail. A detailed description can be found in the relevant sections of chapter "General technical information".

Topic	Safety information	Reference Chapter "General technical information"
Polarity	Make sure that polar capacitors are connected with the right polarity.	1 "Basic construction of aluminum electrolytic capacitors"
Reverse voltage	Voltages polarity classes should be prevented by connecting a diode.	3.1.6 "Reverse voltage"
Upper category temperature	Do not exceed the upper category temperatur.	7.2 "Maximum permissible operating temperature"
Maintenance	Make periodic inspections of the capacitors. Before the inspection, make sure that the power supply is turned off and carefully discharge the electricity of the capacitors. Do not apply any mechanical stress to the capacitor terminals.	10 "Maintenance"
Mounting position of screw terminal capacitors	Do not mount the capacitor with the terminals (safety vent) upside down.	11.1. "Mounting positions of capacitors with screw terminals"
Mounting of single-ended capacitors	The internal structure of single-ended capacitors might be damaged if excessive force is applied to the lead wires. Avoid any compressive, tensile or flexural stress. Do not move the capacitor after soldering to PC board. Do not pick up the PC board by the soldered capacitor. Do not insert the capacitor on the PC board with a hole space different to the lead space specified.	11.4 "Mounting considerations for single-ended capacitors"
Robustness of terminals	The following maximum tightening torques must not be exceeded when connecting screw terminals: M5: 2 Nm M6: 2.5 Nm	11.3 "Mounting torques"
Soldering	Do not exceed the specified time or temperature limits during soldering.	11.5 "Soldering"

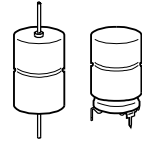

Topic	Safety information	Reference Chapter "General technical information"
Soldering, cleaning agents	Do not allow halogenated hydrocarbons to come into contact with aluminum electrolytic capacitors.	11.6 "Cleaning agents"
Passive flammability	Avoid external energy, such as fire or electricity.	8.1 "Passive flammability"
Active flammability	Avoid overload of the capacitors.	8.2 "Active flammability"
		Reference Chapter "Capacitors with screw terminals"
Breakdown strength of insulating sleeves	Do not damage the insulating sleeve, especially when ring clips are used for mounting.	"Screw terminals - accessories"

Important notes

The following applies to all products named in this publication:

1. Some parts of this publication contain **statements about the suitability of our products for certain areas of application**. These statements are based on our knowledge of typical requirements that are often placed on our products in the areas of application concerned. We nevertheless expressly point out **that such statements cannot be regarded as binding statements about the suitability of our products for a particular customer application**. As a rule, EPCOS is either unfamiliar with individual customer applications or less familiar with them than the customers themselves. For these reasons, it is always ultimately incumbent on the customer to check and decide whether an EPCOS product with the properties described in the product specification is suitable for use in a particular customer application.
2. We also point out that **in individual cases, a malfunction of passive electronic components or failure before the end of their usual service life cannot be completely ruled out in the current state of the art, even if they are operated as specified**. In customer applications requiring a very high level of operational safety and especially in customer applications in which the malfunction or failure of a passive electronic component could endanger human life or health (e.g. in accident prevention or life-saving systems), it must therefore be ensured by means of suitable design of the customer application or other action taken by the customer (e.g. installation of protective circuitry or redundancy) that no injury or damage is sustained by third parties in the event of malfunction or failure of a passive electronic component.
3. **The warnings, cautions and product-specific notes must be observed.**
4. In order to satisfy certain technical requirements, **some of the products described in this publication may contain substances subject to restrictions in certain jurisdictions (e.g. because they are classed as “hazardous”)**. Useful information on this will be found in our Material Data Sheets on the Internet (www.epcos.com/material). Should you have any more detailed questions, please contact our sales offices.
5. We constantly strive to improve our products. Consequently, **the products described in this publication may change from time to time**. The same is true of the corresponding product specifications. Please check therefore to what extent product descriptions and specifications contained in this publication are still applicable before or when you place an order. We also **reserve the right to discontinue production and delivery of products**. Consequently, we cannot guarantee that all products named in this publication will always be available.
6. Unless otherwise agreed in individual contracts, **all orders are subject to the current version of the “General Terms of Delivery for Products and Services in the Electrical Industry” published by the German Electrical and Electronics Industry Association (ZVEI)**.
7. The trade names EPCOS, EPCOS-JONES, BAOKE, Alu-X, CeraDiode, CSSP, MLSC, PhaseCap, PhaseMod, SIFERRIT, SIFI, SIKOREL, SilverCap, SIMID, SIOV, SIP5D, SIP5K, UltraCap, WindCap are **trademarks registered or pending** in Europe and in other countries. Further information will be found on the Internet at www.epcos.com/trademarks.