

FEATURES

- 450V/ μ s Slew Rate
- 100MHz Gain Bandwidth Product
- Wide Supply Range 2.7V to 12.6V
- Output Swings Rail-to-Rail
- Input Common Mode Range Includes Ground
- High Output Drive: 50mA
- Channel Separation: 90dB at 10MHz
- Specified on 3V, 5V, and \pm 5V Supplies
- Input Offset Voltage: 1mV
- Low Power Dissipation: 20mW Per Amplifier on Single 5V
- Operating Temperature Range: -40°C to 125°C
- Single in SOT-23, Dual in MSOP,
Quad in SSOP Package

APPLICATIONS

- Video Line Driver
- Automotive Displays
- RGB Amplifiers
- Coaxial Cable Drivers
- Low Voltage High Speed Signal Processing

DESCRIPTION

The LT[®]6205/LT6206/LT6207 are low cost single/dual/quad voltage feedback amplifiers that feature 100MHz gain-bandwidth product, 450V/ μ s slew rate and 50mA output current. These amplifiers have an input range that includes ground and an output that swings within 60mV of either supply rail, making them well suited for single supply operation.

These amplifiers maintain their performance for supplies from 2.7V to 12.6V and are specified at 3V, 5V and \pm 5V. The inputs can be driven beyond the supplies without damage or phase reversal of the output. Isolation between channels is high, over 90dB at 10MHz.

The LT6205 is available in the 5-pin SOT-23, and the LT6206 is available in an 8-lead MSOP package with standard op amp pin-outs. For compact layouts the quad LT6207 is available in the 16-pin SSOP package. These devices are specified over the commercial, industrial, and automotive temperature ranges.

LT, LT, LTC and LTM are registered trademarks of Linear Technology Corporation. All other trademarks are the property of their respective owners.

TYPICAL APPLICATION

Baseband Video Splitter/Cable Driver

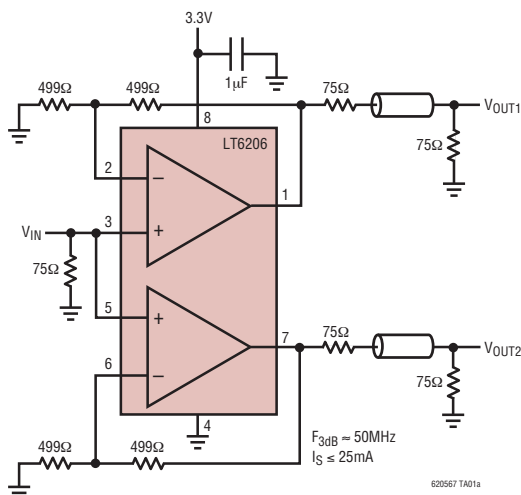

Output Step Response

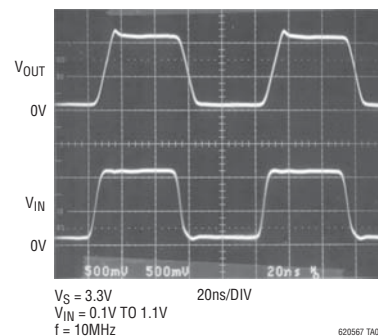

LT6205/LT6206/LT6207

ABSOLUTE MAXIMUM RATINGS (Note 1)

Total Supply Voltage (V^+ to V^-).....	12.6V	Specified Temperature Range (Note 4)	
Input Current	$\pm 10\text{mA}$	LT6205C/LT6206C/LT6207C	0°C to 70°C
Input Voltage Range (Note 2).....	$\pm V_S$	LT6205I/LT6206I/LT6207I	-40°C to 85°C
Output Short-Circuit Duration (Note 3)	Indefinite	LT6205H	-40°C to 125°C
Pin Current While Exceeding Supplies (Note 9) ...	$\pm 25\text{mA}$	Storage Temperature Range	-65°C to 150°C
Operating Temperature Range (Note 4)		Maximum Junction Temperature	150°C
LT6205C/LT6206C/LT6207C,		Lead Temperature (Soldering, 10 sec)	300°C
LT6205I/LT6206I/LT6207I	-40°C to 85°C		
LT6205H	-40°C to 125°C		

PIN CONFIGURATION

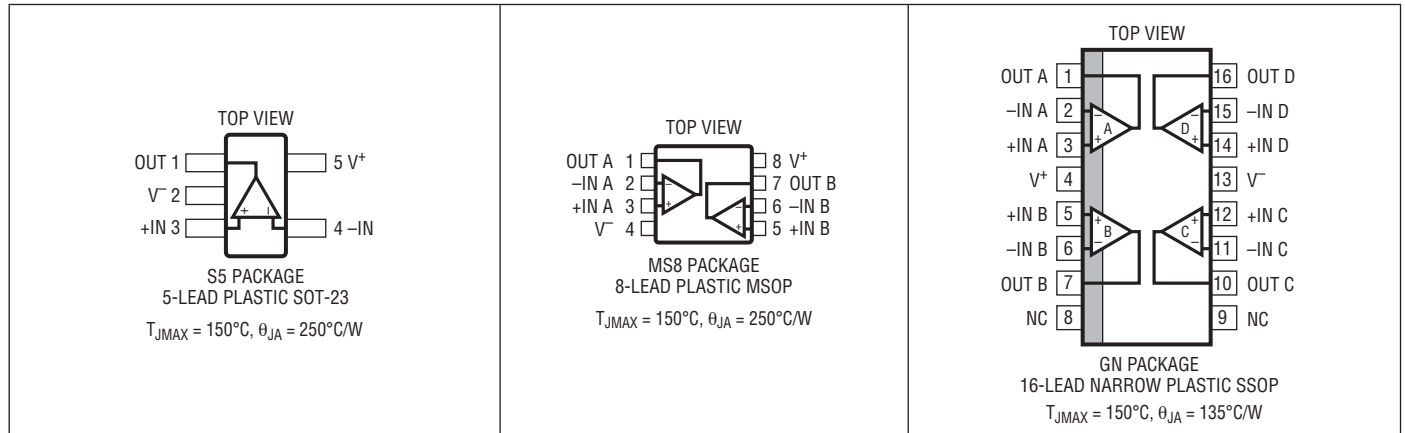

ORDER INFORMATION

LEAD FREE FINISH	TAPE AND REEL	PART MARKING	PACKAGE DESCRIPTION	TEMPERATURE RANGE
LT6205CS5#PBF	LT6205CS5#TRPBF	LTAEM*	5-Lead Plastic SOT-23	-40°C to 85°C
LT6205IS5#PBF	LT6205IS5#TRPBF	LTAEM*	5-Lead Plastic SOT-23	-40°C to 85°C
LT6205HS5#PBF	LT6205HS5#TRPBF	LTAEM*	5-Lead Plastic SOT-23	-40°C to 125°C
LT6206CMS8#PBF	LT6206CMS8#TRPBF	LTH3	8-Lead Plastic MSOP	-40°C to 85°C
LT6206IMS8#PBF	LT6206IMS8#TRPBF	LTH4	8-Lead Plastic MSOP	-40°C to 85°C
LT6207CGN#PBF	LT6207CGN#TRPBF	6207	16-Lead Narrow Plastic SSOP	-40°C to 85°C
LT6207IGN#PBF	LT6207IGN#TRPBF	6207I	16-Lead Narrow Plastic SSOP	-40°C to 85°C

Consult LTC Marketing for parts specified with wider operating temperature ranges. *The temperature grade is identified by a label on the shipping container. Consult LTC Marketing for information on non-standard lead based finish parts.

For more information on lead free part marking, go to: <http://www.linear.com/leadfree/>

For more information on tape and reel specifications, go to: <http://www.linear.com/tapeandree/>

ELECTRICAL CHARACTERISTICS The ● denotes specifications which apply over the specified temperature range, otherwise specifications are at $T_A = 25^\circ\text{C}$. $V_S = 3\text{V}, 0\text{V}$; $V_S = 5\text{V}, 0\text{V}$; $V_{CM} = V_{OUT} = 1\text{V}$, unless otherwise noted.

SYMBOL	PARAMETER	CONDITIONS	LT6205C/LT6206C/LT6207C LT6205I/LT6206I/LT6207I			UNITS	
			MIN	TYP	MAX		
V_{OS}	Input Offset Voltage		●	1	3.5 5	mV mV	
	Input Offset Voltage Match (Channel-toChannel) (Note 5)		●	1	3 4	mV mV	
	Input Offset Voltage Drift (Note 6)		●	7	15	$\mu\text{V}/^\circ\text{C}$	
I_B	Input Bias Current		●	10	30	μA	
I_{OS}	Input Offset Current		●	0.6	3	μA	
	Input Noise Voltage	0.1Hz to 10Hz		2		μV_{P-P}	
e_n	Input Noise Voltage Density	$f = 10\text{kHz}$		9		$\text{nV}/\sqrt{\text{Hz}}$	
i_n	Input Noise Current Density	$f = 10\text{kHz}$		4		$\text{pA}/\sqrt{\text{Hz}}$	
	Input Resistance	$V_{CM} = 0\text{V}$ to $V^+ - 2\text{V}$		1		$\text{M}\Omega$	
	Input Capacitance			2		pF	
CMRR	Common Mode Rejection Ratio	$V_{CM} = 0\text{V}$ to $V^+ - 2\text{V}$	●	78	90	dB	
	Input Voltage Range		●	0	$V^+ - 2$	V	
PSRR	Power Supply Rejection Ratio	$V_S = 3\text{V}$ to 12V $V_{CM} = V_{OUT} = 0.5\text{V}$	●	67	75	dB	
	Minimum Supply Voltage	$V_{CM} = 0.5\text{V}$	●		2.7	V	
A_{VOL}	Large-Signal Voltage Gain	$V_S = 5\text{V}, V_O = 0.5\text{V}$ to $4.5\text{V}, R_L = 1\text{k}$	●	30	100	V/mV	
		$V_S = 5\text{V}, V_O = 1\text{V}$ to $3\text{V}, R_L = 150\Omega$	●	5	20	V/mV	
		$V_S = 3\text{V}, V_O = 0.5\text{V}$ to $2.5\text{V}, R_L = 1\text{k}$	●	20	60	V/mV	
V_{OL}	Output Voltage Swing Low (Note 7)	No Load, Input Overdrive = 30mV	●		10	25	mV
		$I_{SINK} = 5\text{mA}$	●		75	150	mV
		$V_S = 5\text{V}, I_{SINK} = 25\text{mA}$	●		300	500	mV
		$V_S = 3\text{V}, I_{SINK} = 15\text{mA}$	●		200	350	mV
V_{OH}	Output Voltage Swing High (Note 7)	No Load, Input Overdrive = 30mV	●		60	100	mV
		$I_{SOURCE} = 5\text{mA}$	●		150	250	mV
		$V_S = 5\text{V}, I_{SOURCE} = 25\text{mA}$	●		650	1200	mV
		$V_S = 3\text{V}, I_{SOURCE} = 15\text{mA}$	●		300	500	mV
I_{SC}	Short-Circuit Current	$V_S = 5\text{V}$, Output Shorted to GND	●	35 20	60	mA mA	
		$V_S = 3\text{V}$, Output Shorted to GND	●	30 20	50	mA mA	
I_S	Supply Current per Amplifier		●	3.75	5 5.75	mA mA	
GBW	Gain Bandwidth Product	$f = 2\text{MHz}$	●	65	100	MHz	
SR	Slew Rate	$V_S = 5\text{V}, A_V = 2, R_F = R_G = 1\text{k}$ $V_O = 1\text{V}$ to 4V , Measured from 1.5V to 3.5V			450	$\text{V}/\mu\text{s}$	
		Channel Separation	$f = 10\text{MHz}$		90	dB	
FPBW	Full Power Bandwidth	$V_{OUT} = 2V_{P-P}$ (Note 8)		71		MHz	
t_s	Settling time to 3% Settling time to 1%	$V_S = 5\text{V}, \Delta V_{OUT} = 2\text{V}, A_V = -1, R_L = 150\Omega$		15	25	ns ns	
		Differential Gain Differential Phase	$V_S = 5\text{V}, A_V = 2, R_L = 150\Omega$, Output Black Level = 1V $V_S = 5\text{V}, A_V = 2, R_L = 150\Omega$, Output Black Level = 1V		0.05 0.08	% Deg	

LT6205/LT6206/LT6207

ELECTRICAL CHARACTERISTICS The ● denotes specifications which apply over the specified temperature range, otherwise specifications are at $T_A = 25^\circ\text{C}$. $V_S = \pm 5\text{V}$; $V_{CM} = V_{OUT} = 0\text{V}$, unless otherwise noted.

SYMBOL	PARAMETER	CONDITIONS	LT6205C/LT6206C/LT6207C LT6205I/LT6206I/LT6207I			UNITS
			MIN	TYP	MAX	
V_{OS}	Input Offset Voltage		●	1	4.5 6	mV mV
	Input Offset Voltage Match (Channel-toChannel) (Note 5)		●	1	3 4	mV mV
	Input Offset Voltage Drift (Note 6)		●	10	18	$\mu\text{V}/^\circ\text{C}$
I_B	Input Bias Current		●	18	30	μA
I_{OS}	Input Offset Current		●	0.6	3	μA
	Input Noise Voltage	0.1Hz to 10Hz		2		μV_{P-P}
e_n	Input Noise Voltage Density	$f = 10\text{kHz}$		9		$\text{nV}/\sqrt{\text{Hz}}$
i_n	Input Noise Current Density	$f = 10\text{kHz}$		4		$\text{pA}/\sqrt{\text{Hz}}$
	Input Resistance	$V_{CM} = -5\text{V}$ to 3V		1		$\text{M}\Omega$
	Input Capacitance			2		pF
CMRR	Common Mode Rejection Ratio	$V_{CM} = -5\text{V}$ to 3V	●	78	90	dB
	Input Voltage Range		●	-5	3	V
PSRR	Power Supply Rejection Ratio	$V_S = \pm 2\text{V}$ to $\pm 6\text{V}$	●	67	75	dB
A_{VOL}	Large-Signal Voltage Gain	$V_O = -4\text{V}$ to 4V , $R_L = 1\text{k}$	●	50	133	V/mV
		$V_O = -3\text{V}$ to 3V , $R_L = 150\Omega$	●	7.5	20	V/mV
I_{SC}	Output Voltage Swing	No Load, Input Overdrive = 30mV	●	± 4.88	± 4.92	V
		$I_{OUT} = \pm 5\text{mA}$	●	± 4.75	± 4.85	V
		$I_{OUT} = \pm 25\text{mA}$	●	± 3.8	± 4.35	V
I_{SC}	Short-Circuit Current	Short to Ground	●	± 40 ± 30	± 60	mA mA
I_S	Supply Current per Amplifier		●	4	5.6 6.5	mA mA
GBW	Gain Bandwidth Product	$f = 2\text{MHz}$	●	65	100	MHz
SR	Slew Rate	$A_V = -1$, $R_L = 1\text{k}$ $V_O = -4\text{V}$ to 4V , Measured from -3V to 3V		350	600	$\text{V}/\mu\text{s}$
	Channel Separation	$f = 10\text{MHz}$		90		dB
FPBW	Full Power Bandwidth	$V_{OUT} = 8\text{V}_{P-P}$ (Note 8)		14	24	MHz
t_s	Settling time to 3% Settling time to 1%	$\Delta V_{OUT} = 2\text{V}$, $A_V = -1$, $R_L = 150\Omega$		15		ns
				25		ns
	Differential Gain	$A_V = 2$, $R_L = 150\Omega$, Output Black Level = 1V		0.05		%
	Differential Phase	$A_V = 2$, $R_L = 150\Omega$, Output Black Level = 1V		0.08		Deg

The ● denotes specifications which apply over the full specified temperature range, $-40^\circ\text{C} \leq T_A \leq 125^\circ\text{C}$, otherwise specifications are at $T_A = 25^\circ\text{C}$. $V_S = 3\text{V}$, 0V ; $V_S = 5\text{V}$, 0V ; $V_{CM} = V_{OUT} = 1\text{V}$, unless otherwise noted.

SYMBOL	PARAMETER	CONDITIONS	LT6205H			UNITS
			MIN	TYP	MAX	
V_{OS}	Input Offset Voltage		●	1	3.5 6	mV mV
	Input Offset Voltage Drift (Note 6)		●		20	$\mu\text{V}/^\circ\text{C}$
I_B	Input Bias Current		●		45	μA

620567fa

ELECTRICAL CHARACTERISTICS The ● denotes specifications which apply over the full specified temperature range, $-40^{\circ}\text{C} \leq T_A \leq 125^{\circ}\text{C}$, otherwise specifications are at $T_A = 25^{\circ}\text{C}$. $V_S = 3\text{V}, 0\text{V}$; $V_S = 5\text{V}, 0\text{V}$; $V_{\text{CM}} = V_{\text{OUT}} = 1\text{V}$, unless otherwise noted.

SYMBOL	PARAMETER	CONDITIONS	LT6205H			UNITS
			MIN	TYP	MAX	
I_{OS}	Input Offset Current	●			5	μA
	Input Noise Voltage	0.1Hz to 10Hz		2		$\mu\text{V}_{\text{P-P}}$
e_n	Input Noise Voltage Density	$f = 10\text{kHz}$		9		$\text{nV}/\sqrt{\text{Hz}}$
i_n	Input Noise Current Density	$f = 10\text{kHz}$		4		$\text{pA}/\sqrt{\text{Hz}}$
	Input Resistance	$V_{\text{CM}} = 0\text{V to } V^+ - 2\text{V}$		1		$\text{M}\Omega$
	Input Capacitance			2		pF
CMRR	Common Mode Rejection Ratio	$V_{\text{CM}} = 0\text{V to } V^+ - 2\text{V}$	●	72		dB
	Input Voltage Range	●	0		$V^+ - 2$	V
PSRR	Power Supply Rejection Ratio	$V_S = 3\text{V to } 12\text{V}$ $V_{\text{CM}} = V_{\text{OUT}} = 0.5\text{V}$	●	62		dB
	Minimum Supply Voltage	$V_{\text{CM}} = 0.5\text{V}$	●		2.7	V
A_{VOL}	Large-Signal Voltage Gain	$V_S = 5\text{V}, V_0 = 0.5\text{V to } 4.5\text{V}, R_L = 1\text{k}$ $V_S = 5\text{V}, V_0 = 1\text{V to } 3\text{V}, R_L = 150\Omega$ $V_S = 3\text{V}, V_0 = 0.5\text{V to } 2.5\text{V}, R_L = 1\text{k}$	● ● ●	25 3.5 15		V/mV V/mV V/mV
V_{OL}	Output Voltage Swing Low (Note 7)	No Load, Input Overdrive = 30mV $I_{\text{SINK}} = 5\text{mA}$ $V_S = 5\text{V}, I_{\text{SINK}} = 25\text{mA}$ $V_S = 3\text{V}, I_{\text{SINK}} = 15\text{mA}$	● ● ● ●		40 200 600 400	mV mV mV mV
V_{OH}	Output Voltage Swing High (Note 7)	No Load, Input Overdrive = 30mV $I_{\text{SOURCE}} = 5\text{mA}$ $V_S = 5\text{V}, I_{\text{SOURCE}} = 25\text{mA}$ $V_S = 3\text{V}, I_{\text{SOURCE}} = 15\text{mA}$	● ● ● ●		125 300 1400 600	mV mV mV mV
I_{SC}	Short-Circuit Current	$V_S = 5\text{V}$, Output Shorted to GND	●	35 20	60	mA mA
		$V_S = 3\text{V}$, Output Shorted to GND	●	30 15	50	mA mA
I_S	Supply Current per Amplifier	●		3.75	5 6.5	mA mA
GBW	Gain Bandwidth Product	$f = 2\text{MHz}$	●	50		MHz
SR	Slew Rate	$V_S = 5\text{V}, A_V = 2, R_F = R_G = 1\text{k}$ $V_0 = 1\text{V to } 4\text{V}$, Measured from 1.5V to 3.5V			450	$\text{V}/\mu\text{s}$
	Channel Separation	$f = 10\text{MHz}$			90	dB
FPBW	Full Power Bandwidth	$V_{\text{OUT}} = 2\text{V}_{\text{P-P}}$ (Note 8)			71	MHz
t_s	Settling time to 3% Settling time to 1%	$V_S = 5\text{V}, \Delta V_{\text{OUT}} = 2\text{V}, A_V = -1, R_L = 150\Omega$			15 25	ns ns
	Differential Gain	$V_S = 5\text{V}, A_V = 2, R_L = 150\Omega$, Output Black Level = 1V			0.05	$\%$
	Differential Phase	$V_S = 5\text{V}, A_V = 2, R_L = 150\Omega$, Output Black Level = 1V			0.08	Deg

The ● denotes specifications which apply over the full specified temperature range, $-40^{\circ}\text{C} \leq T_A \leq 125^{\circ}\text{C}$, otherwise specifications are at $T_A = 25^{\circ}\text{C}$. $V_S = \pm 5\text{V}$; $V_{\text{CM}} = V_{\text{OUT}} = 0\text{V}$, unless otherwise noted.

SYMBOL	PARAMETER	CONDITIONS	LT6205H			UNITS
			MIN	TYP	MAX	
V_{OS}	Input Offset Voltage	●		1.3	4.5 7	mV mV
	Input Offset Voltage Drift (Note 6)	●			25	$\mu\text{V}/^{\circ}\text{C}$

LT6205/LT6206/LT6207

ELECTRICAL CHARACTERISTICS The ● denotes specifications which apply over the full specified temperature range, $-40^{\circ}\text{C} \leq T_A \leq 125^{\circ}\text{C}$, otherwise specifications are at $T_A = 25^{\circ}\text{C}$. $V_S = \pm 5\text{V}$; $V_{\text{CM}} = V_{\text{OUT}} = 0\text{V}$, unless otherwise noted.

SYMBOL	PARAMETER	CONDITIONS	LT6205H			UNITS
			MIN	TYP	MAX	
I_B	Input Bias Current		●		50	μA
I_{OS}	Input Offset Current		●		5	μA
	Input Noise Voltage	0.1Hz to 10Hz		2		$\mu\text{V}_{\text{P-P}}$
e_n	Input Noise Voltage Density	$f = 10\text{kHz}$		9		$\text{nV}/\sqrt{\text{Hz}}$
i_n	Input Noise Current Density	$f = 10\text{kHz}$		4		$\text{pA}/\sqrt{\text{Hz}}$
	Input Resistance	$V_{\text{CM}} = -5\text{V to } 3\text{V}$		1		$\text{M}\Omega$
	Input Capacitance			2		pF
CMRR	Common Mode Rejection Ratio	$V_{\text{CM}} = -5\text{V to } 3\text{V}$	●	72		dB
	Input Voltage Range		●	-5	3	V
PSRR	Power Supply Rejection Ratio	$V_S = \pm 2\text{V to } \pm 6\text{V}$	●	62		dB
A_{VOL}	Large-Signal Voltage Gain	$V_O = -4\text{V to } 4\text{V}, R_L = 1\text{k}$	●	40		V/mV
		$V_O = -3\text{V to } 3\text{V}, R_L = 150\Omega$	●	5		V/mV
	Output Voltage Swing	No Load, Input Overdrive = 30mV $I_{\text{OUT}} = \pm 5\text{mA}$ $I_{\text{OUT}} = \pm 25\text{mA}$	● ● ●	± 4.85 ± 4.65 ± 3.5		V V V
I_{SC}	Short-Circuit Current	Short to Ground	●	± 40 ± 20	± 60	mA mA
I_S	Supply Current per Amplifier		●	4	5.6 7.5	mA mA
GBW	Gain Bandwidth Product	$f = 2\text{MHz}$	●	50		MHz
SR	Slew Rate	$A_V = -1, R_L = 1\text{k}$ $V_O = -4\text{V to } 4\text{V}$, Measured from $-3\text{V to } 3\text{V}$		350	600	$\text{V}/\mu\text{s}$
	Channel Separation	$f = 10\text{MHz}$			90	dB
FPBW	Full Power Bandwidth	$V_{\text{OUT}} = 8\text{V}_{\text{P-P}}$ (Note 8)		14	24	MHz
t_s	Settling time to 3% Settling time to 1%	$\Delta V_{\text{OUT}} = 2\text{V}, A_V = -1, R_L = 150\Omega$		15		ns
				25		ns
	Differential Gain	$A_V = 2, R_L = 150\Omega$, Output Black Level = 1V		0.05		$\%$
	Differential Phase	$A_V = 2, R_L = 150\Omega$, Output Black Level = 1V		0.08		Deg

Note 1: Stresses beyond those listed under Absolute Maximum Ratings may cause permanent damage to the device. Exposure to any Absolute Maximum Rating condition for extended periods may affect device reliability and lifetime.

Note 2: The inputs are protected by back-to-back diodes. If the differential input voltage exceeds 1.4V, the input current should be limited to less than 10mA.

Note 3: A heat sink may be required to keep the junction temperature below absolute maximum. This depends on the power supply voltage and how many amplifiers are shorted.

Note 4: The LT6205C/LT6206C/LT6207C are guaranteed to meet specified performance from 0°C to 70°C and are designed, characterized and expected to meet specified performance from -40°C to 85°C but are not tested or QA sampled at these temperatures. The LT6205I/LT6206I/LT6207I are guaranteed to meet specified performance from -40°C to 85°C . The LT6205H is guaranteed to meet specified performance from -40°C to 125°C .

Note 5: Matching parameters are the difference between the two amplifiers A and D and between B and C of the LT6207; between the two amplifiers of the LT6206.

Note 6: This parameter is not 100% tested.

Note 7: Output voltage swings are measured between the output and power supply rails.

Note 8: Full power bandwidth is calculated from the slew rate measurement: $\text{FPBW} = \text{SR}/2\pi V_{\text{PEAK}}$.

Note 9: There are reverse biased ESD diodes on all inputs and outputs. If these pins are forced beyond either supply, unlimited current will flow through these diodes. If the current is transient in nature and limited to less than 25mA, no damage to the device will occur.

TYPICAL PERFORMANCE CHARACTERISTICS

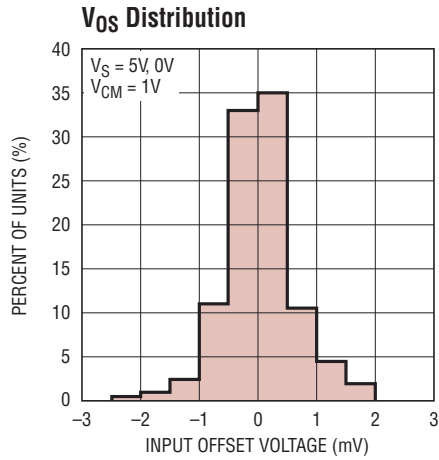

620567 G01

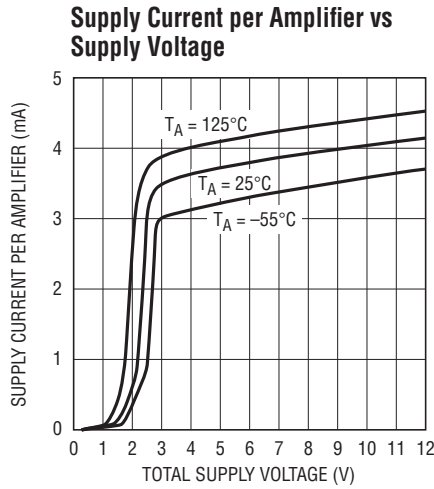

620567 G02

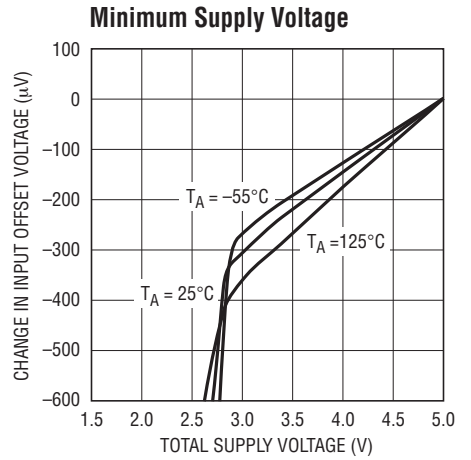

620567 G03

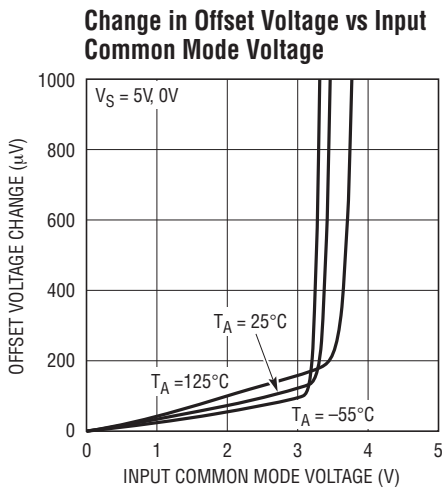

620567 G04

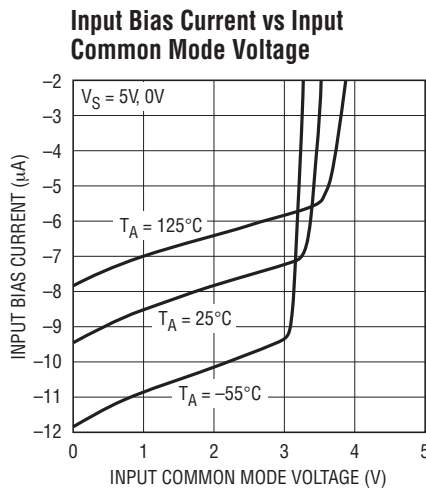

620567 G05

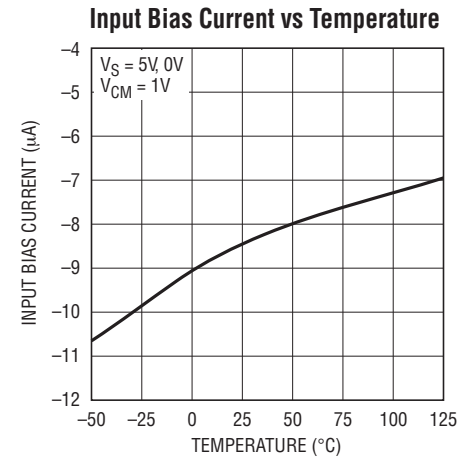

620567 G06

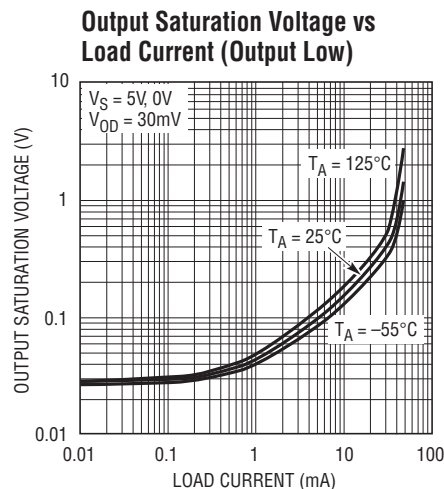

620567 G07

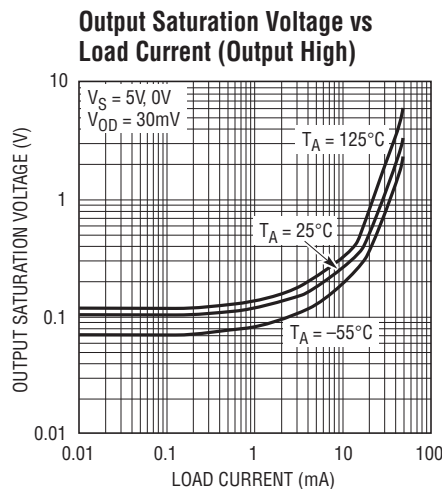

620567 G08

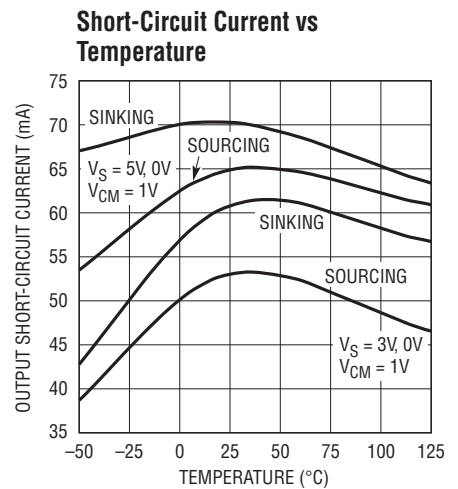

620567 G09

TYPICAL PERFORMANCE CHARACTERISTICS

Short-Circuit Current vs Temperature

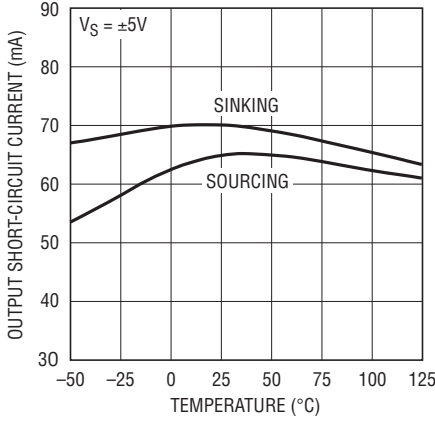

620567 G10

Open-Loop Gain

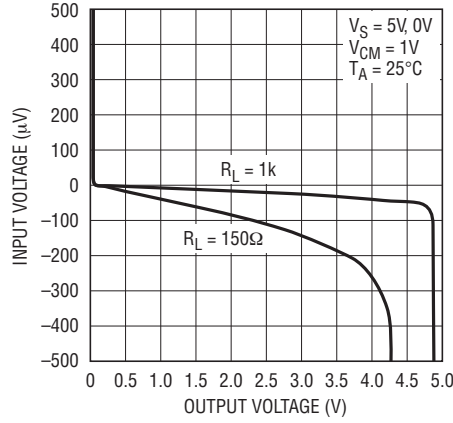

620567 G11

Open-Loop Gain

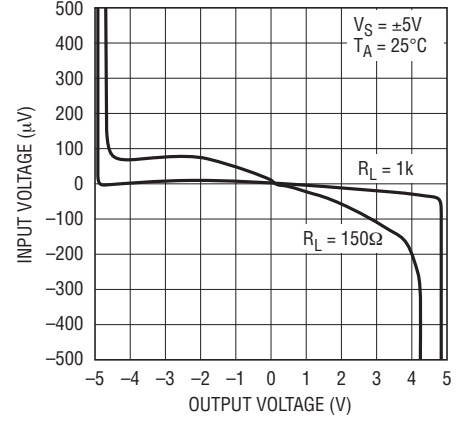

620567 G12

Warm Up Drift vs Time (LT6206)

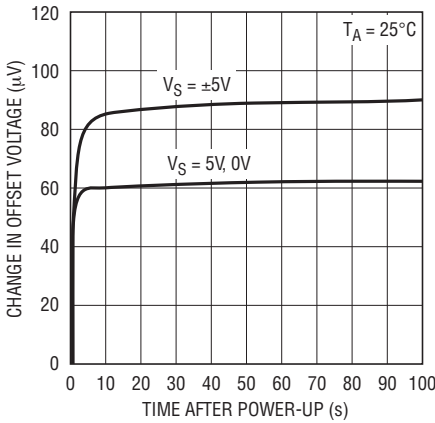

620567 G13

Input Noise Voltage Density vs Frequency

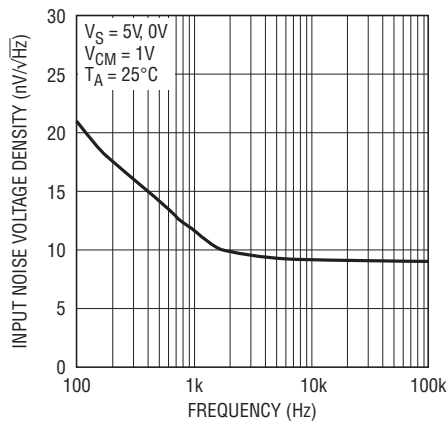

620567 G14

Input Noise Current Density vs Frequency

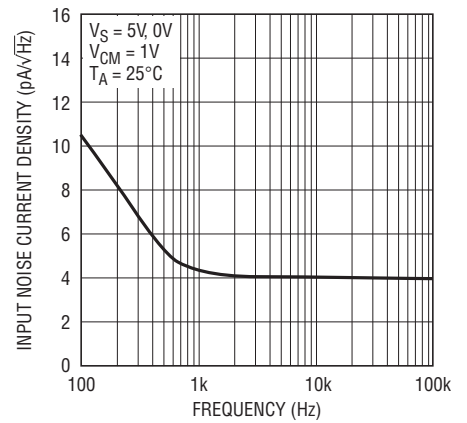

620567 G15

0.1Hz to 10Hz Noise Voltage

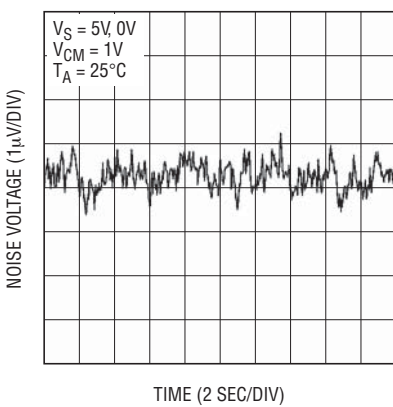

620567 G16

Gain and Phase vs Frequency

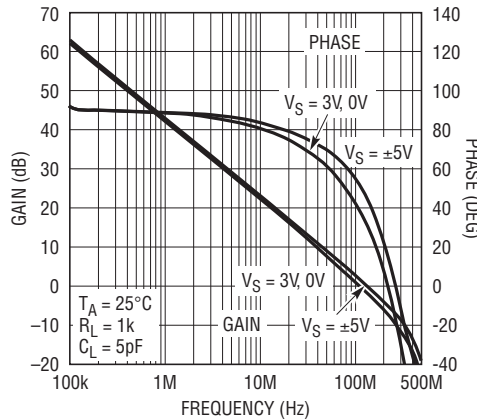

620567 G17

Gain Bandwidth and Phase Margin vs Supply Voltage

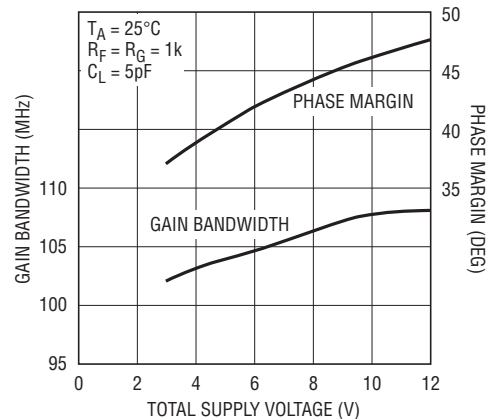

620567 G18

620567fa

TYPICAL PERFORMANCE CHARACTERISTICS

Gain Bandwidth and Phase Margin vs Temperature

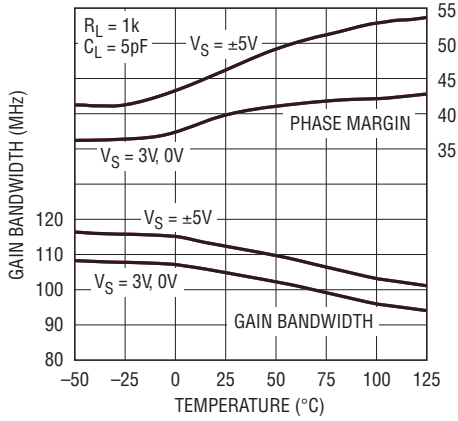

620567 G19

Slew Rate vs Temperature

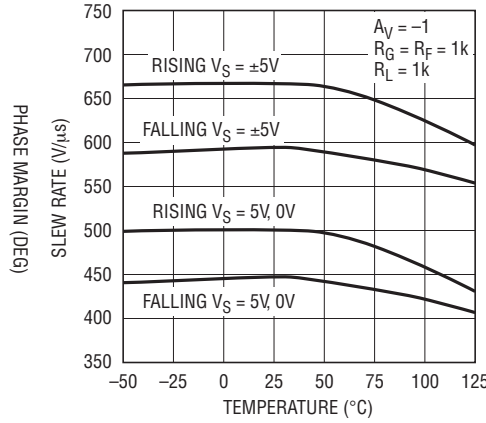

620567 G20

Slew Rate vs Closed-Loop Gain

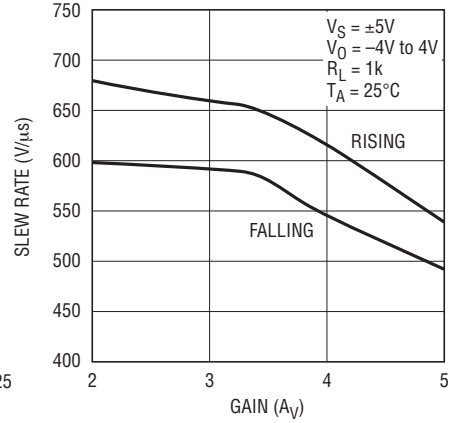

620567 G21

Closed-Loop Gain vs Frequency

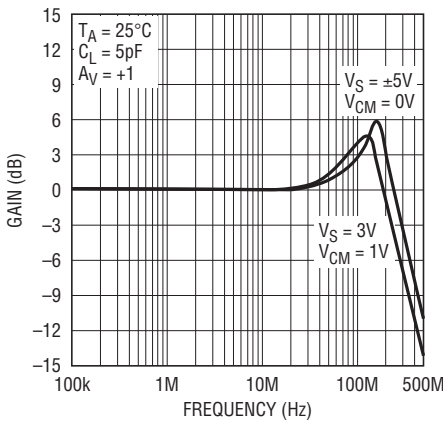

620567 G22

Output Impedance vs Frequency

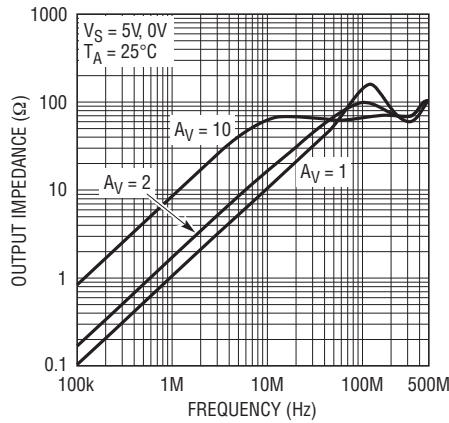

620567 G23

Power Supply Rejection Ratio vs Frequency

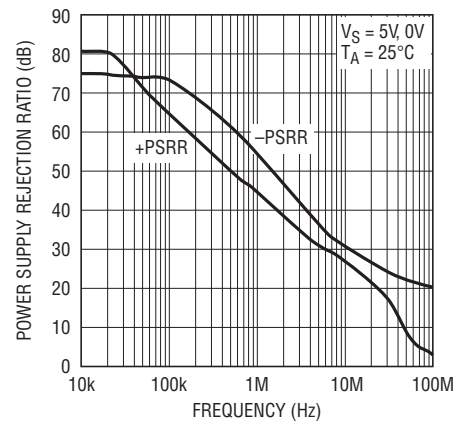

620567 G24

Common Mode Rejection Ratio vs Frequency

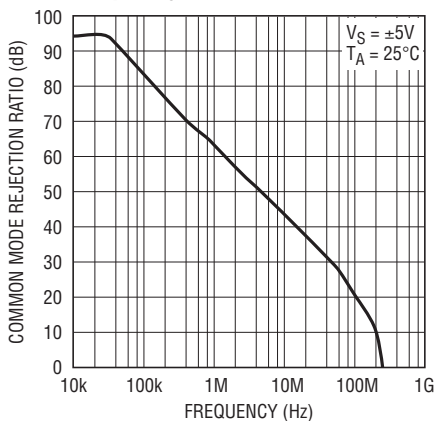

620567 G25

Channel Separation vs Frequency

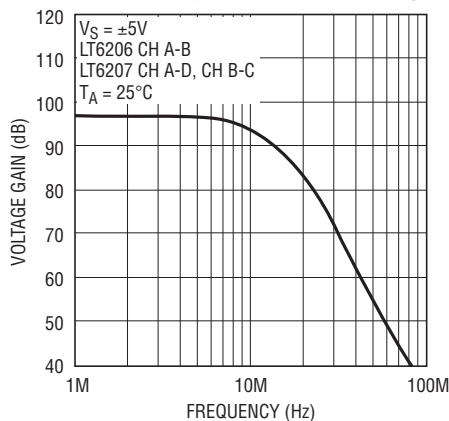

620567 G26

Series Output Resistor vs Capacitive Load

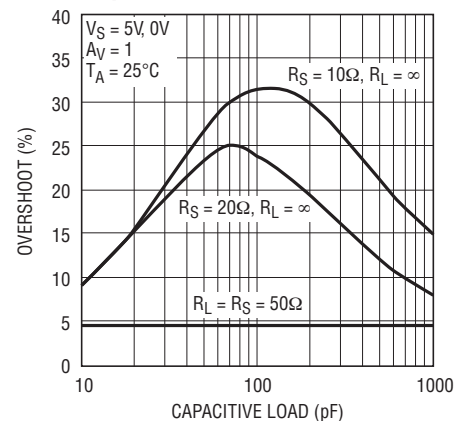

620567 G27

TYPICAL PERFORMANCE CHARACTERISTICS

Series Output Resistor vs Capacitive Load

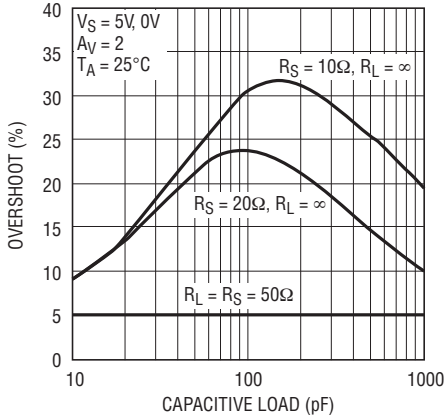

620567 G28

Maximum Undistorted Output Signal vs Frequency

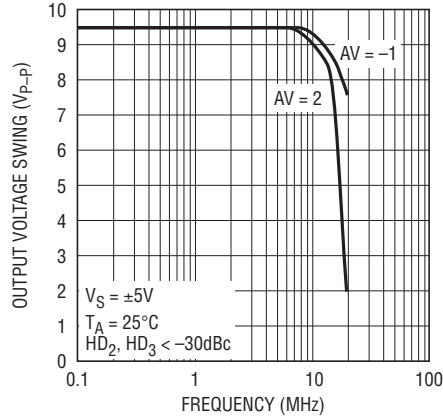

620567 G30

Distortion vs Frequency

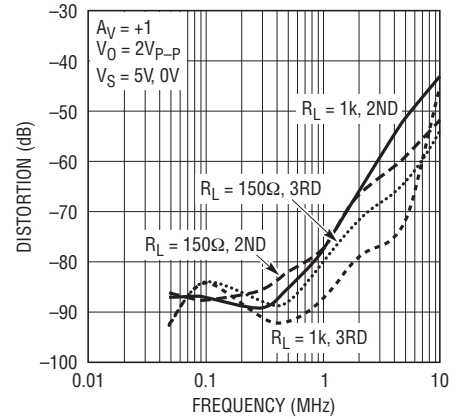

620567 G31

Distortion vs Frequency

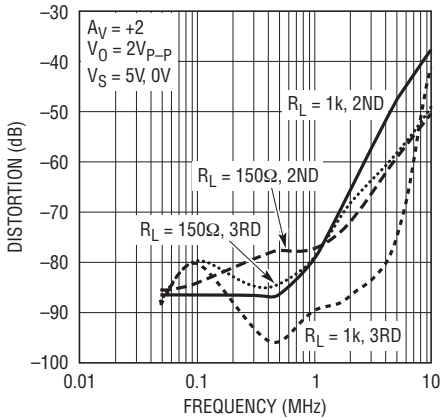

620567 G32

Distortion vs Frequency

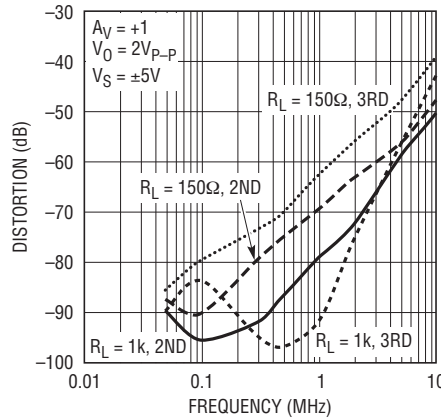

620567 G33

Distortion vs Frequency

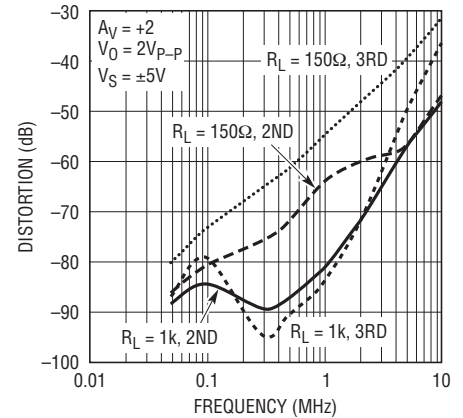

620567 G34

Large Signal Response VS = 5V, 0V

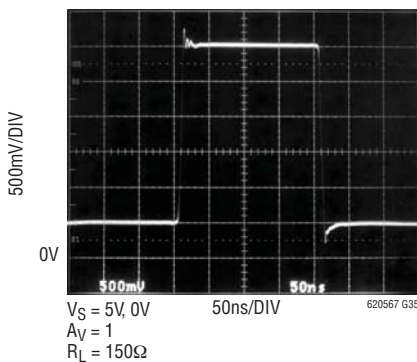

Small Signal Response VS = 5V, 0V

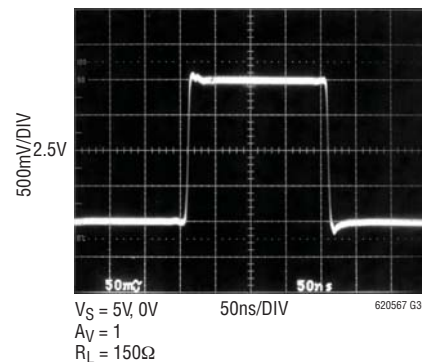

TYPICAL PERFORMANCE CHARACTERISTICS

Large Signal Response $V_S = \pm 5V$

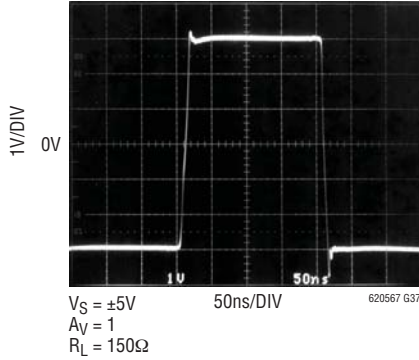

Small Signal Response $V_S = \pm 5V$

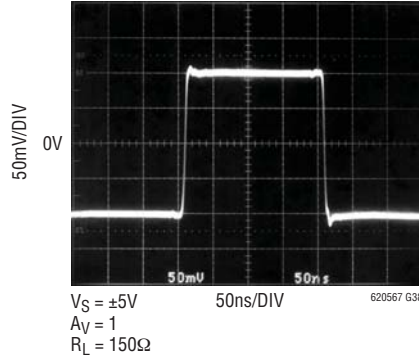

Output-Overdrive Recovery

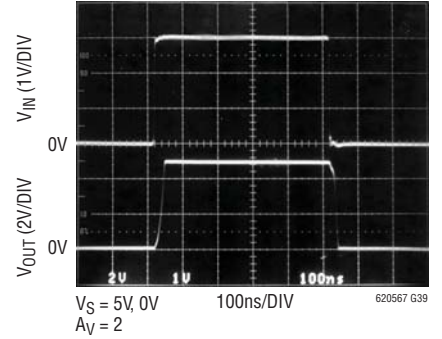

APPLICATIONS INFORMATION

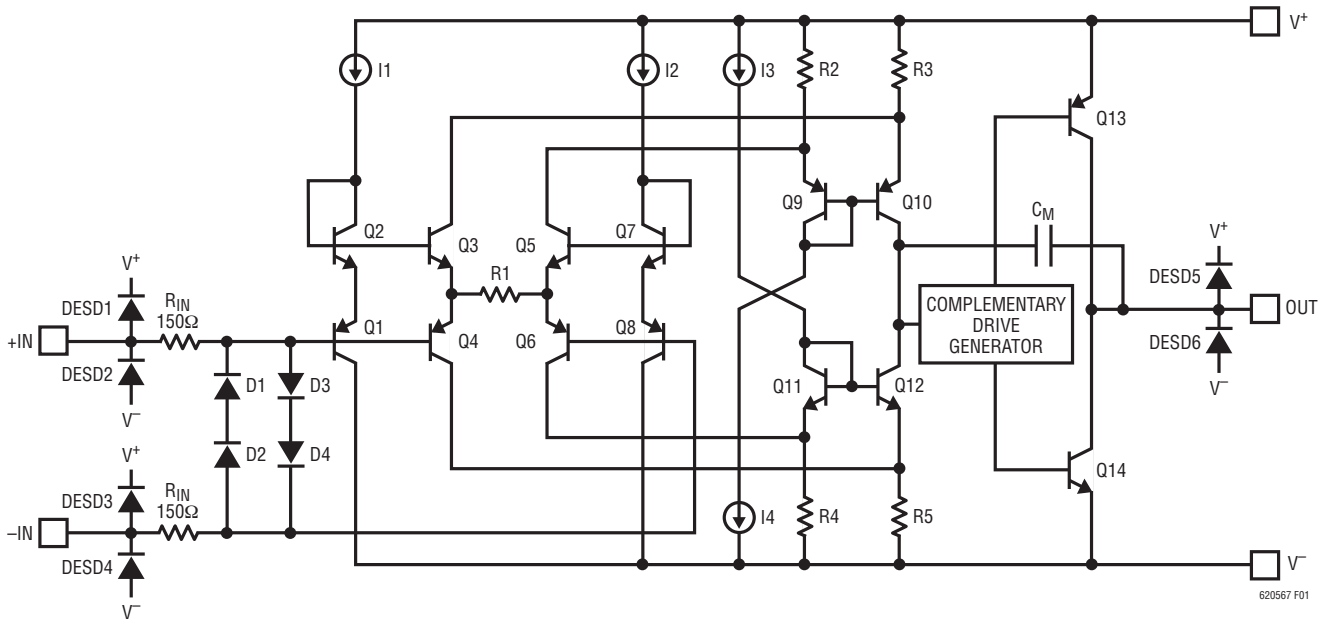

Figure 1. Simplified Schematic

APPLICATIONS INFORMATION

Amplifier Characteristics

Figure 1 shows a simplified schematic of the LT6205/LT6206/LT6207. The input stage consists of transistors Q1 to Q8 and resistor R1. This topology allows for high slew rates at low supply voltages. The input common mode range extends from ground to typically 1.75V from V_{CC} , and is limited by 2 VBEs plus a saturation voltage of a current source. There are back-to-back series diodes, D1 to D4, across the + and – inputs of each amplifier to limit the differential voltage to $\pm 1.4V$. R_{IN} limits the current through these diodes if the input differential voltage exceeds $\pm 1.4V$. The input stage drives the degeneration resistors of PNP and NPN current mirrors, Q9 to Q12, which convert the differential signals into a single-ended output. The complementary drive generator supplies current to the output transistors that swing from rail-to-rail.

The current generated through R1, divided by the capacitor C_M , determines the slew rate. Note that this current, and hence the slew rate, are proportional to the magnitude of the input step. The input step equals the output step divided by the closed loop gain. The highest slew rates are therefore obtained in the lowest gain configurations. The Typical Performance Characteristic Curve of Slew Rate vs Closed Loop Gain shows the details.

ESD

The LT6205/LT6206/LT6207 have reverse-biased ESD protection diodes on all inputs and outputs as shown in Figure 1. If these pins are forced beyond either supply unlimited current will flow through these diodes. If the current is transient, and limited to 25mA or less, no damage to the device will occur.

Layout and Passive Components

With a gain bandwidth product of 100MHz and a slew rate of 450V/ μ s the LT6205/LT6206/LT6207 require special attention to board layout and supply bypassing. Use a ground plane, short lead lengths and RF-quality low ESR supply bypass capacitors. The positive supply pin should be bypassed with a small capacitor (typically 0.01 μ F to 0.1 μ F) within 0.25 inches of the pin. When driving heavy loads, an additional 4.7 μ F electrolytic capacitor should be used. When using split supplies, the same is true for the

negative supply pin. For optimum performance all feedback components and bypass capacitors should be contained in a 0.5 inch by 0.5 inch area. This helps ensure minimal stray capacitances.

The parallel combination of the feedback resistor and gain setting resistor on the inverting input can combine with the input capacitance to form a pole which can degrade stability. In general, use feedback resistors of 1k or less.

Capacitive Load

The LT6205/LT6206/LT6207 are optimized for wide bandwidth video applications. They can drive a capacitive load of 20pF in a unity-gain configuration. When driving a larger capacitive load, a resistor of 10 Ω to 50 Ω should be connected between the output and the capacitive load to avoid ringing or oscillation. The feedback should still be taken from the output pin so that the resistor will isolate the capacitive load and ensure stability. The Typical Performance Curves show the output overshoot when driving a capacitive load with different series resistors.

Video Signal Characteristics

Composite video is the most commonly used signal in broadcast-grade products and includes Luma (or luminance, the intensity information), Chroma (the colorimetry information) and Sync (vertical and horizontal raster timing) elements combined into a single signal, NTSC and PAL being the common formats. Component video for entertainment systems include separate signal(s) for the Luma and Chroma (i.e. Y/C or YPbPr) with Sync generally applied to the Luma channel (Y signal). In some instances, native RGB signals (separate intensity information for each primary color: red, green, blue) will have Sync included as well. All the signal types that include Sync are electrically similar from a voltage-swing standpoint, though various timing and bandwidth relationships exist depending on the applicable standard.

The typical video waveforms that include Sync (including full composite) are specified to have nominal 1V_{P-P} amplitude. The lower 0.3V is reserved for “sync tips” that carry timing information, and by being at a lower potential than all the other information, represents blacker-than-black intensity, thereby causing scan retrace activity to

APPLICATIONS INFORMATION

be invisible on a CRT. The “black” level of the waveform is at (or “setup” very slightly above) the upper limit of the sync information. Waveform content above the black-level is intensity information, with peak brightness represented at the maximum signal level. In the case of composite video, the modulated color subcarrier is superimposed on the waveform, but the dynamics remain inside the $1V_{P-P}$ limit (a notable exception is the chroma ramp used for differential-gain and differential-phase measurements, which can reach $1.15V_{P-P}$).

DC-Coupled Video Amplifier Considerations

Typically video amplifiers drive cables that are series terminated (“back-terminated”) at the source and load-terminated at the destination with resistances equal to the cable characteristic impedance, Z_0 (usually 75Ω). This configuration forms a 2:1 resistor divider in the cabling that must be accounted for in the driver amplifier by delivering $2V_{P-P}$ output into an effective $2 \cdot Z_0$ load (e.g. 150Ω). Driving the cable can require more than 13mA while the output is approaching the saturation-limits of the amplifier output. The absolute minimum supply is: $V_{MIN} = 2 + V_{OH} + V_{OL}$. For example, the LT6206 dual operating on 3.3V as shown on the front page of this datasheet, with exceptionally low $V_{OH} \leq 0.5V$ and $V_{OL} \leq 0.35V$, provides a design margin of 0.45V. The design margin must be large enough to include supply variations and DC bias accuracy for the DC-coupled video input.

Handling AC-Coupled Video Signals

AC-coupled video inputs are intrinsically more difficult to handle than those with DC-coupling because the average signal voltage of the video waveform is effected by the picture content, meaning that the black-level at the amplifier “wanders” with scene brightness. The wander is measured as 0.56V for a $1V_{P-P}$ NTSC waveform changing from black-field to white-field and vice-versa, so an additional 1.12V allowance must be made in the amplifier supply (assuming gain of 2, so $V_{MIN} = 3.12 + V_{OH} + V_{OL}$). For example, an LT6205 operating on 5V has a conservative design margin of 1.03V. The amplifier output (for gain of 2) must swing +1.47V to $-1.65V$ around the DC-operating point, so the biasing circuitry needs to be designed accordingly for optimal fidelity.

Clamped AC-Input Cable Driver

A popular method of further minimizing supply requirements with AC-coupling is to employ a simple clamping scheme as shown in Figure 2. In this circuit, the LT6205 operates from 3.3V by having the sync-tips control the charge on the coupling capacitor C1, thereby reducing the black-level input wander to $\approx 0.07V$. The only minor drawback to this circuit is the slight sync-tip compression ($\approx 0.025V$ at input) due to the diode conduction current, though the picture content remains full fidelity. This circuit has nearly the design margin of its DC-coupled counterpart, at 0.31V (for this circuit, $V_{MIN} = 2.14 + V_{OH} + V_{OL}$). The clamp-diode anode bias is selected to set the sync-tip output voltage at or slightly above V_{OL} .

YPbPr to RGB Component-Video Converter

The back-page application uses the LT6207 quad to implement a minimum amplifier count topology to transcode consumer component-video into RGB. In this circuit, signals only pass through one active stage from any input to any output, with passive additions being performed by the cable back-termination resistors. The compromise in using passive output addition is that the amplifier outputs must be twice as large as that of a conventional cable driver. The Y-channel section also has the demanding requirement that it single-handedly drives all three outputs to full brightness during times of white content, so a helper current source is used to assure unclipped video when operating from $\pm 5V$ supplies. This circuit maps sync-on-Y to sync on all the RGB channels, and for best results should have input black-levels at 0V nominal to prevent clipping.

TYPICAL APPLICATION

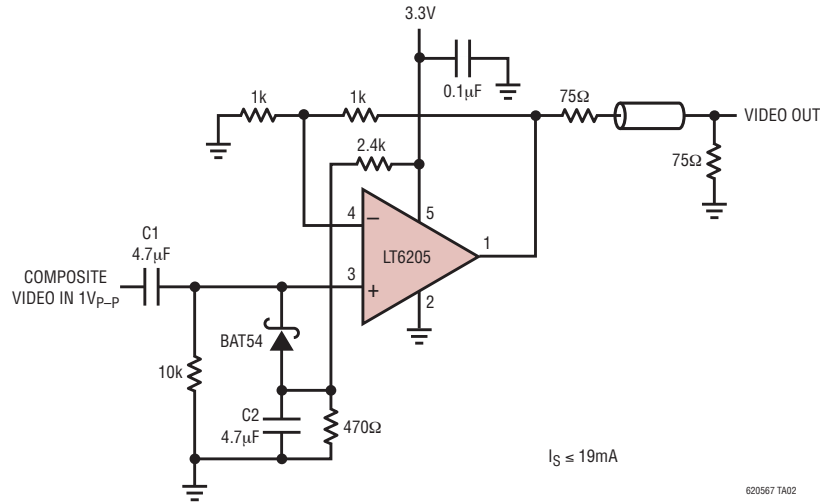
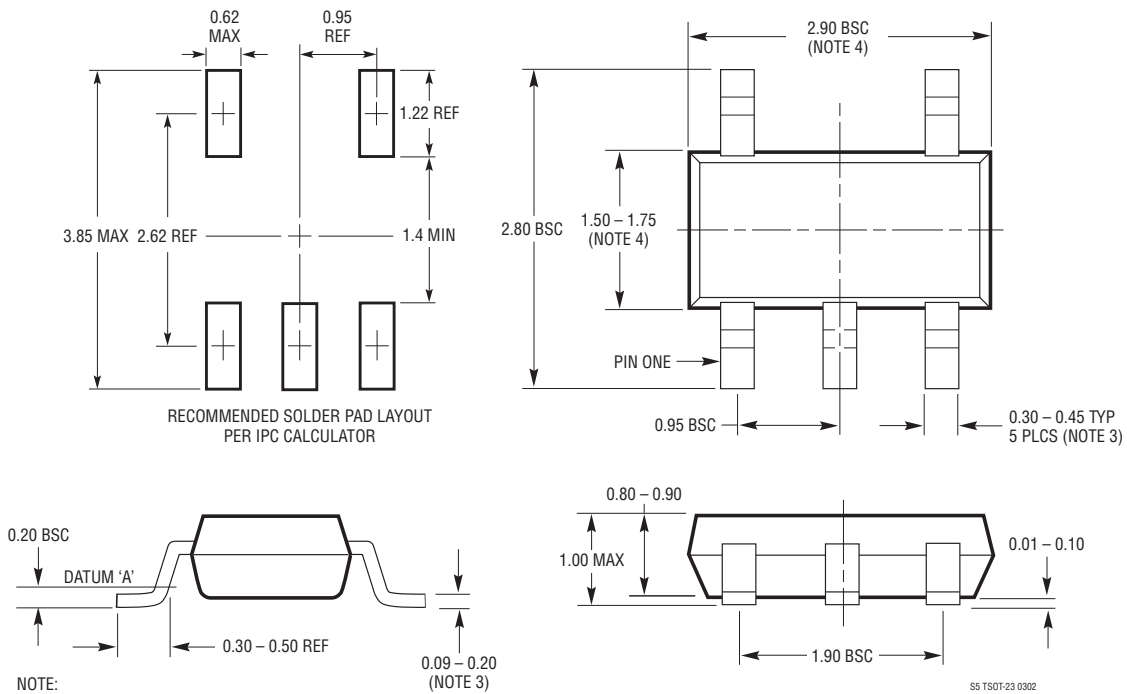

Figure 2. Clamped AC-Input Video Cable Driver

PACKAGE DESCRIPTION

S5 Package
5-Lead Plastic TSOT-23
 (Reference LTC DWG # 05-08-1635)



- NOTE:
1. DIMENSIONS ARE IN MILLIMETERS
 2. DRAWING NOT TO SCALE
 3. DIMENSIONS ARE INCLUSIVE OF PLATING
 4. DIMENSIONS ARE EXCLUSIVE OF MOLD FLASH AND METAL BURR
 5. MOLD FLASH SHALL NOT EXCEED 0.254mm
 6. JEDEC PACKAGE REFERENCE IS MO-193

TYPICAL APPLICATION

Y_PP_R to RGB Converter

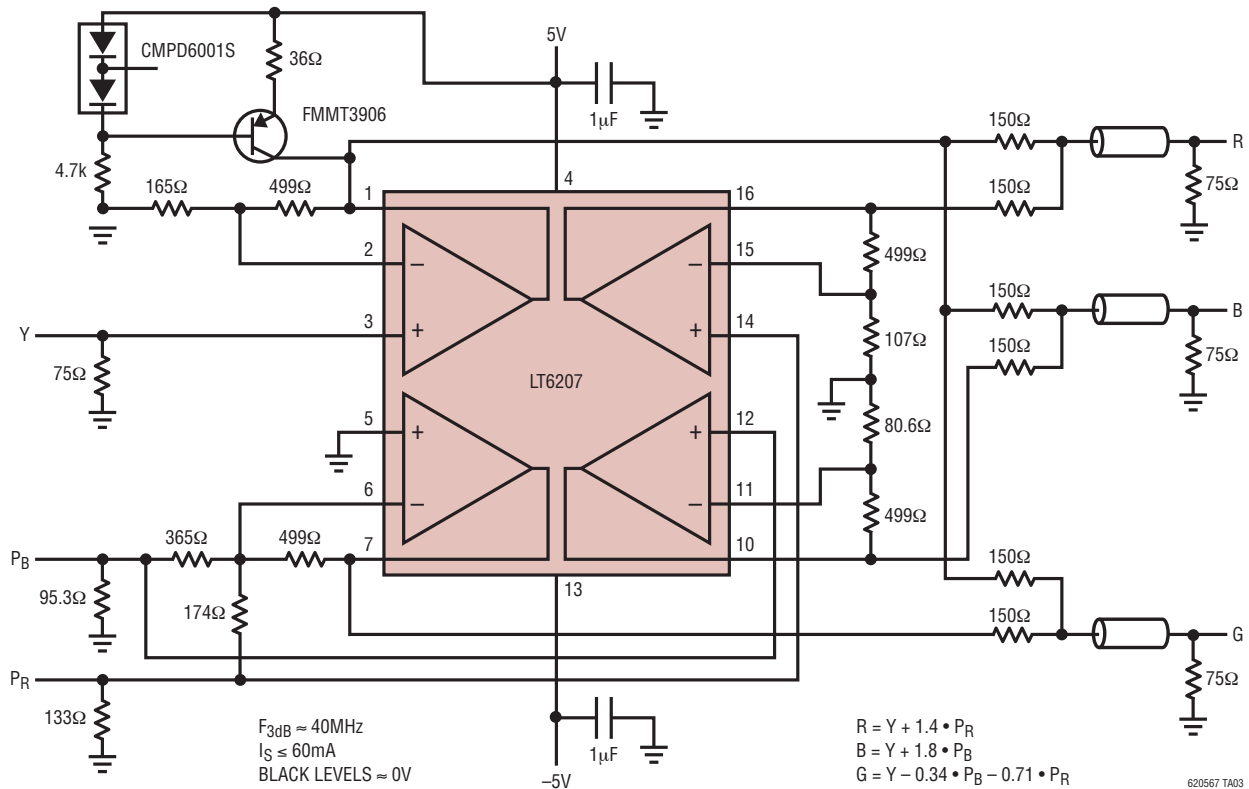

RELATED PARTS

PART NUMBER	DESCRIPTION	COMMENTS
LT1253/LT1254	Low Cost Dual and Quad Video Amplifiers	-3dB Bandwidth = 90MHz, Current Feedback
LT1395/LT1396/LT1397	Single Dual Quad 400MHz Current Feedback Amplifiers	0.1dB Flatness to 100MHz, 80mA Output Drive
LT1675	RGB Multiplexer with Current Feedback Amplifiers	-3dB Bandwidth = 250MHz, 100MHz Pixel Switching
LT1809/LT1810	Single/Dual, 180MHz, Rail-to-Rail Input and Output Amplifiers	350V/μs Slew Rate, Shutdown, Low Distortion -90dBc at 5MHz
LT6550/LT6551	3.3V Triple and Quad Video Amplifiers	Internal Gain of 2, 110MHz -3dB Bandwidth, Input Common Modes to Ground
LT6552	3.3V Single Supply Video Difference Amplifier	Differential or Single-Ended Gain Block, 600V/μs Slew Rate, Input Common Modes to Ground