

NPN General Purpose Transistors

 Lead(Pb)-Free

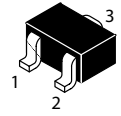
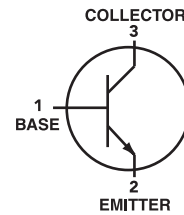

SOT-323(SC-70)

MAXIMUM RATINGS

Rating	Symbol	Value	Unit
Collector-Emitter Voltage	V_{CEO}	40	Vdc
Collector-Base Voltage	V_{CBO}	75	Vdc
Emitter-Base Voltage	V_{EBO}	6.0	Vdc
Collector Current-Continuous	I_C	600	mAdc

THERMAL CHARACTERISTICS

Characteristics	Symbol	Max	Unit
Total Device Dissipation FR-5 Board $T_A=25^\circ\text{C}$	P_D	150	mW
Thermal Resistance, Junction to Ambient	$R_{\theta JA}$	833	$^\circ\text{C/W}$
Junction and Storage, Temperature	T_J, T_{stg}	-55 to+150	$^\circ\text{C}$

DEVICE MARKING

MMBT2222AW=P1

ELECTRICAL CHARACTERISTICS

Characteristics	Symbol	Min	Max	Unit
-----------------	--------	-----	-----	------

OFF CHARACTERISTICS

Collector-Emitter Breakdown Voltage ($I_C=10\text{ mAdc}, I_B=0$) ⁽¹⁾	$V_{(BR)CEO}$	40	-	Vdc
Collector-Base Breakdown Voltage ($I_C=10\text{ }\mu\text{Adc}, I_E=0$)	$V_{(BR)CBO}$	75	-	Vdc
Emitter-Base Breakdown Voltage ($I_E=10\text{ }\mu\text{Adc}, I_C=0$)	$V_{(BR)EBO}$	6.0	-	Vdc
Collector Cutoff Current ($V_{CE}=60\text{ Vdc}, V_{EB}(\text{off})=3.0\text{ Vdc}$)	I_{CEX}	-	10	nAdc
Collector Cutoff Current ($V_{CB}=60\text{ Vdc}, I_E=0$) ($V_{CB}=60\text{ Vdc}, I_E=0, T_A=125^\circ\text{C}$)	I_{CBO}	-	0.01 10	μAdc
Emitter Cutoff Current ($V_{EB}=3.0\text{ Vdc}, I_C=0$)	I_{EBO}	-	100	nAdc
Base Cutoff Current ($V_{CE}=60\text{ Vdc}, V_{EB}(\text{off})=3.0\text{ Vdc}$)	I_{BL}	-	20	nAdc

1. Pulse Test: Pulse Width $\leq 300\mu\text{s}$, Duty Cycle $\leq 2.0\%$

ELECTRICAL CHARACTERISTICS ($T_A=25^\circ\text{C}$ unless otherwise noted) (Continued)

Characteristics	Symbol	Min	Max	Unit
-----------------	--------	-----	-----	------

ON CHARACTERISTICS⁽¹⁾

DC Current Gain ($I_C=0.1\text{ mAdc}$, $V_{CE}=10\text{ Vdc}$) ($I_C=1.0\text{ mAdc}$, $V_{CE}=10\text{ Vdc}$) ($I_C=10\text{ mAdc}$, $V_{CE}=10\text{ Vdc}$) ($I_C=150\text{ mAdc}$, $V_{CE}=10\text{ Vdc}$) ($I_C=500\text{ mAdc}$, $V_{CE}=10\text{ Vdc}$)	h_{FE}	35 50 75 100 40	- - - 300 -	-
Collector-Emitter Saturation Voltage ($I_C=150\text{ mAdc}$, $I_B=15\text{ mAdc}$) ($I_C=500\text{ mAdc}$, $I_B=50\text{ mAdc}$)	$V_{CE(sat)}$	- -	0.3 1.0	Vdc
Base-Emitter Saturation Voltage ($I_C=150\text{ mAdc}$, $I_B=15\text{ mAdc}$) ($I_C=500\text{ mAdc}$, $I_B=50\text{ mAdc}$)	$V_{BE(sat)}$	0.6 -	1.2 2.0	Vdc

SMALL-SIGNAL CHARACTERISTICS

Current-Gain-Bandwidth Product ($I_C=20\text{ mAdc}$, $V_{CE}=20\text{ Vdc}$, $f=100\text{ MHz}$)	f_T	300	-	MHz
Output Capacitance ($V_{CB}=10\text{ Vdc}$, $I_E=0$, $f=1.0\text{ MHz}$)	C_{obo}	-	8.0	pF
Input Capacitance ($V_{EB}=0.5\text{ Vdc}$, $I_C=0$, $f=1.0\text{ MHz}$)	C_{ibo}	-	25	pF
Input Impedance ($I_C=10\text{ mAdc}$, $V_{CE}=10\text{ Vdc}$, $f=1.0\text{ kHz}$)	h_{ie}	0.25	1.25	$k\Omega$
Voltage Feedback Ratio ($I_C=10\text{ mAdc}$, $V_{CE}=10\text{ Vdc}$, $f=1.0\text{ kHz}$)	h_{re}	-	4.0	$\times 10^{-4}$
Small-Signal Current Gain ($I_C=10\text{ mAdc}$, $V_{CE}=10\text{ Vdc}$, $f=1.0\text{ kHz}$)	h_{fe}	75	375	-
Output Admittance ($I_C=10\text{ mAdc}$, $V_{CE}=10\text{ Vdc}$, $f=1.0\text{ kHz}$)	h_{oe}	25	200	μmhos
Collector Base Time Constant ($I_E=20\text{ mAdc}$, $V_{CB}=20\text{ Vdc}$, $f=31.8\text{ MHz}$)	r_b, C_c	-	150	ps
Noise Figure ($I_C=100\text{ }\mu\text{A}$, $V_{CE}=10\text{ Vdc}$, $R_S=1.0k\Omega$, $f=1.0\text{ kHz}$)	NF	-	4.0	dB

ELECTRICAL CHARACTERISTICS (T_A=25 °C unless otherwise noted) (Continued)

Characteristics	Symbol	Min	Max	Unit
-----------------	--------	-----	-----	------

SWITCHING CHARACTERISTICS (MMBT2222A only)

Delay Time	(V _{CC} =30 Vdc, V _{BE} =(off)=-0.5Vdc, I _C =150 mA, I _{B1} =15 mA)	t _d	-	10	ns
Rise Time		t _r	-	25	
Storage Time	(V _{CC} =30 Vdc, I _C =150 mA, I _{B1} =I _{B2} =15 mA)	t _s	-	225	ns
Fall Time		t _f	-	60	

3. Pulse Test: Pulse Width ≤ 300 μs, Duty Cycle ≤ 2.0%.

4. f_T is defined as the frequency at which I_{hfe} extrapolates to unity.

Typical Characteristics

Typical Pulsed Current Gain vs Collector Current

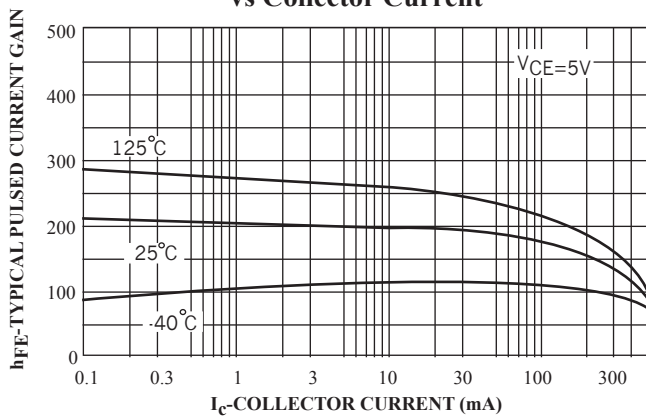

Collector-Emitter Saturation Voltage vs Collector Current

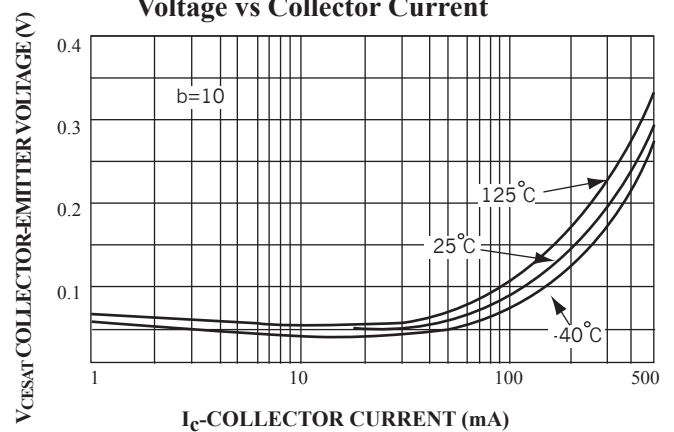

Base-Emitter Saturation Voltage vs Collector Current

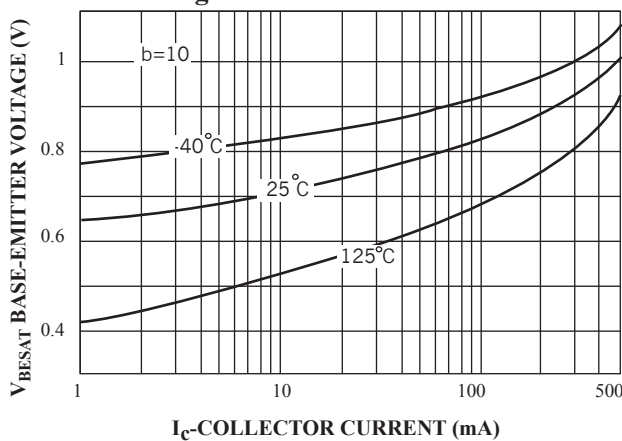

Base-Emitter ON Voltage vs Collector Current

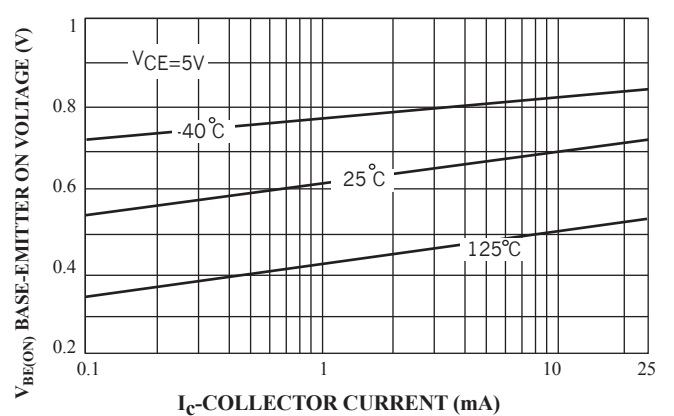

Collector-Cutoff Current vs Ambient Temperature

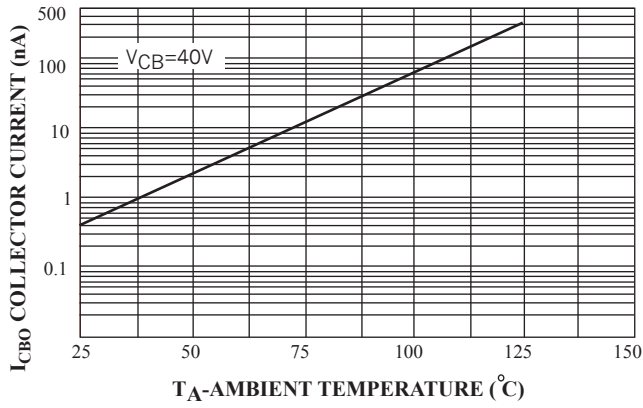

Emitter Transition and Output Capacitance vs Reverse Bias Voltage

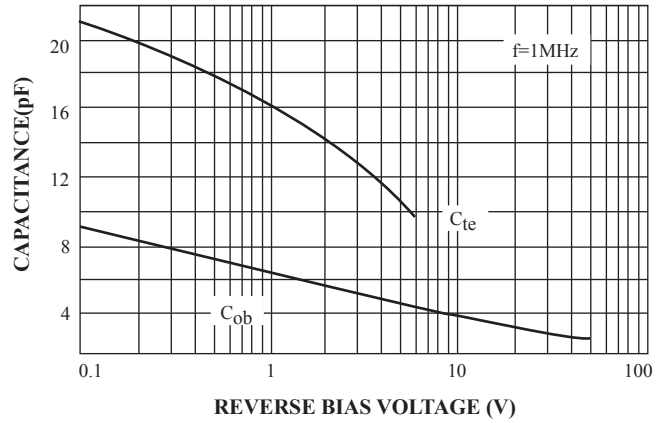

Turn On and Turn Off Times vs Collector Current

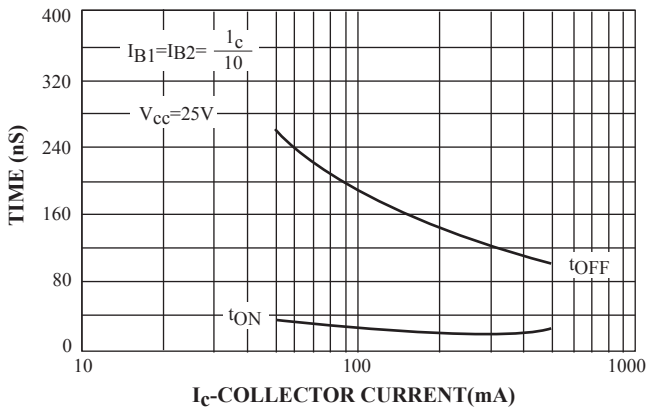

Switching Times vs Collector Current

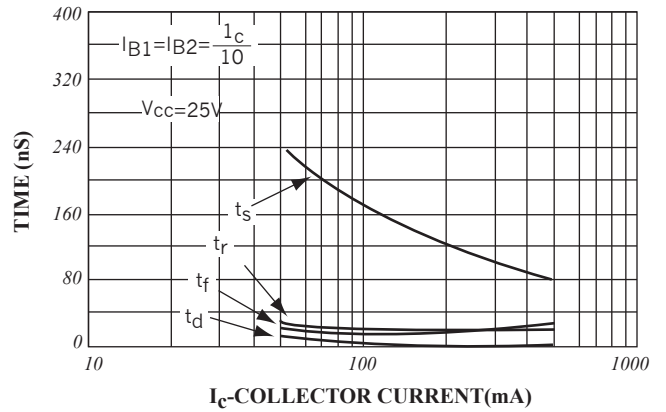

Power Dissipation vs Ambient Temperature

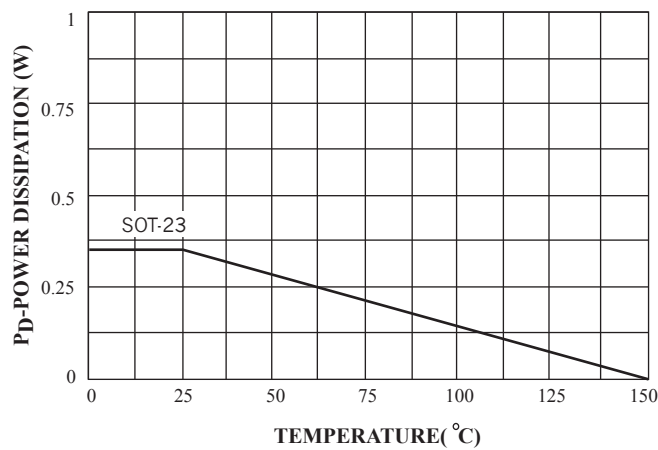

TEST CIRCUIT

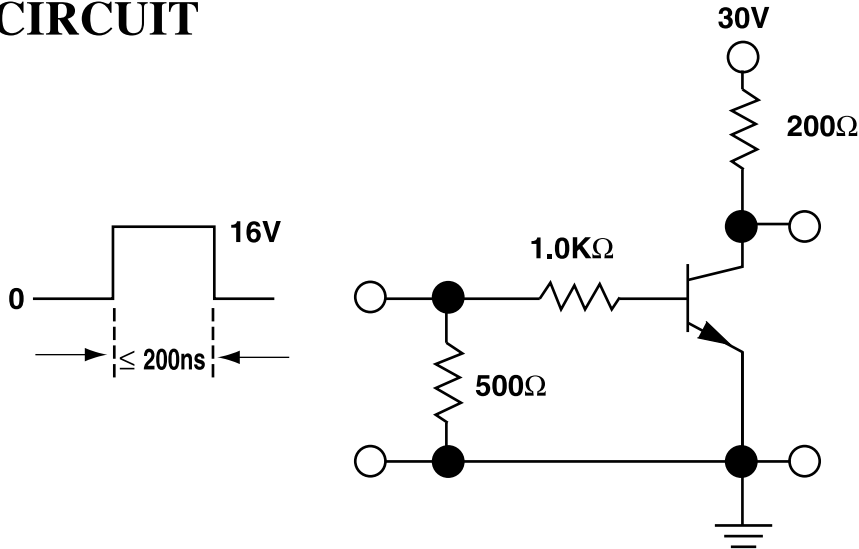

FIGURT 1: Saturated Turn-On Switching Time

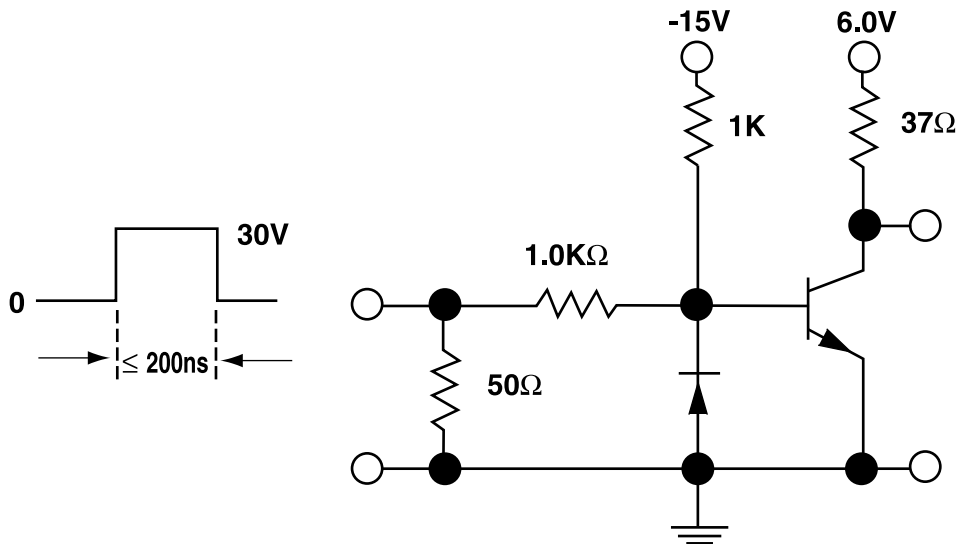

FIGURT 2: Saturated Turn-Off Switching Time

SOT-323 Outline Demensions

Unit:mm

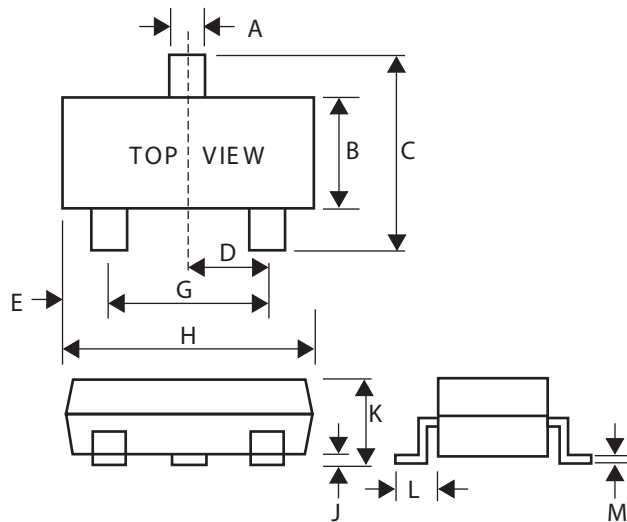

SOT-323		
Dim	Min	Max
A	0.30	0.40
B	1.15	1.35
C	2.00	2.40
D	-	0.65
E	0.30	0.40
G	1.20	1.40
H	1.80	2.20
J	0.00	0.10
K	0.80	1.00
L	0.42	0.53
M	0.10	0.25