

## 160-1579 Solder terminal, turreted, feed thru

Recommended mounting hole .204 (5,18), #6 drill

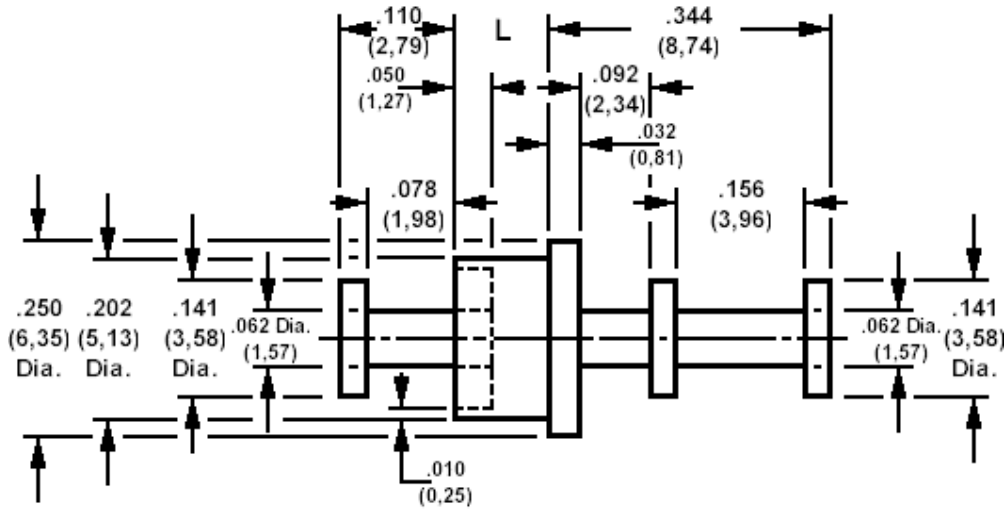

### How to order code

**160-1579-XX-YY-00**

Basic Part No XX = L dimension, YY = Plating Finish

DIMENSIONS (XX)			
Basic Part No	(XX)	L	Board Thickness
160-1579	-01	.063 (1,60)	.031 (0,79)
	-02	.094 (2,39)	.062 (1,59)
	-03	.125 (3,18)	.094 (2,38)
	-04	.156 (3,96)	.125 (3,18)

MATERIALS			
Component	Material	Finish (YY)	
Terminal	Brass	-01	-05
		Silver	Electro Solder

SWAGE TOOLING	
Recommended Swaging Tools:-	
Anvil	435-6406-01-00-00
Roll punch	435-6606-01-00-00