

SIKOREL®

Applications

- Compact design for automotive applications

Features

- 150 °C operating temperature up to 55 V
- High ripple current capability
- High vibration resistance
- Long useful life
- Miniaturized design
- Optimized CU value
- Shelf life up to 15 years

Construction

- Charge-discharge proof, polar
- Aluminum case with insulating sleeve
- Negative pole connected to case

Terminals

- Axial leads, welded to ensure perfect electrical contact
- Also available with soldering stars

Taping and packing

- Axial-lead capacitors will be delivered in pallet package.
Capacitors with $d \times l \leq 16 \times 30$ mm are also available taped on reel.
- Solder-star capacitors are packed in cardboard..

For details on taping and packing, refer to page 342.

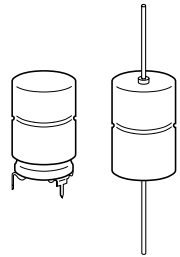

KAL0573-K

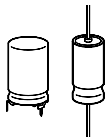
B41695 / B41795
Compact – Up to 150 °C
Specifications and characteristics in brief

Rated voltage U_R	25 ... 63 VDC					
Surge voltage U_S	$1,15 \cdot U_R$					
Rated capacitance C_R	220 ... 2 200 μF					
Capacitance tolerance	– 10/+ 30 % \triangleq Q					
Leakage current I_L (5 min, 20 °C)	$I_L \leq 0,006 \mu\text{A} \cdot \left(\frac{C_R}{\mu\text{F}} \cdot \frac{U_R}{\text{V}} \right) + 4 \mu\text{A}$					
Self-inductance $ESL^1)$	Diameter d	12 mm	14 mm	16 mm	18 mm	
	Length l	Terminal	Approx. ESL (nH)			
	25 mm	axial / solder star	— / —	22 / 6	26 / 7	— / —
	30 mm	axial / solder star	21 / 6	24 / 7	29 / 8	34 / 10
	39 mm	axial / solder star	— / —	— / —	33 / 9	38 / 11
Useful life		Requirements:				
150 °C; U_{op} ; 0,5 I_{-R}^*)	> 1 000 h	$\Delta C/C \leq \pm 30$ % of initial value				
140 °C; U_R ; I_{-R}	> 1 000 h	$ESR \leq 3$ times initial specified limit				
125 °C; U_R ; I_{-R}	> 3 000 h	$I_L \leq$ initial specified limit				
85 °C; U_R ; I_{-max}	> 8 000 h	Failure percentage: $\leq 0,5$ %				
40 °C; U_R ; 2,1 $\cdot I_{-R}$	> 200 000 h	Failure rate: ≤ 10 fit ($\leq 20 \cdot 10^{-9}/\text{h}$)				
*) U_{op} , see useful life graph, page 322		(for definition “fit”, refer to chapter “Quality”, page 62)				
Voltage endurance test	2 000 h	Post test requirements:				
125 °C; U_R		$\Delta C/C \leq \pm 10$ % of initial value				
		$ESR \leq 1,3$ % of initial specified limit				
		$I_L \leq$ initial specified limit				
Vibration resistance	To IEC 60068-2-6, test Fc: displacement amplitude 1,5 mm, at 10 Hz to 2 kHz, acceleration max. 20 g, duration 3 \times 2 h					
IEC climatic category	To IEC 60068-1: 55/125/56 (– 55 °C/+ 125 °C/56 days damp heat test)					
Detail specification	Similar to CECC 30301-802					
Sectional specification	IEC 60384-4					

1) If optimum circuit design is used, the values are lower by 30 %.

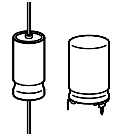

Dimensional drawings

Axial-lead capacitor

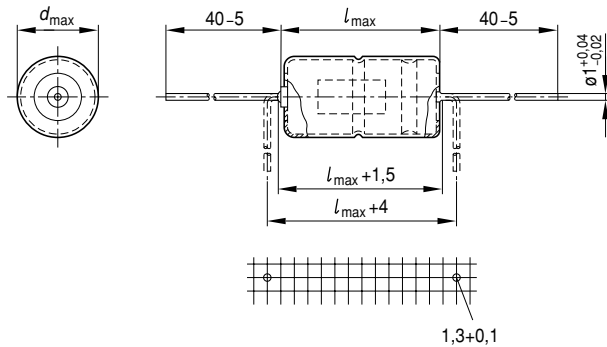

KAL0524-S

Dimensions, weights and packing units

$d \times l$ mm	$d_{\max} \times l_{\max}$ mm	Approx. weight g	Packing units (pieces)	
			Pallet	Reel
12 × 30	12,5 × 30,5	5,1	288	450
14 × 30	14,5 × 30,5	6,8	200	350
16 × 30	16,5 × 30,5	8,9	180	250
18 × 30	18,5 × 30,5	11,1	160	—
18 × 39	18,5 × 40	14,7	160	—

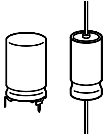

B41695 / B41795

Compact – Up to 150 °C

Soldering star capacitors

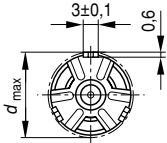

Mounting holes
 $d = 12 \text{ mm} \dots 14 \text{ mm}$

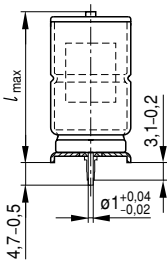
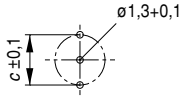

Mounting holes
 $d = 16 \text{ mm} \dots 18 \text{ mm}$

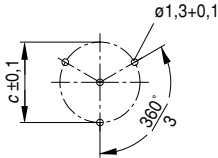

Soldering star is connected to the negative pole

KAL0525-1-E

The PC-board hole arrangement specified above is based on circular arcs.

If, however, the mounting holes have to be matched to a standard drilling raster, a spacing of 1,27 mm ($1/20''$) has proved to be sufficiently accurate if the following arrangements are used:

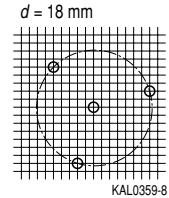
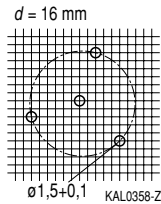
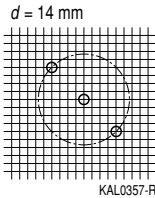
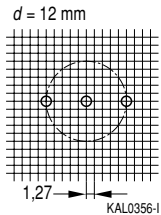

Dimensions, weights and packing units

$d \times l$ mm	$d_{\text{max}} \times l_{\text{max}}$ mm	$c \pm 0,1$ mm	Approx. weight g	Packing units pieces
12 × 30	13,5 × 32	12,5	5,4	480
14 × 30	15,5 × 32	14,5	7,2	480
16 × 30	17,5 × 32	16,5	9,4	300
18 × 30	19,5 × 32	18,5	11,8	300
18 × 39	19,5 × 41,5	18,5	15,4	200

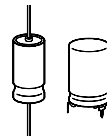
Overview of available types

U_R (VDC)	25	40	63
C_R (μ F)	Case dimensions $d \times l$ (mm)		
220			12 \times 30
470		12 \times 30	16 \times 30
680	12 \times 30		
1 000	14 \times 25	16 \times 30	18 \times 39
2 200	18 \times 30	18 \times 39	

Case dimensions and ordering codes

U_R	C_R	Case dim. $d \times l$ mm	Ordering code Axial pallet package	Axial reel	Soldering star
25	680	12 \times 30	B41695A5687Q007	B41695A5687Q009	B41795A5687Q000
	1 000	14 \times 25	B41695A5108Q007	B41695A5108Q009	B41795A5108Q000
	2 200	18 \times 30	B41695A5228Q007		B41795A5228Q000
40	470	12 \times 30	B41695A7477Q007	B41695A7477Q009	B41795A7477Q000
	1 000	16 \times 30	B41695A7108Q007	B41695A7108Q009	B41795A7108Q000
	2 200	18 \times 39	B41695A7228Q007		B41795A7228Q000
63	220	12 \times 30	B41695A8227Q007	B41695A8227Q009	B41795A8227Q000
	470	16 \times 30	B41695A8477Q007	B41695A8477Q009	B41795A8477Q000
	1 000	18 \times 39	B41695A8108Q007		B41795A8108Q000

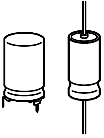

B41695 / B41795
Compact – Up to 150 °C
Technical data

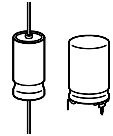
C_R	ESR_{typ}	ESR_{max}	ESR_{max}	ESR_{max}	Z_{max}	$I_{\sim max}$	$I_{\sim max}$	$I_{\sim R}$	$I_{\sim max}$
100 Hz	100 Hz	100 Hz	100 Hz	10 kHz	100 kHz	10 kHz	10 kHz	10 kHz	10 kHz
20 °C	20 °C	20 °C	-40 °C	20 °C	20 °C	40 °C	85 °C	125 °C	150 °C
μF	m Ω	m Ω	Ω	m Ω	m Ω	A	A	A	A (*)
25 VDC									
680	230	380	2,80	295	270	3,30	2,85	1,25	0,62
1 000	160	260	1,90	210	200	3,70	3,20	1,40	0,70
2 200	80	130	0,95	105	100	6,25	5,40	2,35	1,17 (*) at 20 V
40 VDC									
470	210	350	3,40	240	225	3,65	3,15	1,40	0,70
1 000	110	170	1,70	125	120	5,50	4,80	2,10	1,05
2 200	60	90	0,80	60	60	9,00	7,80	3,40	1,70 (*) at 35 V
63 VDC									
220	280	460	3,80	255	240	3,45	3,00	1,30	0,65
470	140	220	2,10	130	120	5,30	4,60	2,00	1,00
1 000	70	110	1,00	70	60	8,90	7,70	3,35	1,67 (*) at 55 V

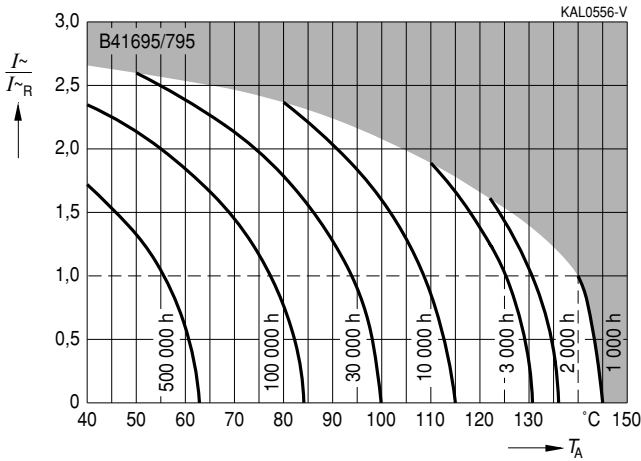

Useful life

depending on ambient temperature T_A under ripple current operating conditions at $U_R^{1)}$



Useful life

depending on case temperature T_C under ripple current operating conditions at $U_R^{1)}$

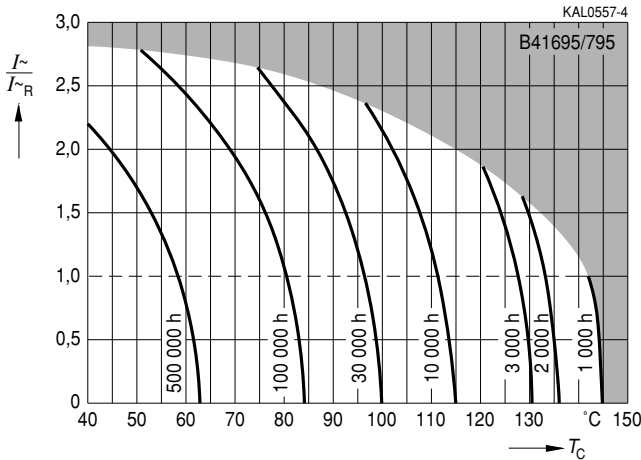

1) Refer to page 40 for an explanation on how to interpret the useful life graphs.

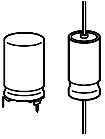

B41695 / B41795

Compact – Up to 150 °C

Useful life

depending on ambient temperature T_A under ripple current operating conditions at $U_{op}^{1)}$

$U_R = 25 \text{ V}: U_{op} \leq 20 \text{ V}$

$U_R = 40 \text{ V}: U_{op} \leq 35 \text{ V}$

$U_R = 63 \text{ V}: U_{op} \leq 55 \text{ V}$

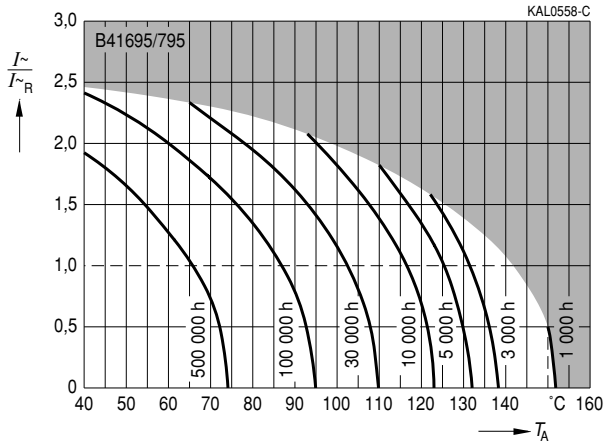

Useful life

depending on case temperature T_C under ripple current operating conditions at $U_{op}^{1)}$

$U_R = 25 \text{ V}: U_{op} \leq 20 \text{ V}$

$U_R = 40 \text{ V}: U_{op} \leq 35 \text{ V}$

$U_R = 63 \text{ V}: U_{op} \leq 55 \text{ V}$

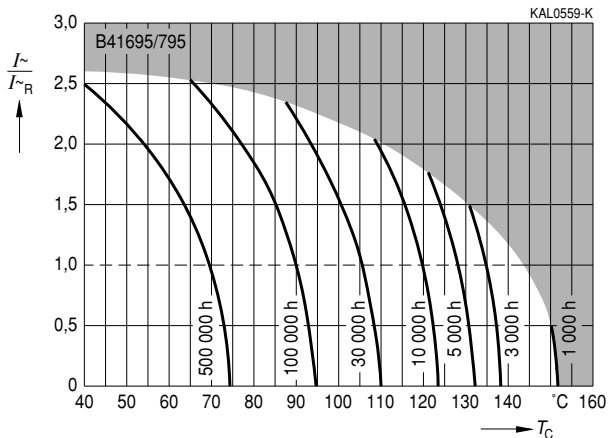

1) Refer to page 40 for an explanation on how to interpret the useful life graphs.

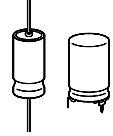

Frequency factor of permissible ripple current I_{\sim} versus frequency f

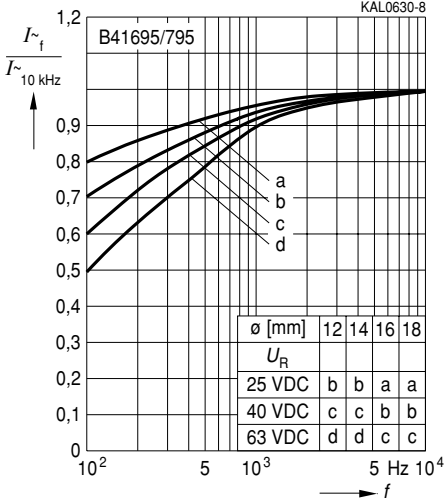

Frequency characteristics of ESR at different temperatures
Typical behavior

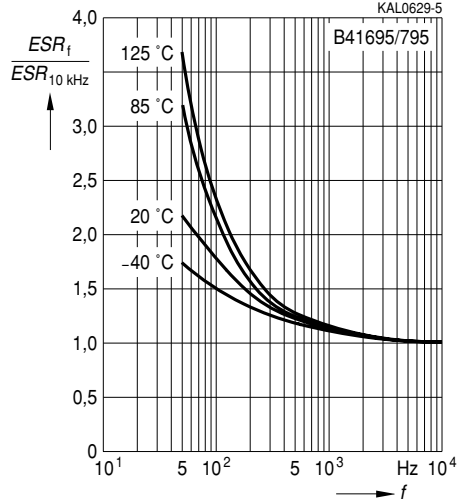

Equivalent series resistance ESR versus frequency at different temperatures
Typical behavior for 2 200 μ F/40 V

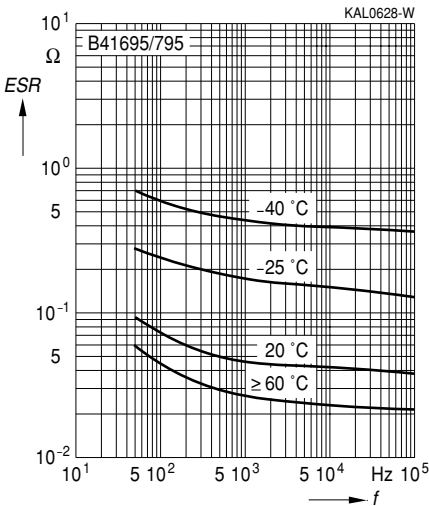

Impedance Z versus frequency f at different temperatures
Typical behavior for 2 200 μ F/40 V

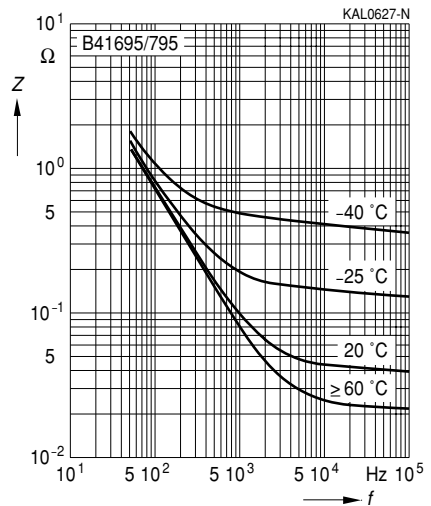

Herausgegeben von EPCOS AG

Unternehmenskommunikation, Postfach 80 17 09, 81617 München, DEUTSCHLAND

☎ ++49 89 636 09, FAX (0 89) 636-2 26 89

© EPCOS AG 2002. Vervielfältigung, Veröffentlichung, Verbreitung und Verwertung dieser Broschüre und ihres Inhalts ohne ausdrückliche Genehmigung der EPCOS AG nicht gestattet.

Bestellungen unterliegen den vom ZVEI empfohlenen Allgemeinen Lieferbedingungen für Erzeugnisse und Leistungen der Elektroindustrie, soweit nichts anderes vereinbart wird.

Diese Broschüre ersetzt die vorige Ausgabe.

Fragen über Technik, Preise und Liefermöglichkeiten richten Sie bitte an den Ihnen nächstgelegenen Vertrieb der EPCOS AG oder an unsere Vertriebsgesellschaften im Ausland. Bauelemente können aufgrund technischer Erfordernisse Gefahrstoffe enthalten. Auskünfte darüber bitten wir unter Angabe des betreffenden Typs ebenfalls über die zuständige Vertriebsgesellschaft einzuholen.

Published by EPCOS AG

Corporate Communications, P.O. Box 80 17 09, 81617 Munich, GERMANY

☎ ++49 89 636 09, FAX (0 89) 636-2 26 89

© EPCOS AG 2002. Reproduction, publication and dissemination of this brochure and the information contained therein without EPCOS' prior express consent is prohibited.

Purchase orders are subject to the General Conditions for the Supply of Products and Services of the Electrical and Electronics Industry recommended by the ZVEI (German Electrical and Electronic Manufacturers' Association), unless otherwise agreed.

This brochure replaces the previous edition.

For questions on technology, prices and delivery please contact the Sales Offices of EPCOS AG or the international Representatives.

Due to technical requirements components may contain dangerous substances. For information on the type in question please also contact one of our Sales Offices.