

Part No./型号: **130MW7C**



ATTENTION
OBSERVE PRECAUTIONS
FOR HANDLING
ELECTROSTATIC
DISCHARGE
SENSITIVE
DEVICES

Features/特性:

- Single color/单色光
- High bright output/高亮度输出
- Low power consumption/低功耗
- High reliability and long life
/可靠性高、寿命长

Descriptions/描述:

- Dice material/芯片材质: GaInN
- Emitting Color/发光颜色:
Super Bright White/高亮度白光
- Device Outline/产品外形:
Special Type/ 特殊形状
- Lens Type/胶体颜色:
Water Clear/无色透明

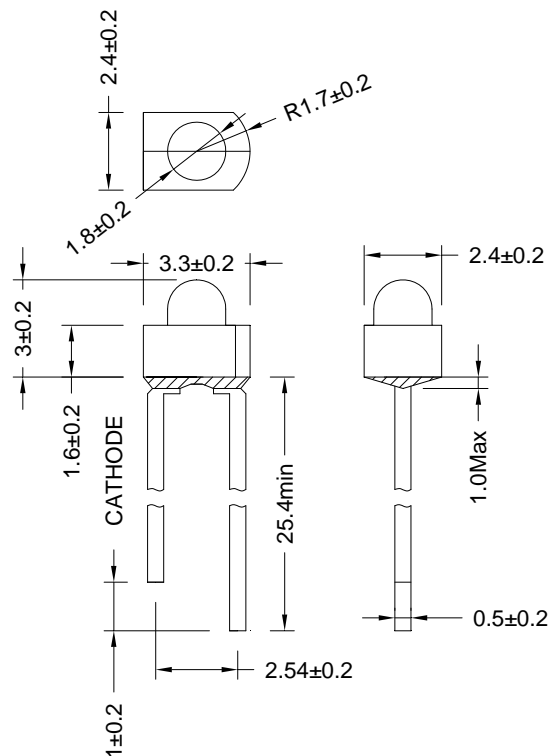

NOTE/注意:

- All dimensions are millimeters/所有尺寸单位: mm.
- Tolerance is +/-0.25mm unless otherwise noted/未标注的公差均为±0.25mm

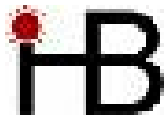
Part No./型号: **130MW7C****Absolute maximum ratings/极限参数 (Ta = 25°C)**

Parameter 参数	Symbol 符号	Test Condition 测试条件	Value 数值		Unit 单位
			Min.	Max.	
Reverse Voltage 反向电压	V _R	I _R = 30 μA	5	--	V
Forward Current 正向工作电流	I _F	----	----	25	mA
Power Dissipation 损耗功率	P _d	----	----	90	mW
Pulse Current 正向峰值电流	I _{peak}	Duty=0.1mS, 1kHz	----	100	mA
Operating Temperature 工作温度范围	T _{opr}	----	-20	+85	°C
Storage Temperature 储存温度范围	T _{str}	----	-25	+100	°C

Electrical and optical characteristics/光电参数 (Ta = 25°C)

Parameter 参数	Symbol 符号	Test Condition 测试条件	Value 数值			Unit 单位
			Min.	Typ.	Max.	
Forward Voltage 正向电压	V _F	I _F = 20mA	----	3.2	3.6	V
Reverse Current 反向电流	I _R	V _R = 5V	----	----	30	μA
Luminous Intensity 发光强度	I _V	I _F = 20mA	----	2000	----	mcd
Viewing Angle 指向角度	2 θ 1/2	I _F = 20mA	----	----	----	Deg.

Luminous Intensity Bins Chart/亮度等级 (Ta = 25°C)

Bin	S	T	U	V	W	X
Min	800	1000	1500	2000	3000	4000
Max	1000	1500	2000	3000	4000	6000

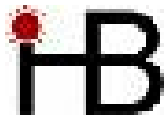

Part No./型号: **130MW7C**

Chromaticity Coordinates Ranks /色坐标等级 (IF=20mA Ta=25°C)

Wa1	X	0.243	0.215	0.230	0.263	Wa2	X	0.263	0.246	0.264	0.280
	Y	0.200	0.230	0.250	0.220		Y	0.220	0.236	0.267	0.248
Wa3	X	0.246	0.230	0.248	0.264	Wb1	X	0.280	0.264	0.283	0.296
	Y	0.236	0.250	0.286	0.267		Y	0.248	0.267	0.305	0.276
Wb2	X	0.264	0.248	0.275	0.283	Wc1	X	0.296	0.287	0.330	0.330
	Y	0.267	0.286	0.321	0.305		Y	0.276	0.295	0.339	0.318
Wc2	X	0.287	0.283	0.330	0.330	Wc3	X	0.283	0.275	0.298	0.306
	Y	0.295	0.305	0.360	0.339		Y	0.305	0.321	0.350	0.332
Wc4	X	0.306	0.298	0.321	0.330	Wd1	X	0.330	0.330	0.361	0.356
	Y	0.332	0.350	0.379	0.360		Y	0.318	0.360	0.385	0.351
Wd2	X	0.330	0.321	0.366	0.361	Wf	X	0.356	0.366	0.391	0.380
	Y	0.360	0.379	0.419	0.385		Y	0.351	0.419	0.436	0.381

CIE 1931 Chromaticity diagram/CIE1931 图

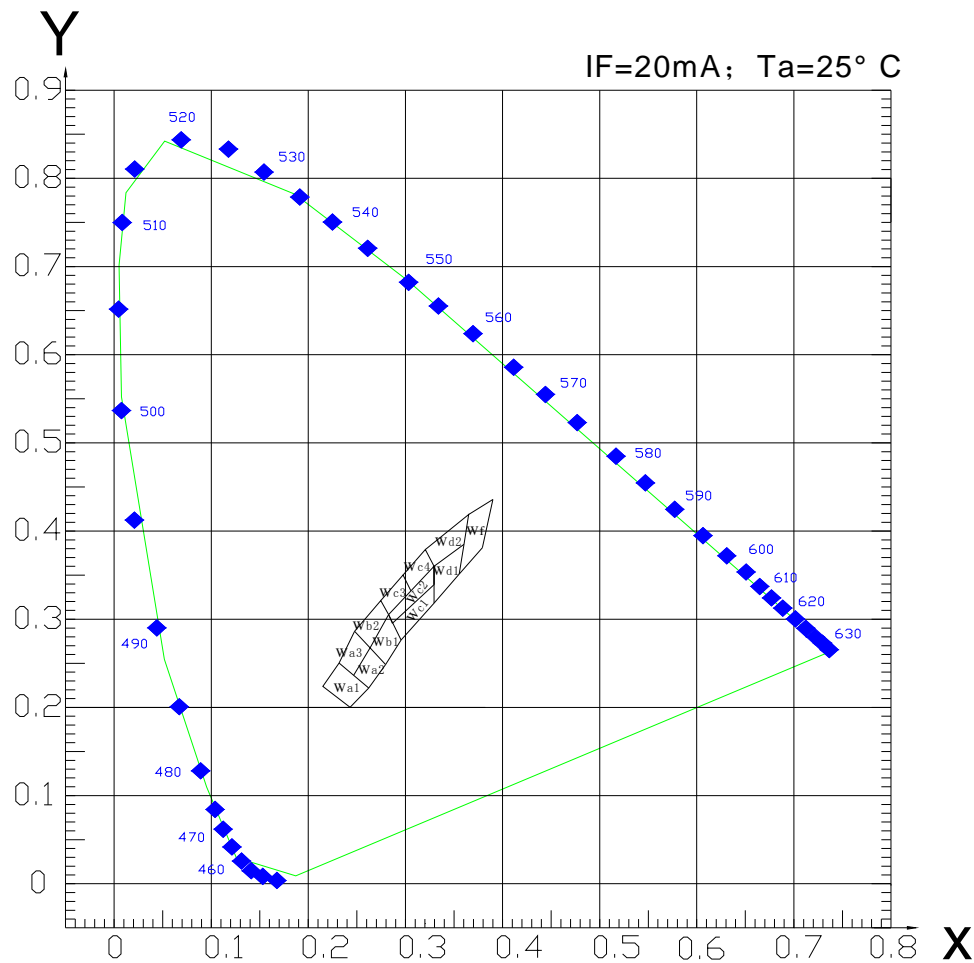

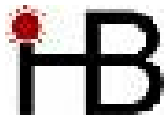

Typical electrical/optical characteristic curves/光电特性曲线:

Fig.1 正向电流 Vs. 正向电压

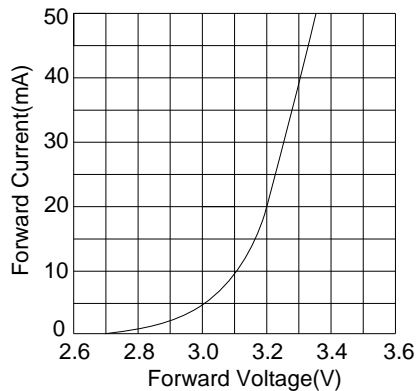

Fig.2 相对亮度 Vs. 正向电流

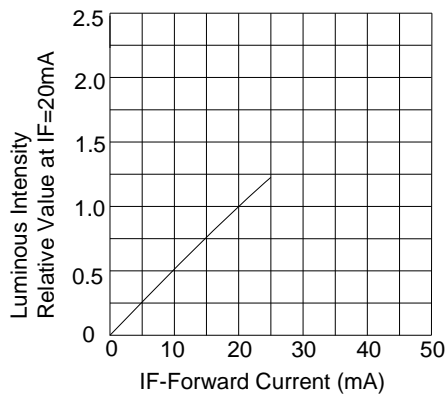

Fig.3 正向电流 Vs. 环境温度

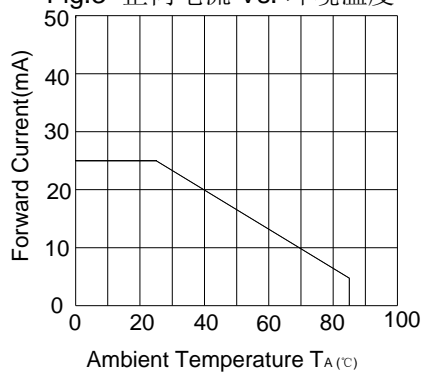

Fig.4 相对亮度 Vs. 环境温度

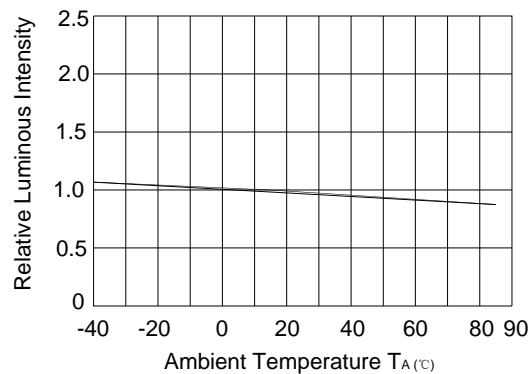
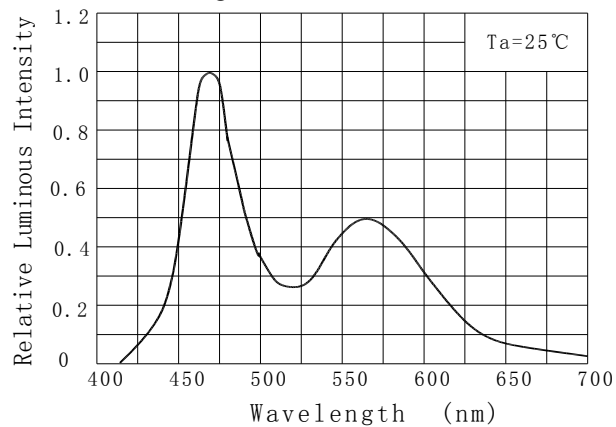

Fig.5 相对亮度 Vs 波长



FLUX BIN FOR PIRANHA (UFO) LEDS

Bin Code	LM	Bin Code	LM	Bin Code	LM	Bin Code	LM
A	<=0.46	E	1.0-1.3	J	2.8-3.6	N	7.8-10.0
B	0.46-0.60	F	1.3-1.7	K	3.6-4.7	P	10-13
C	0.60-0.77	G	1.7-2.2	L	4.7-6.0	Q	13-17
D	0.77-1.0	H	2.2-2.8	M	6.0-7.8	R	17-22

FOR WHITE COLOR BINS SEE PAGE 3B

Placing of white color BINS on CIE table

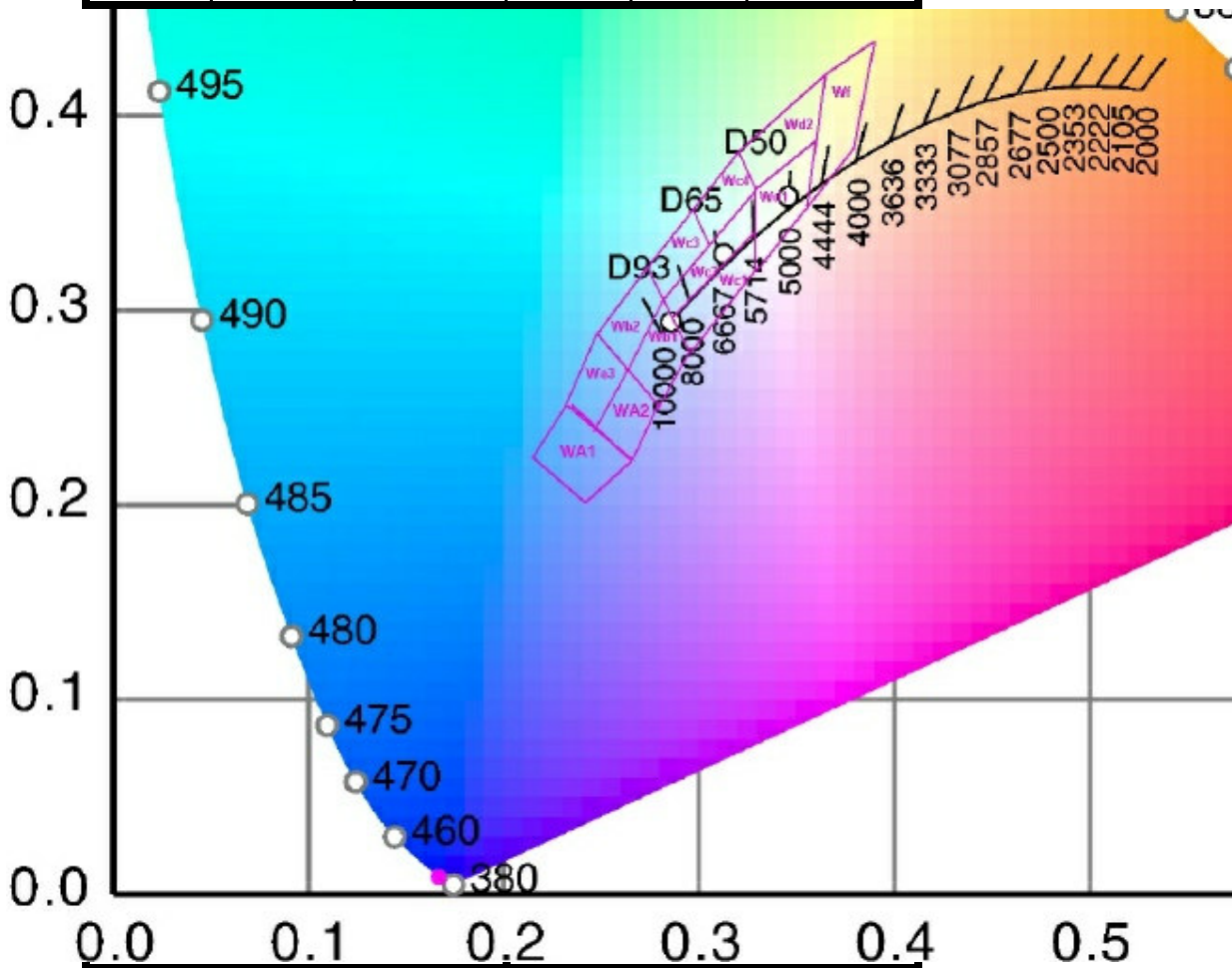

FORWARD VOLTAGE (VF) BIN

Bin Code	VF (V)	Bin Code	VF (V)	Bin Code	VF (V)	Bin Code	VF (V)
V1	1.6-1.8	V5	2.4-2.6	V9	3.2-3.4	V13	4.0-4.2
V2	1.8-2.0	V6	2.6-2.8	V10	3.4-3.6	V14	4.2-4.4
V3	2.0-2.2	V7	2.8-3.0	V11	3.6-3.8	V15	4.4-4.6
V4	2.2-2.4	V8	3.0-3.2	V12	3.8-4.0	V16	4.6-4.8