

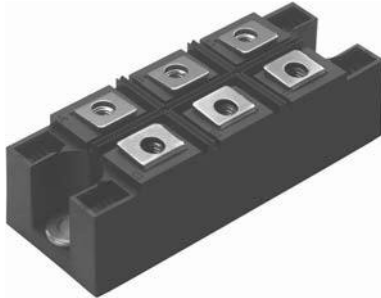

Three Phase Bridge (Power Modules), 90/110 A



MTK

FEATURES

- Package fully compatible with the industry standard INT-A-PAK power modules series
- High thermal conductivity package, electrically insulated case
- Excellent power volume ratio, outline for easy connections to power transistor and IGBT modules
- 4000 V_{RMS} isolating voltage
- UL E78996 approved 
- Totally lead (Pb)-free
- Designed and qualified for industrial level

**RoHS
COMPLIANT**

PRODUCT SUMMARY

I_o	90/110 A
-------	----------

DESCRIPTION

A range of extremely compact, encapsulated three phase bridge rectifiers offering efficient and reliable operation. They are intended for use in general purpose and heavy duty applications.

MAJOR RATINGS AND CHARACTERISTICS

SYMBOL	CHARACTERISTICS	90MT.K	110MT.K	UNITS
I_o		90 (120)	110 (150)	A
	T_c	90 (61)	90 (57)	°C
I_{FSM}	50 Hz	770	950	A
	60 Hz	810	1000	
I^2t	50 Hz	3000	4500	A ² s
	60 Hz	2700	4100	
$I^2\sqrt{t}$		30 000	45 000	A ² √s
V_{RRM}	Range	800 to 1600		V
T_{Stg}	Range	- 40 to 150		°C
T_J				

ELECTRICAL SPECIFICATIONS

VOLTAGE RATINGS

TYPE NUMBER	VOLTAGE CODE	V_{RRM} , MAXIMUM REPETITIVE PEAK REVERSE VOLTAGE V	V_{RSM} , MAXIMUM NON-REPETITIVE PEAK REVERSE VOLTAGE V	I_{RRM} MAXIMUM AT $T_J =$ MAXIMUM mA
90-110MT..K	80	800	900	10
	100	1000	1100	
	120	1200	1300	
	140	1400	1500	
	160	1600	1700	

FORWARD CONDUCTION							
PARAMETER	SYMBOL	TEST CONDITIONS		90MT.K	110MT.K	UNITS	
Maximum DC output current at case temperature	I_o	120° rect. conduction angle		90 (120)	110 (150)	A	
				90 (61)	90 (57)	°C	
Maximum peak, one-cycle forward, non-repetitive surge current	I_{FSM}	t = 10 ms	No voltage reappplied	Initial $T_J = T_J$ maximum	770	950	A
		t = 8.3 ms			810	1000	
		t = 10 ms	100 % V_{RRM} reappplied		650	800	
		t = 8.3 ms			680	840	
Maximum I^2t for fusing	I^2t	t = 10 ms	No voltage reappplied	Initial $T_J = T_J$ maximum	3000	4500	A^2s
		t = 8.3 ms			2700	4100	
		t = 10 ms	100 % V_{RRM} reappplied		2100	3200	
		t = 8.3 ms			1900	2900	
Maximum $I^2\sqrt{t}$ for fusing	$I^2\sqrt{t}$	t = 0.1 to 10 ms, no voltage reappplied		30 000	45 000	$A^2\sqrt{s}$	
Low level value of threshold voltage	$V_{F(TO)1}$	$(16.7\% \times \pi \times I_{F(AV)} < I < \pi \times I_{F(AV)})$, T_J maximum		0.89	0.81	V	
High level value of threshold voltage	$V_{F(TO)2}$	$(I > \pi \times I_{F(AV)})$, T_J maximum		1.05	0.99		
Low level value of forward slope resistance	r_{f1}	$(16.7\% \times \pi \times I_{F(AV)} < I < \pi \times I_{F(AV)})$, T_J maximum		5.11	4.37	$m\Omega$	
High level value of forward slope resistance	r_{f2}	$(I > \pi \times I_{F(AV)})$, T_J maximum		4.64			
Maximum forward voltage drop	V_{FM}	$I_{pk} = 150$ A, $T_J = 25$ °C $t_p = 400$ μs single junction		1.6	1.4	V	
RMS isolation voltage	V_{ISOL}	$T_J = 25$ °C, all terminal shorted f = 50 Hz, t = 1 s		4000			

THERMAL AND MECHANICAL SPECIFICATIONS						
PARAMETER	SYMBOL	TEST CONDITIONS		90MT.K	110MT.K	UNITS
Maximum junction operating and storage temperature range	T_J, T_{Stg}			- 40 to 150		°C
Maximum thermal resistance, junction to case	R_{thJC}	DC operation per module		0.21	0.18	$^{\circ}C/W$
		DC operation per junction		1.26	1.07	
		120° rect. conduction angle per module		0.25	0.21	
		120° rect. conduction angle per junction		1.47	1.25	
Maximum thermal resistance, case to heatsink per module	R_{thCS}	Mounting surface smooth, flat and greased		0.03		
Mounting torque ± 10 %	to heatsink to terminal	A mounting compound is recommended and the torque should be rechecked after a period of 3 hours to allow for the spread of the compound. Lubricated threads.		4 to 6		Nm
				3 to 4		
Approximate weight				176		g

Three Phase Bridge (Power Modules), 90/110 A

Vishay High Power Products

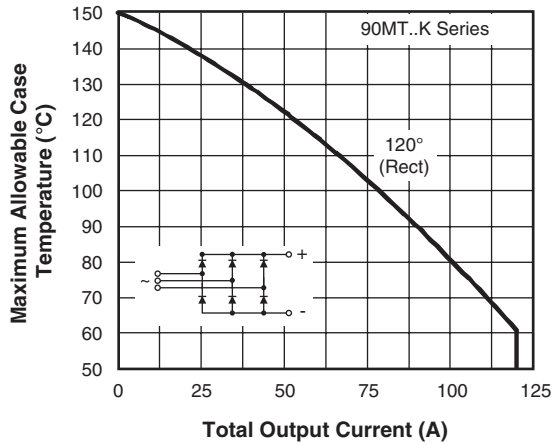

Fig. 1 - Current Ratings Characteristics

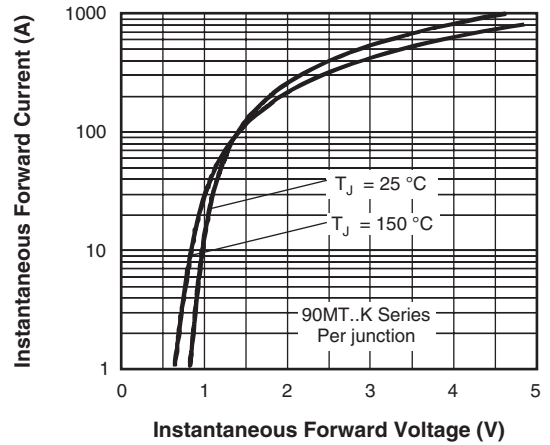

Fig. 2 - Forward Voltage Drop Characteristics

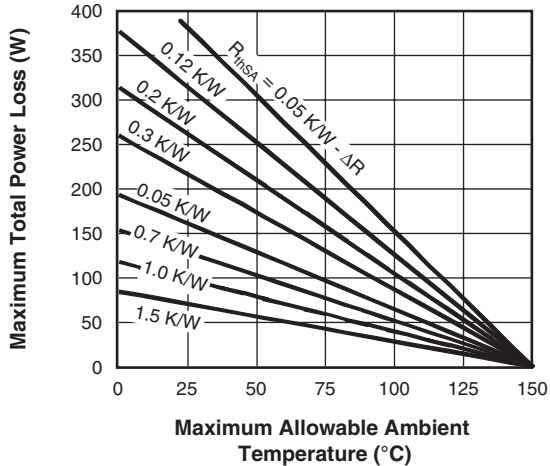
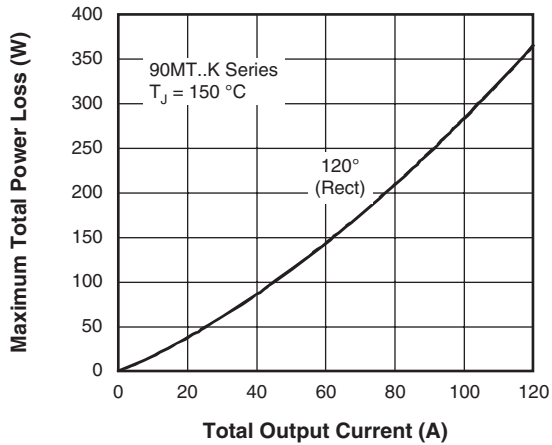

Fig. 3 - Total Power Loss Characteristics

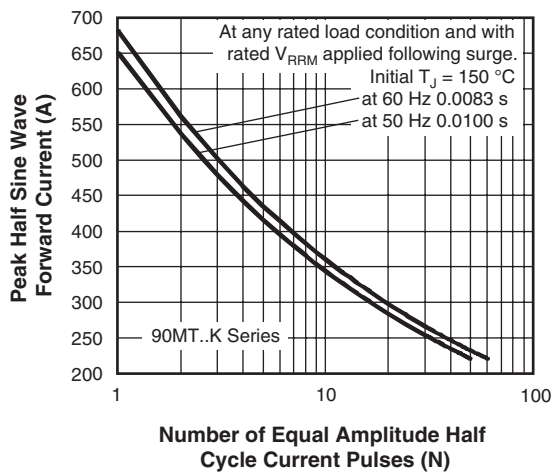

Fig. 4 - Maximum Non-Repetitive Surge Current

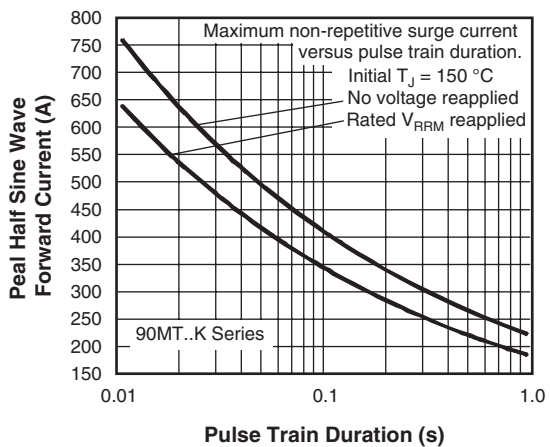

Fig. 5 - Maximum Non-Repetitive Surge Current

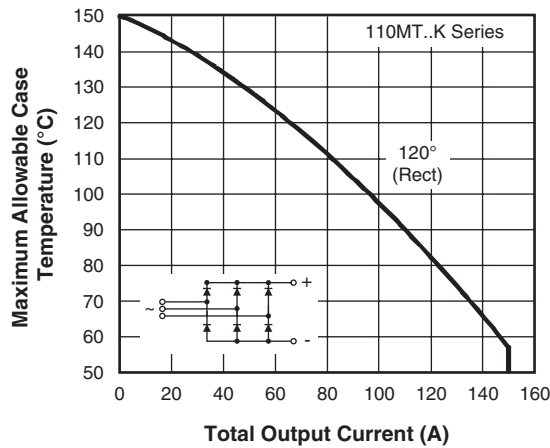

Fig. 6 - Current Ratings Characteristics

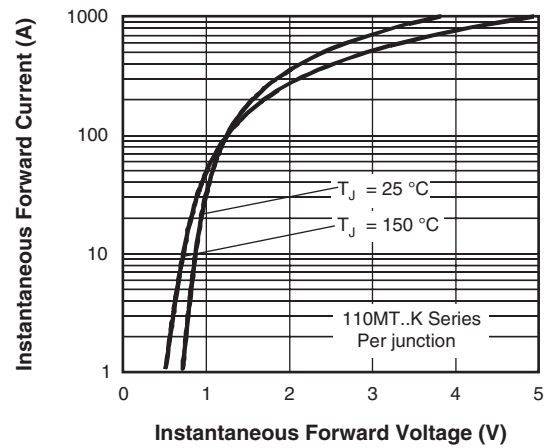

Fig. 7 - Forward Voltage Drop Characteristics

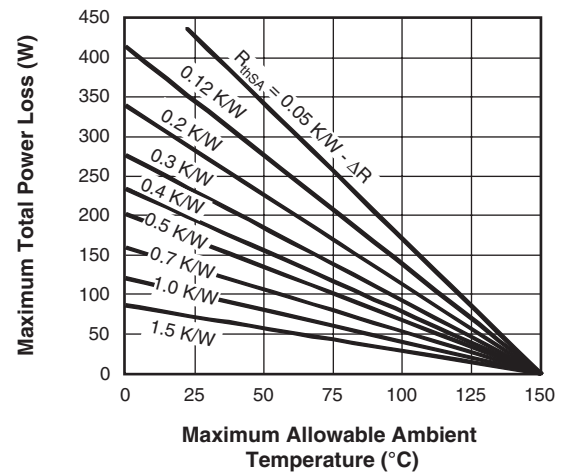
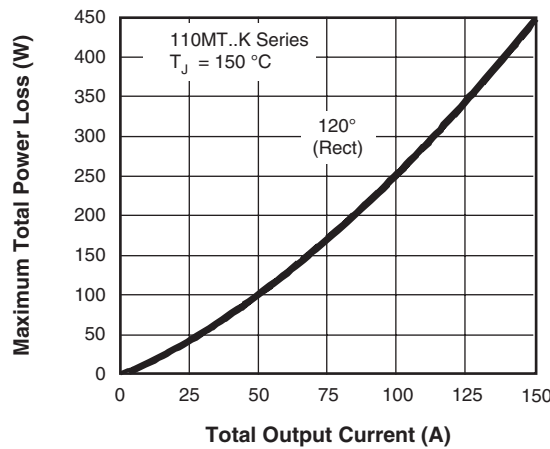

Fig. 8 - Total Power Loss Characteristics

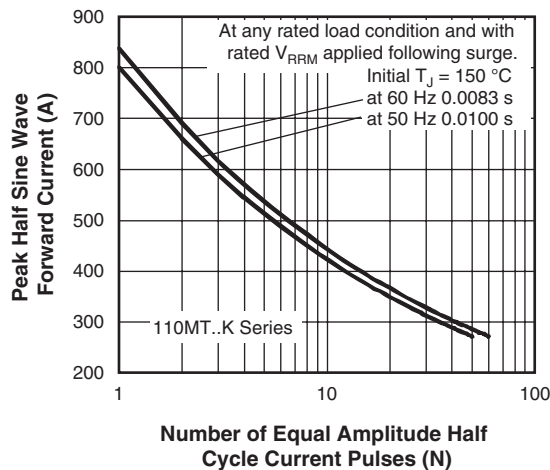

Fig. 9 - Maximum Non-Repetitive Surge Current

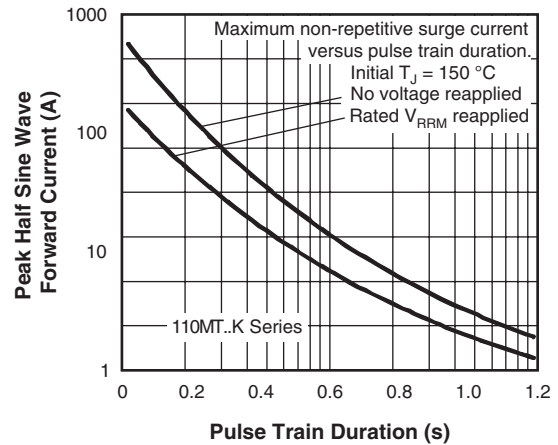

Fig. 10 - Maximum Non-Repetitive Surge Current

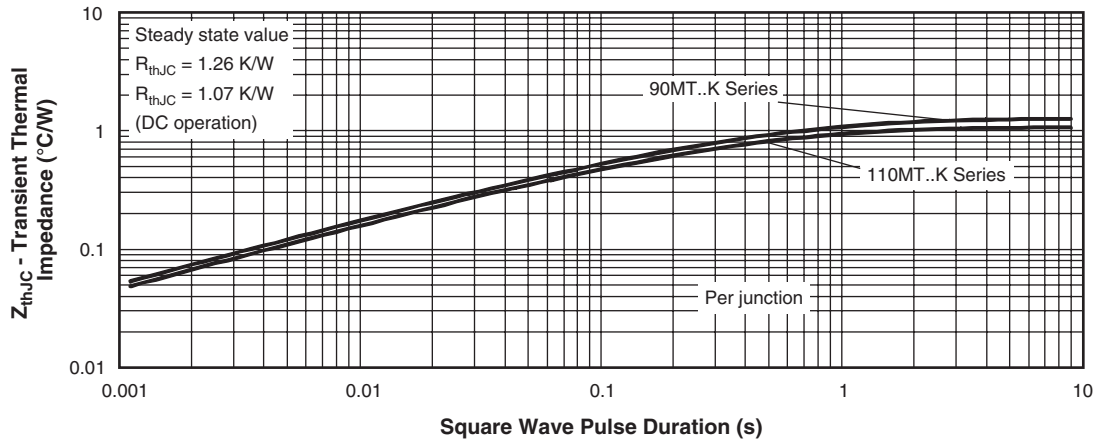

Fig. 11 - Thermal Impedance Z_{thJC} Characteristic

ORDERING INFORMATION TABLE

Device code	11	0	MT	160	K	PbF
	①	②	③	④		⑤

- 1** - Current rating code: 9 = 90 A (average)
11 = 110 A (average)
- 2** - Three phase diodes bridge
- 3** - Essential part number
- 4** - Voltage code x 10 = V_{RRM} (see Voltage Ratings table)
- 5** - PbF = Lead (Pb)-free

Note

- To order the optional hardware go to www.vishay.com/doc?95172

CIRCUIT CONFIGURATION

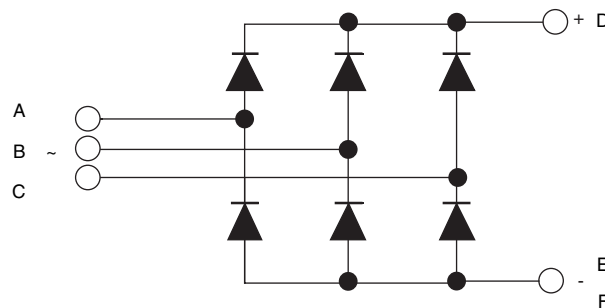

LINKS TO RELATED DOCUMENTS

Dimensions and pin out positions

<http://www.vishay.com/doc?95004>



Disclaimer

All product specifications and data are subject to change without notice.

Vishay Intertechnology, Inc., its affiliates, agents, and employees, and all persons acting on its or their behalf (collectively, "Vishay"), disclaim any and all liability for any errors, inaccuracies or incompleteness contained herein or in any other disclosure relating to any product.

Vishay disclaims any and all liability arising out of the use or application of any product described herein or of any information provided herein to the maximum extent permitted by law. The product specifications do not expand or otherwise modify Vishay's terms and conditions of purchase, including but not limited to the warranty expressed therein, which apply to these products.

No license, express or implied, by estoppel or otherwise, to any intellectual property rights is granted by this document or by any conduct of Vishay.

The products shown herein are not designed for use in medical, life-saving, or life-sustaining applications unless otherwise expressly indicated. Customers using or selling Vishay products not expressly indicated for use in such applications do so entirely at their own risk and agree to fully indemnify Vishay for any damages arising or resulting from such use or sale. Please contact authorized Vishay personnel to obtain written terms and conditions regarding products designed for such applications.

Product names and markings noted herein may be trademarks of their respective owners.