

Three Phase Rectifier Bridge

$I_{dAVM} = 25 \text{ A}$
 $V_{RRM} = 1200-1800 \text{ V}$

V_{RSM} V	V_{RRM} V	Type
600	600	VUO 25-06NO8
1200	1200	VUO 25-12NO8
1400	1400	VUO 25-14NO8
1600	1600	VUO 25-16NO8
1800	1800	VUO 25-18NO8

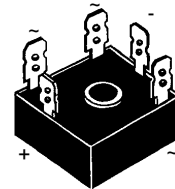
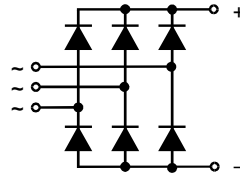

Symbol	Test Conditions	Maximum Ratings	Features	
I_{dAV} I_{dAVM}	$T_C = 85^\circ\text{C}$, module $T_C = 63^\circ\text{C}$, module	20 25	A A	
I_{FSM}	$T_{VJ} = 45^\circ\text{C}$; $V_R = 0$	$t = 10 \text{ ms}$ (50 Hz), sine $t = 8.3 \text{ ms}$ (60 Hz), sine	380 400	A A
	$T_{VJ} = T_{VJM}$ $V_R = 0$	$t = 10 \text{ ms}$ (50 Hz), sine $t = 8.3 \text{ ms}$ (60 Hz), sine	360 400	A A
I^2t	$T_{VJ} = 45^\circ\text{C}$ $V_R = 0$	$t = 10 \text{ ms}$ (50 Hz), sine $t = 8.3 \text{ ms}$ (60 Hz), sine	725 750	A^2s A^2s
	$T_{VJ} = T_{VJM}$ $V_R = 0$	$t = 10 \text{ ms}$ (50 Hz), sine $t = 8.3 \text{ ms}$ (60 Hz), sine	650 650	A^2s A^2s
T_{VJ} T_{VJM} T_{sig}			-40...+150 150 -40...+150	$^\circ\text{C}$ $^\circ\text{C}$ $^\circ\text{C}$
V_{ISOL}	50/60 Hz, RMS $I_{ISOL} \leq 1 \text{ mA}$	$t = 1 \text{ min}$ $t = 1 \text{ s}$	2500 3000	V~ V~
M_d	Mounting torque (M5) (10-32 UNF)		$2 \pm 10 \%$ $18 \pm 10 \%$	Nm lb.in.
Weight	typ.		22	g

Features

- Package with 1/4" fast-on terminals
- Isolation voltage 3000 V~
- Planar passivated chips
- Blocking voltage up to 1800 V
- Low forward voltage drop
- UL registered E 72873

Applications

- Supplies for DC power equipment
- Input rectifiers for PWM inverter
- Battery DC power supplies
- Field supply for DC motors

Advantages

- Easy to mount with one screw
- Space and weight savings
- Improved temperature and power cycling

Symbol	Test Conditions	Characteristic Values	
I_R	$T_{VJ} = 25^\circ\text{C}$; $T_{VJ} = T_{VJM}$	$V_R = V_{RRM}$ $V_R = V_{RRM}$	$\leq 0.3 \text{ mA}$ $\leq 5.0 \text{ mA}$
V_F	$I_F = 150 \text{ A}$; $T_{VJ} = 25^\circ\text{C}$		$\leq 2.2 \text{ V}$
V_{T0}	For power-loss calculations only		0.85 V
r_T			12 mΩ
R_{thJC}	per diode; DC current per module		9.3 K/W 1.55 K/W
R_{thJH}	per diode; DC current per module		10.2 K/W 1.7 K/W
d_S	Creeping distance on surface		12.7 mm
d_A	Creepage distance in air		9.4 mm
a	Max. allowable acceleration		50 m/s ²

Data according to DIN IEC 60747 and refer to a single diode unless otherwise stated.
 IXYS reserves the right to change limits, test conditions and dimensions.

Dimensions in mm (1 mm = 0.0394")

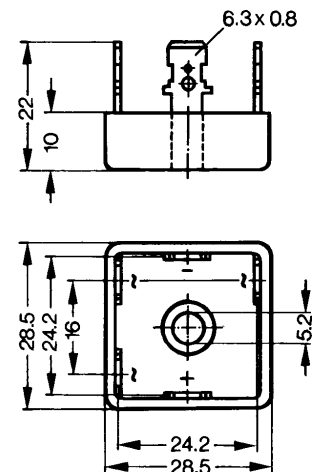

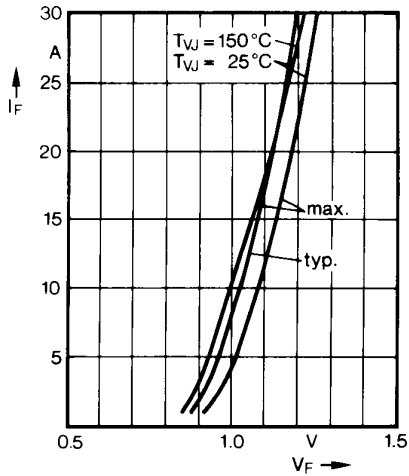

Fig. 1 Forward current versus voltage drop per diode

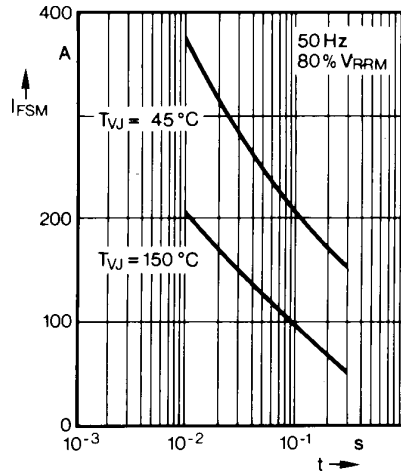

Fig. 2 Surge overload current per diode
 I_{FSM} : Crest value. t : duration

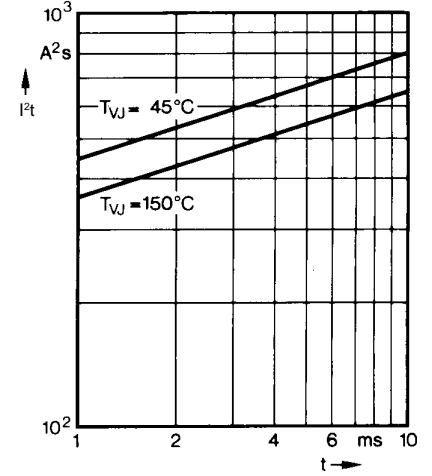

Fig. 3 I^2t versus time (1-10 ms) per diode

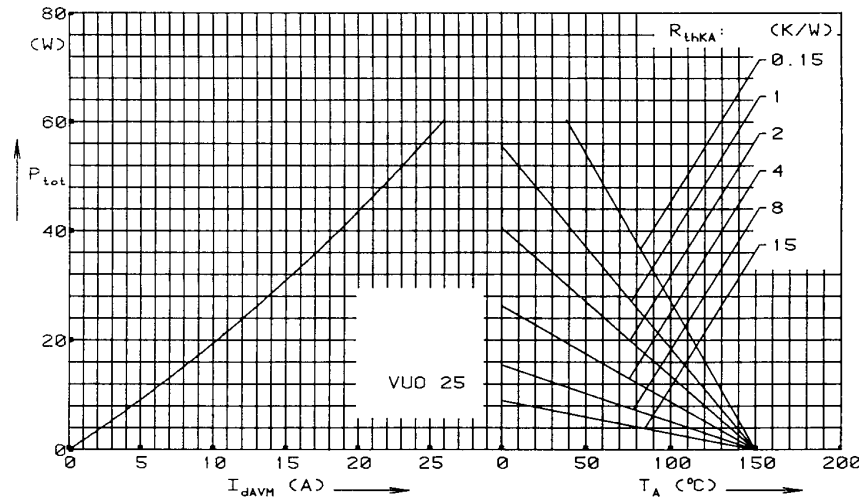

Fig. 4 Power dissipation versus direct output current and ambient temperature

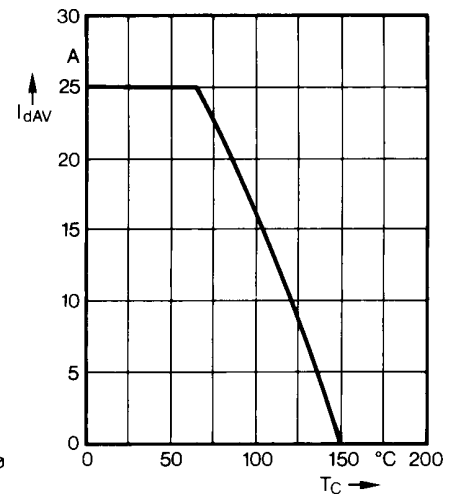

Fig. 5 Maximum forward current at case temperature

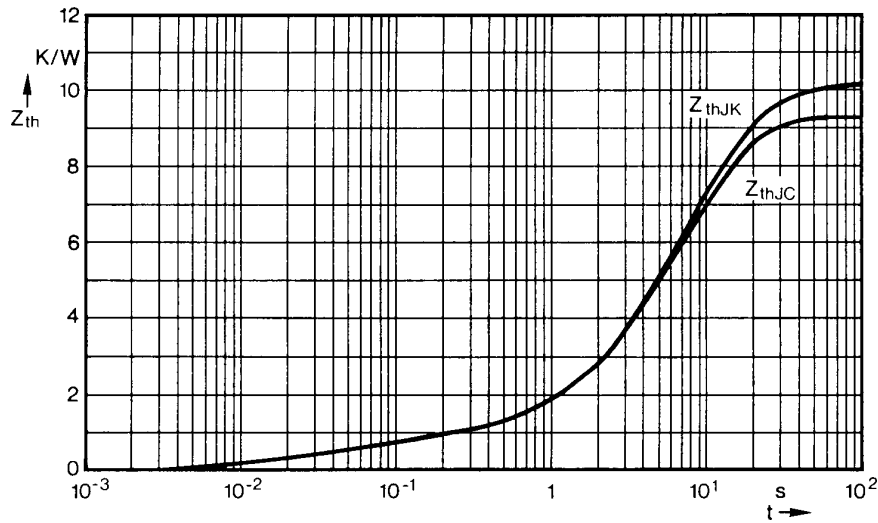

Fig. 6 Transient thermal impedance per diode

Constants for Z_{thJC} calculation:

i	R_{thi} (K/W)	t_i (s)
1	0.194	0.024
2	0.556	0.07
3	2.25	5.8
4	6.3	8.5

Constants for Z_{thJK} calculation:

i	R_{thi} (K/W)	t_i (s)
1	0.194	0.024
2	0.556	0.07
3	2.25	5.8
4	6.3	8.5
5	0.9	28.0