



Technical Data Sheet

Infrared Remote-control Receiver Module

IRM-H1xx/TR2 SERIES

Features

- High shielding against electric field disturbance.
- Low voltage and low power consumption.
- Very small sizes.
- External dimensions 7.40(L)*5.50(W)*2.55(H) mm.
- High immunity against ambient light.
- Photodiode with integrated circuit.
- TTL and CMOS compatibility.
- High sensitivity.
- Top-received SMD.
- Suitable burst length ≥ 10 pulses/burst.
- RoHS refer to IRM-Vxxx,Hxxx series SGS report
- Pb free.



Descriptions

The device is a miniature SMD type infrared remote control system receiver that has been developed and designed by utilizing the most updated IC technology. The PIN diode and preamplifier are assembled on PCB, the epoxy package is designed as an IR filter. The demodulated output signal can directly be decoded by a microprocessor.

Applications

1. Optical switch
2. Light detecting portion of remote control
 - AV instruments such as Audio, TV, VCR, CD, MD, etc.
 - Home appliances such as Air-conditioner, Fan , etc.
 - The other equipments with wireless remote control.
 - CATV set top boxes
 - Multi-media Equipment

Device Selection Guide

PART	MATERIAL	COLOR
Chip	Silicon	---
Package	Epoxy	Black
Metal case	SPCC	Silver white

IRM-H1xx/TR2 SERIES

Package Dimensions

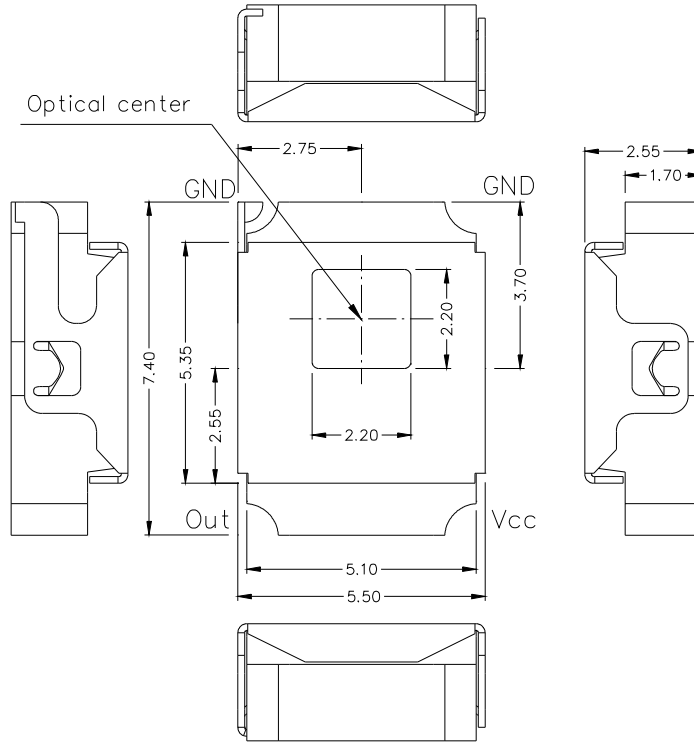

- Notes :** 1.All dimensions are in millimeters.
2.Tolerances unless dimensions $\pm 0.2\text{mm}$.

Soldering patterns

The following soldering patterns are recommended for reflow-soldering :

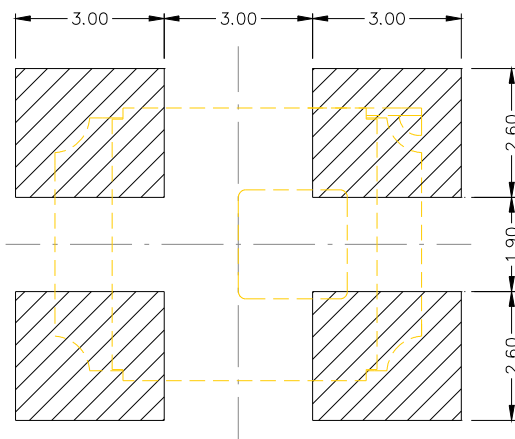

View Back

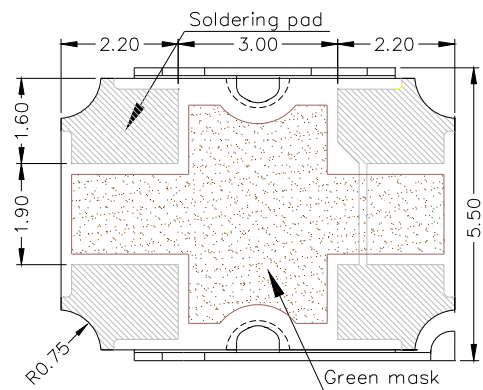

IRM-H1xx/TR2 SERIES
Available Types For Different Carrier Frequencies

Type	Carrier Frequencies (Typ)
IRM-H136/TR2	36 kHz
IRM-H138/TR2	38 kHz
IRM-H140/TR2	40 kHz

Absolute Maximum Ratings (Ta=25°C)

Parameter	Symbol	Rating	Unit	Notice
Supply Voltage	V _{cc}	6	V	
Operating Temperature	T _{opr}	-25 ~ +85	°C	
Storage Temperature	T _{stg}	-25 ~ +85	°C	

Recommended Operating Condition

Supply Voltage Rating: V_{cc} 2.7V to 5.5V

Electro-Optical Characteristics (Ta=25°C , V_{cc} = 3V)

Parameter	Symbol	MIN.	TYP.	MAX.	Unit	Condition
Supply Current	I _{cc}	---	---	3	mA	No signal input
Peak Wavelength	λ_p	---	940	---	nm	---
Reception Distance	L ₀	8	---	---	m	---
	L ₄₅	5	---	---		
Half Angle(Horizontal)	Θ_h	---	45	---	deg	At the ray axis *1
Half Angle(Vertical)	Θ_v	---	45	---	deg	
High Level Pulse Width	T _H	400	---	800	μs	At the ray axis *2
Low Level Pulse Width	T _L	400	---	800	μs	
High Level Output Voltage	V _H	2.7	---	---	V	
Low Level Output Voltage	V _L	---	0.2	0.5	V	

Notes:

*1 : The ray receiving surface at a vertex and relation to the ray axis in the range of $\theta=0^\circ$ and $\theta=45^\circ$.

*2 : A range from 30cm to the arrival distance. Average value of 50 pulses.

IRM-H1xx/TR2 SERIES

The Notice of Application:

Transmission remote control signal consist of four parts: Encode Part, IR Transmitter Source, IRM device, Decode Part

1. When IRM-H1xx code select frequency, it need to well understand the center system of encode part.
2. Strong or weak light of IR Transmitter can affect distance of transmission.
3. Minimum Burst Length T_{burst} (number of pulses per burst) : 10 cycles
4. It needs to ensure the translation range of decode part if it is applied to the pulse-width range.

If the above items hardly assure of its application, it'll cause NG(no good) message from the edge of signal.

Test Method :

The specified electro-optical characteristics is satisfied under the following Conditions at the controllable distance.

①Measurement place

A place that is nothing of extreme light reflected in the room.

②External light

Project the light of ordinary white fluorescent lamps which are not high Frequency lamps and must be less then 10 Lux at the module surface.

($E_e \leq 10\text{Lux}$)

③Standard transmitter

A transmitter whose output is so adjusted as to **$V_o=400\text{mVp-p}$** and the output Wave form shown in Fig.-1.According to the measurement method shown in Fig.-2 the standard transmitter is specified.

However , the infrared photodiode to be used for the transmitter should be $\lambda_p=940\text{nm}, \Delta\lambda=50\text{nm}$. Also, photodiode is used of PD438B($V_r=5\text{V}$).

(Standard light / Light source temperature 2856°K).

④Measuring system

According to the measuring system shown in Fig.-3

Fig.-1 Transmitter Wave Form

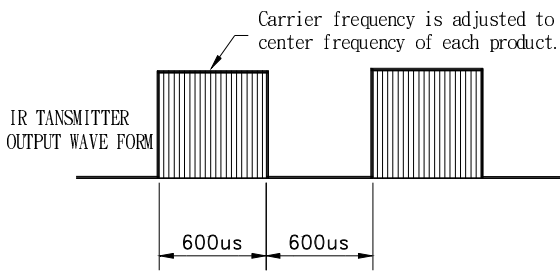

D.U.T output Pulse

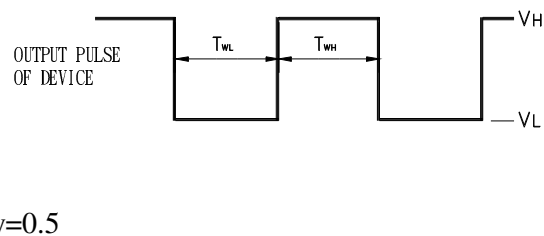

IRM-H1xx/TR2 SERIES

Fig.-2 Measuring Method

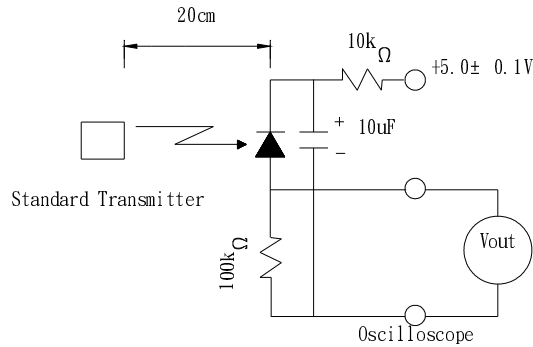
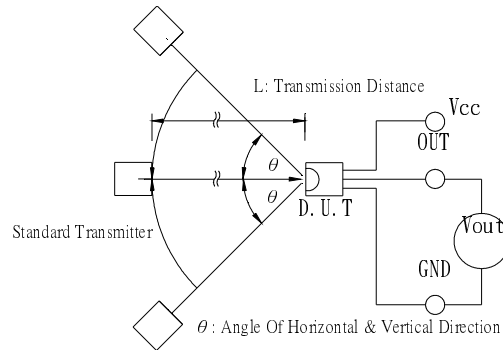
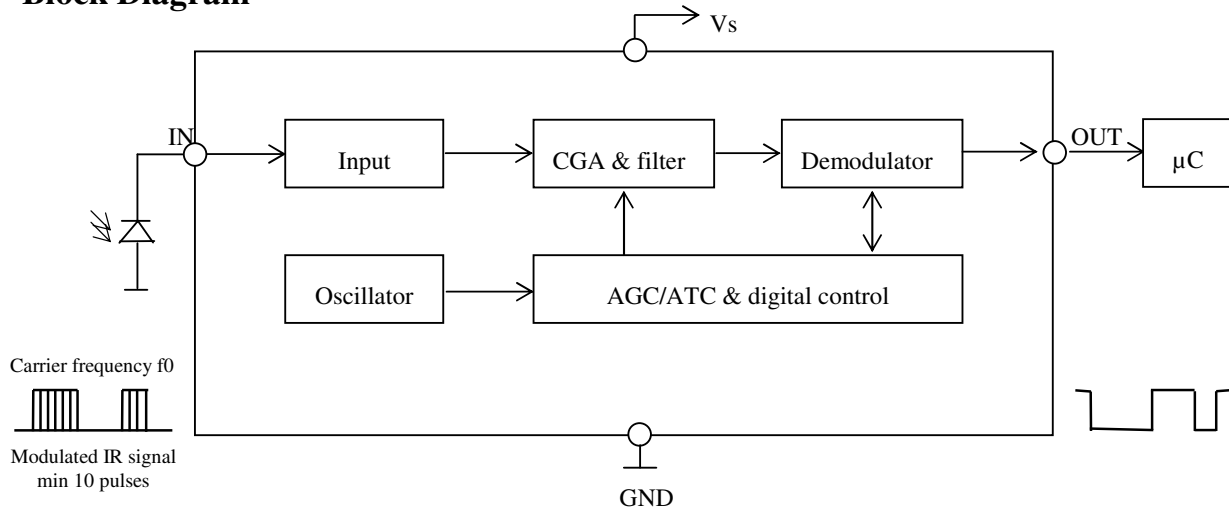

Fig.-3 Measuring System



Block Diagram :



Application Circuit :

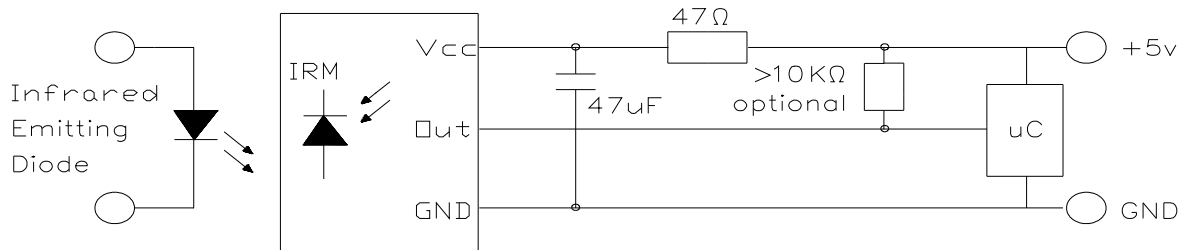

RC Filter should be connected closely between Vcc pin and GND pin.

IRM-H1xx/TR2 SERIES

Typical Electro-Optical Characteristics Curves

Fig.-4 Relative Spectral Sensitivity vs. Wavelength

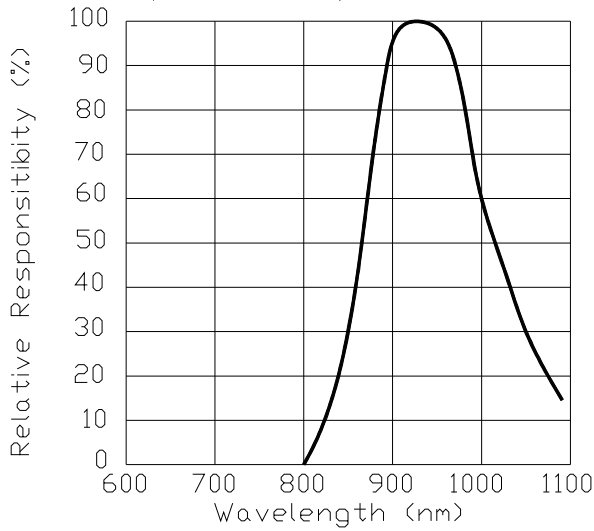

Fig.-5 Relative Transmission Distance vs. Direction

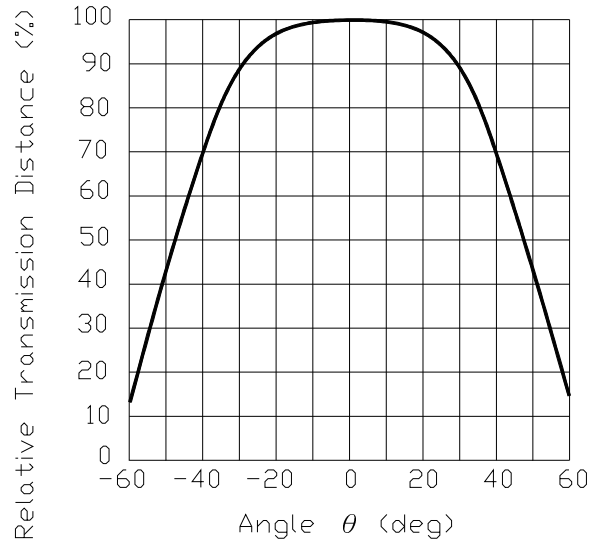

Fig.-6 Output Pulse Length vs. Arrival Distance

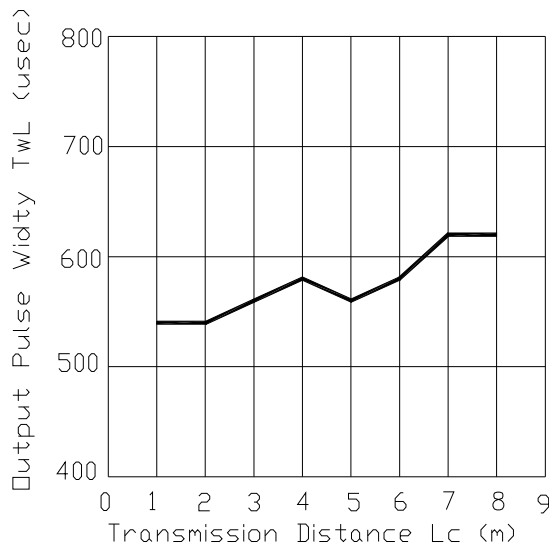
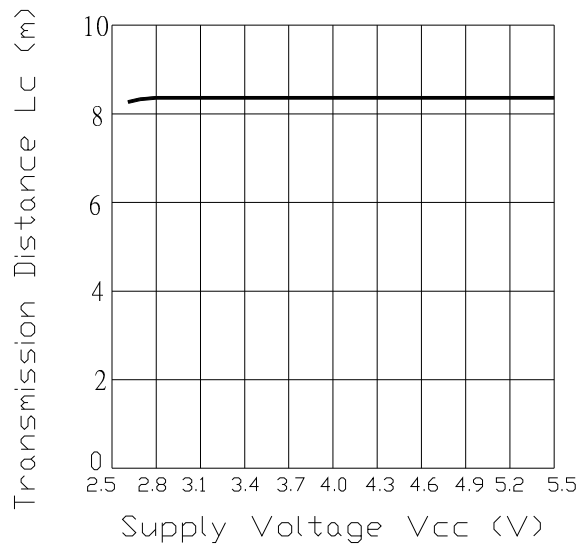

Fig.-7 Arrival Distance vs. Supply Voltage



IRM-H1xx/TR2 SERIES

Typical Electro-Optical Characteristics Curves

Fig.-8 Arrival Distance vs. Ambient Temperature Fig.-9 Relative Transmission Distance vs. Center Carrier Frequency

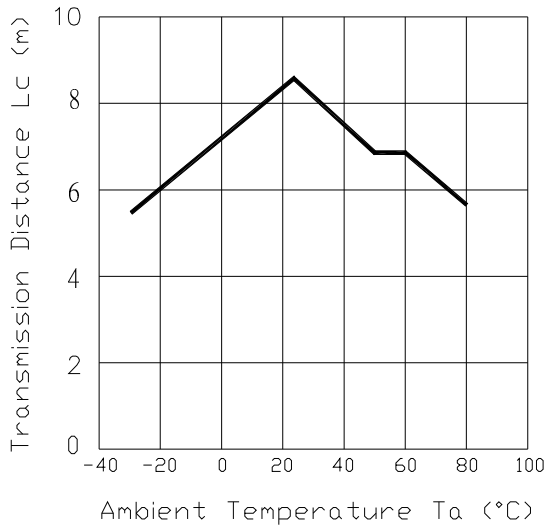

IRM-H136/TR2

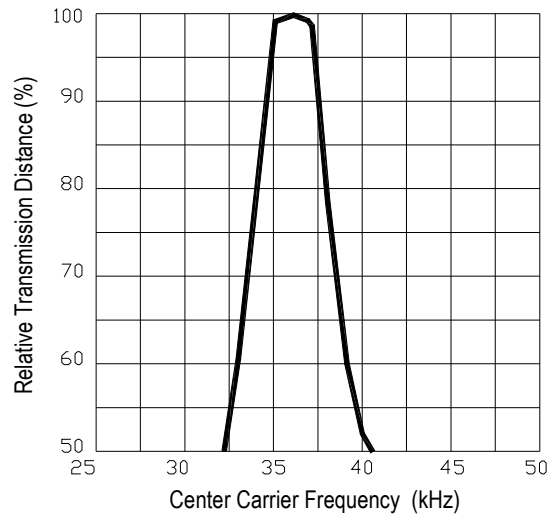
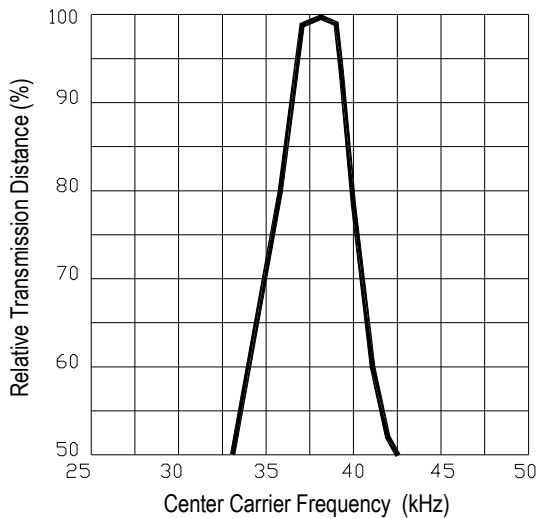
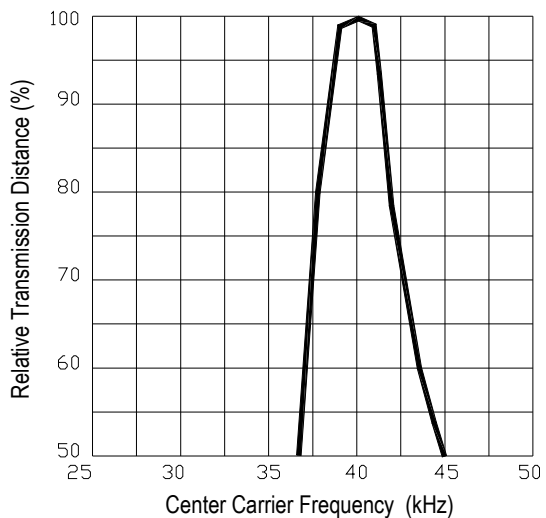

Fig.-9 Relative Transmission Distance vs. Center Carrier Frequency

IRM-H138/TR2



IRM-H140/TR2





IRM-H1xx/TR2 SERIES

Reliability Test Item And Condition

The reliability of products shall be satisfied with items listed below.

Confidence level : 90%

LTPD : 10%

Reflow Terms: JEDEC Level 4 Specification

Drying; Temp.:125°C 24hrs → Moisture 30°C / 60% RH 96hrs → Reflow Temp.: 260°C±5°C

10sec, 3 times

Note:

1. Not sooner than 15 minutes and not longer than 4 hours after removal from the temperature/humidity chamber.
2. The time between reflow shall be 5 minutes minimum and 60 minutes maximum.

Test Items	Test Conditions	Failure Judgement Criteria	Samples(n) Defective(c)
Temperature cycle	1 cycle : -25°C ↔ +85°C (30min)(5min)(30min) 300 cycle test	$L_0 \leq L \times 0.8$ $L_{45} \leq L \times 0.8$	n=76,c=0
High temperature test	Temp : +85°C Vcc : 5V 1000hrs	L: Lower specification limit	n=76,c=0
Low temperature storage	Temp : -40°C 1000hrs	*Icc : Operate Current (mA)	n=76,c=0
High temperature High humidity	Ta : 85°C , RH : 85% 1000hrs	Variation $\leq \pm 20\%$:	n=76,c=0

IRM-H1xx/TR2 SERIES

Recommended method of storage

Due to the SMD IRM is moisture sensitive device, it must pay attention to moisture protection during storage and operation procedure. Dry box storage is recommended as soon as the aluminum bag has been opened prevent moisture absorption. The following conditions should be observed, if dry boxes are not available:

1. Shelf life in sealed bag: 24 months at 10°C to 30°C and $\leq 60\%$ relative humidity (RH).
2. After this bag is opened, devices that will be subjected to infrared reflow, vapor-phase reflow, or equivalent processing(peak package body temp.260°C), must be:
 - (a) mounted within 48 hours at factory conditions of < 30°C/60% RH.
 - (b) stored per J-STD-033.
3. Devices require baking, before mounting, if humidity Indicator Card reads > 30% when read at 23°C±5°C.
4. If baking is required, refer to IPC/JEDEC J-STD-033 for bake procedure.
 - 192 hours at 40°C+5°C/-0°C and 5%RH (dry air / nitrogen) or
 - 96 hours at 60°C+5°C and < 5%RH for all device containers or
 - 24 hours at 125°C+5°C not suitable for reel or tubes.

Recommended Solder Profile

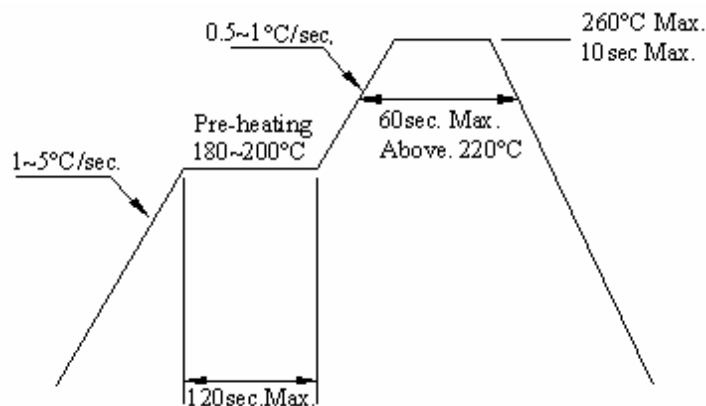

Notice:

- (1) Reflow soldering should not be done more than two times.
- (2) When soldering, do not put stress on the IRM-V038/TR1 Series devices during heating.
- (3) After soldering, do not warp the circuit board.

Soldering Iron

Each terminal is to go to the tip of soldering iron temperature less than 280°C for 3 seconds within once in less than the soldering iron capacity 25W. Leave two seconds and more intervals, and do soldering of each terminal. Be careful because the damage of the product is often started at the time of the hand solder.

Repairing

Repair should not be done after the LEDs have been soldered. When repairing is unavoidable, a double-head soldering iron should be used (as below figure). It should be confirmed beforehand whether the characteristics of the LEDs will or will not be damaged by repairing.

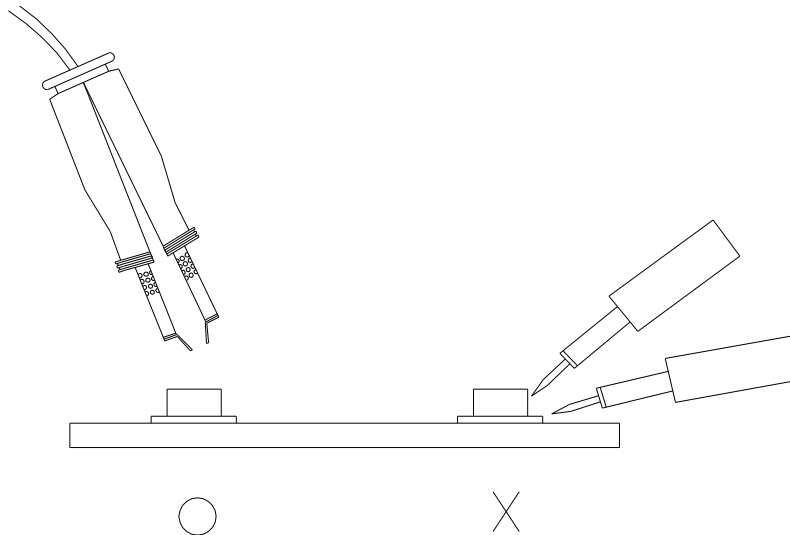

ESD Precaution

Proper storage and handing procedures should be followed to prevent ESD damage to the devices especially when they are removed from the Anti-static bag. Electro-Static Sensitive Devices warning labels are on the packing.

IRM-H1xx/TR2 SERIES

Carrier Tape Dimensions: Loaded quantity 1500 PCS per reel

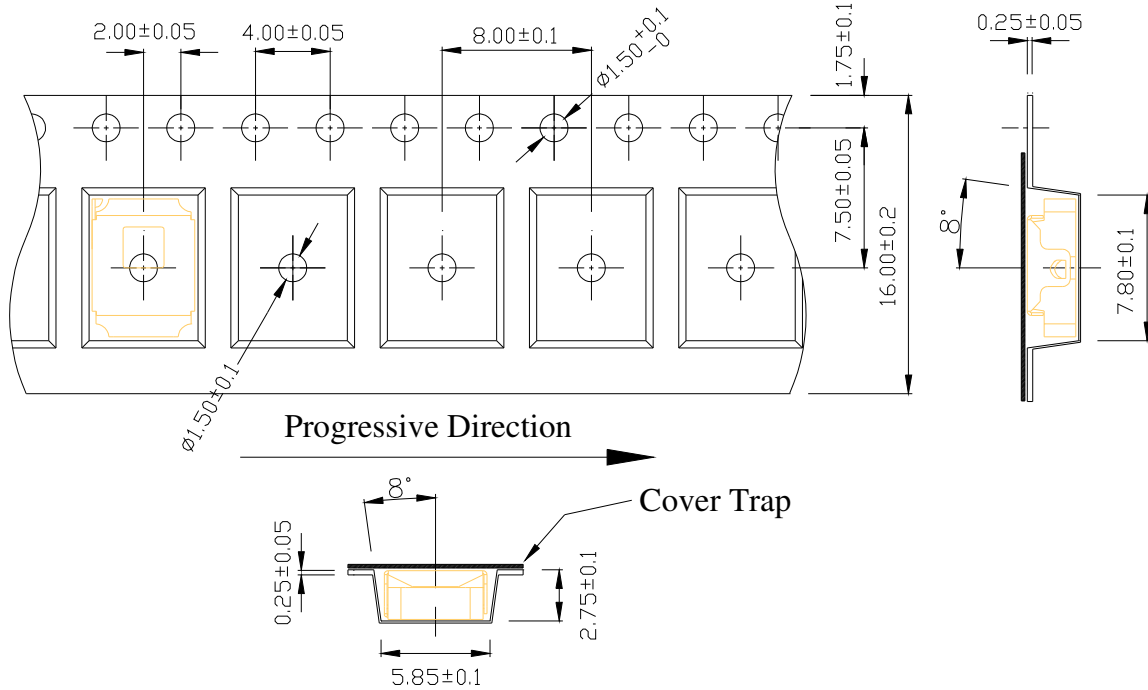

Packing process

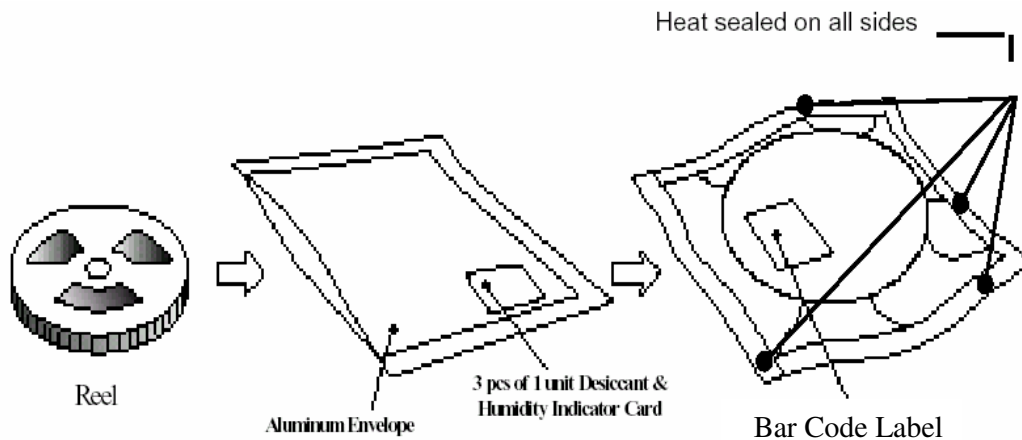



IRM-H1xx/TR2 SERIES

Packing Quantity Specification

1. 1500 PCS/1 Reel
2. 5Reel /1Carton

Label Form Specification

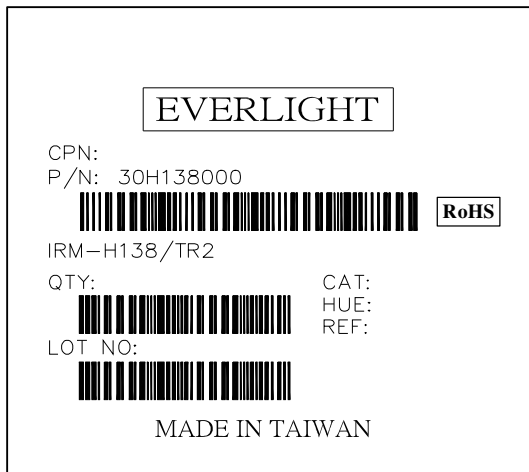

CPN: Customer's Production Number
P/N : Production Number
QTY: Packing Quantity
CAT: None
HUE: None
REF: Reference
LOT No: Lot Number
MADE IN TAIWAN: Production Place

Notes

1. Above specification may be changed without notice. EVERLIGHT will reserve authority on material change for above specification.
2. When using this product, please observe the absolute maximum ratings and the instructions for using outlined in these specification sheets. EVERLIGHT assumes no responsibility for any damage resulting from use of the product which does not comply with the absolute maximum ratings and the instructions included in these specification sheets.
3. These specification sheets include materials protected under copyright of EVERLIGHT corporation. Please don't reproduce or cause anyone to reproduce them without EVERLIGHT's consent.

EVERLIGHT ELECTRONICS CO., LTD.
Office: No 25, Lane 76, Sec 3, Chung Yang Rd,
Tucheng, Taipei 236, Taiwan, R.O.C

Tel: 886-2-2267-2000, 2267-9936
Fax: 886-2267-6244, 2267-6189, 2267-6306
<http://www.everlight.com>