

Optocoupler, Photodarlington Output, AC Input, High Gain (Single, Dual Channel)

Features

- AC or Polarity Insensitive Inputs
- Built-in Reverse Polarity Input Protection
- Industry Standard DIP Package
- Lead-free component
- Component in accordance to RoHS 2002/95/EC and WEEE 2002/96/EC

Agency Approvals

- UL1577, File No. E52744 System Code H or J, Double Protection
- CSA 93751
- BSI IEC60950 IEC60065
- DIN EN 60747-5-2 (VDE0884)
DIN EN 60747-5-5 pending
Available with Option 1

Applications

Designed for applications requiring detection or monitoring of AC signals.

Description

The IL755/ ILD755 are bidirectional input optically coupled isolators. They consist of two Gallium Arsenide infrared emitting diodes coupled to a silicon

Single Channel

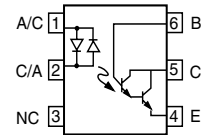
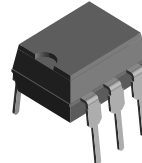

Dual Channel

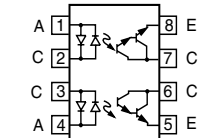
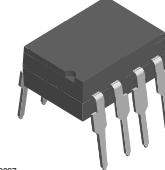

1179037



NPN photodarlington per channel.

The IL755 is single channel Darlington optocouplers. The ILD755 has two isolated channels in a single DIP package.

Order Information

Part	Remarks
IL755-1	CTR > 750 %, DIP-6
IL755-2	CTR > 1000 %, DIP-6
ILD755-1	CTR > 750 %, DIP-8
ILD755-2	CTR > 1000 %, DIP-8
IL755-1X007	CTR > 750 %, SMD-6 (option 7)

For additional information on the available options refer to Option Information.

Absolute Maximum Ratings

$T_{amb} = 25\text{ }^{\circ}\text{C}$, unless otherwise specified

Stresses in excess of the absolute Maximum Ratings can cause permanent damage to the device. Functional operation of the device is not implied at these or any other conditions in excess of those given in the operational sections of this document. Exposure to absolute Maximum Rating for extended periods of the time can adversely affect reliability.

Input

Parameter	Test condition	Symbol	Value	Unit
Forward continuous current		I_F	60	mA
Power dissipation		P_{diss}	100	mW
Derate linearly from 25 °C			1.33	mW/°C

Output

Parameter	Test condition	Part	Symbol	Value	Unit
Collector-emitter breakdown voltage			BV_{CEO}	60	V
Collector-base breakdown voltage			BV_{CBO}	60	V
Power dissipation		IL755-1	P_{diss}	200	mW
		IL755-2	P_{diss}	200	mW
		ILD755-1	P_{diss}	150	mW
		ILD755-2	P_{diss}	150	mW
Derate linearly from 25 °C		IL755-1		2.6	mW/°C
		IL755-2		2.6	mW/°C
		ILD755-1		2.0	mW/°C
		ILD755-2		2.0	mW/°C

Coupler

Parameter	Test condition	Part	Symbol	Value	Unit
Isolation test voltage (PK)	$t = 1.0 \text{ sec.}$		V_{ISO}	7500/5300	V_{ACPK}/V_{RMS}
Total power dissipation (LED plus detector)		IL755-1	P_{tot}	250	mW
		IL755-2	P_{tot}	250	mW
		ILD755-1	P_{tot}	400	mW
		ILD755-2	P_{tot}	400	mW
Derate linearly from 25 °C		IL755-1		3.0	mW/°C
		IL755-2		3.0	mW/°C
		ILD755-1		3.0	mW/°C
		ILD755-2		3.0	mW/°C
Creepage				≥ 7	mm
Clearance				≥ 7	mm
Storage temperature			T_{stg}	- 55 to + 150	°C
Operating temperature			T_{amb}	- 55 to + 100	°C
Lead soldering time at 260 °C				10	sec.

Electrical Characteristics

$T_{amb} = 25 \text{ °C}$, unless otherwise specified

Minimum and maximum values are testing requirements. Typical values are characteristics of the device and are the result of engineering evaluation. Typical values are for information only and are not part of the testing requirements.

Input

Parameter	Test condition	Symbol	Min	Typ.	Max	Unit
Forward voltage	$I_F = \pm 10 \text{ mA}$	V_F		1.2	1.5	V

Output

Parameter	Test condition	Symbol	Min	Typ.	Max	Unit
Collector-emitter breakdown voltage	$I_C = 1.0 \text{ mA}$	BV_{CEO}	60	75		V
Collector-base breakdown voltage	$I_C = 10 \text{ }\mu\text{A}$	BV_{CBO}	60	90		V
Collector-emitter leakage current	$V_{CE} = 10 \text{ V}$	I_{CEO}		10	100	nA

Coupler

Parameter	Test condition	Symbol	Min	Typ.	Max	Unit
Collector-emitter saturation voltage	$I_F = \pm 10 \text{ mA}$, $I_C = 10 \text{ mA}$	$V_{CE(sat)}$			1.0	V

Current Transfer Ratio

Parameter	Test condition	Part	Symbol	Min	Typ.	Max	Unit
Current Transfer Ratio	$V_{CE} = 5.0 \text{ V}$, $I_F = \pm 2.0 \text{ mA}$	IL755-1	CTR	750			%
		ILD755-1	CTR	750			%
	$V_{CE} = 5.0 \text{ V}$, $I_F = \pm 1.0 \text{ mA}$	IL755-2	CTR	1000			%
		ILD755-2	CTR	1000			%

Switching Characteristics

Parameter	Test condition	Part	Symbol	Min	Typ.	Max	Unit
Rise time	$V_{CC} = 10 \text{ V}$, $I_F = 2.0 \text{ mA}$, $R_L = 100 \Omega$	IL755-1	t_r		50		μs
		ILD755-1	t_r		50		μs
Fall time	$V_{CC} = 10 \text{ V}$, $I_F = 2.0 \text{ mA}$, $R_L = 100 \Omega$	IL755-1	t_f		50		μs
		ILD755-1	t_f		50		μs
Rise time	$V_{CC} = 10 \text{ V}$, $I_F = 1.0 \text{ mA}$, $R_L = 100 \Omega$	IL755-2	t_r		70		μs
		ILD755-2	t_r		70		μs
Fall time	$V_{CC} = 10 \text{ V}$, $I_F = 1.0 \text{ mA}$, $R_L = 100 \Omega$	IL755-2	t_f		70		μs
		ILD755-2	t_f		70		μs

Typical Characteristics ($T_{amb} = 25^\circ\text{C}$ unless otherwise specified)

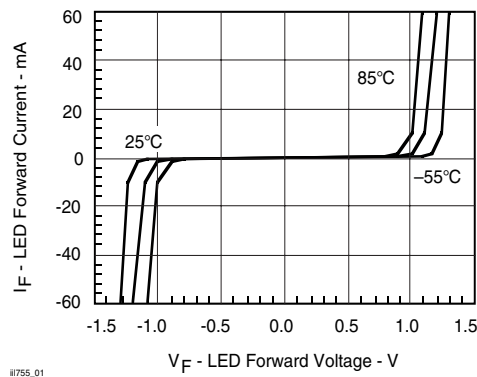

Figure 1. LED Forward Current vs. Forward Voltage

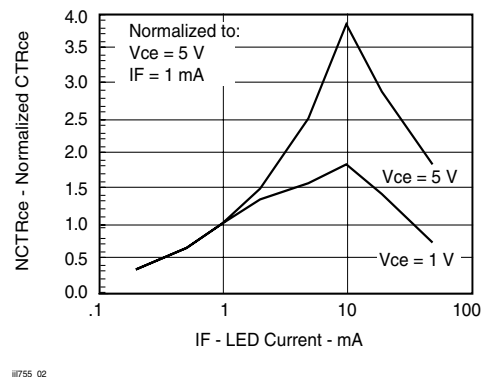
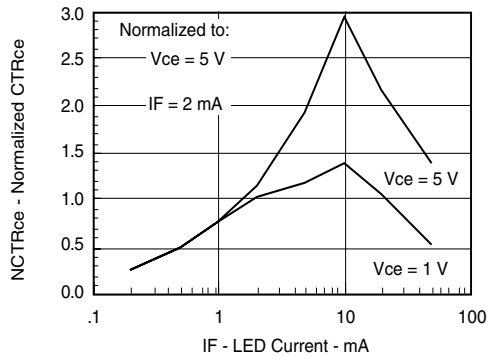
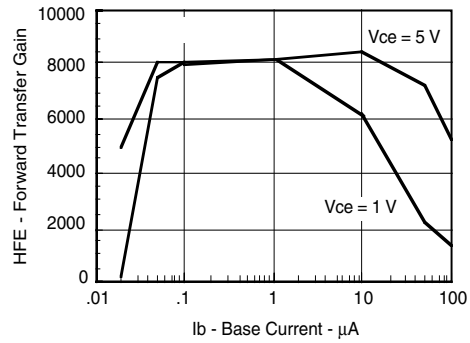

Figure 2. Normalized Non-saturated and Saturated CTR_{CE} vs. LED Current



||755_03

Figure 3. Normalized Non-saturated and Saturated CTR_{CE} vs. LED Current



||755_06

Figure 6. Non-Saturated and Saturated HFE vs. Base Current

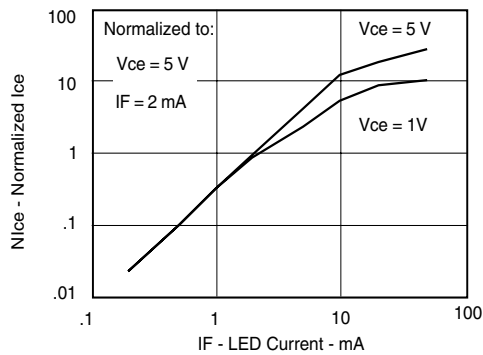

||755_04

Figure 4. Normalized Non-Saturated and Saturated I_{CE} vs. LED Current

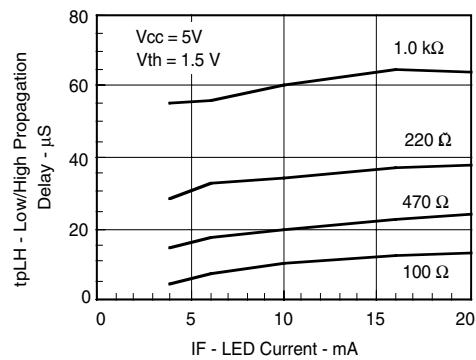

||755_07

Figure 7. Low to High Propagation Delay vs. Collector Load Resistance and LED Current

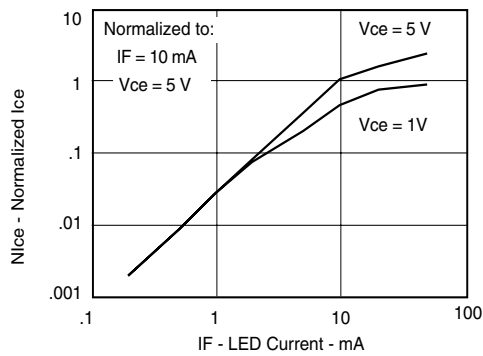

||755_05

Figure 5. Normalized Non-Saturated and Saturated Collector-Emitter Current vs. LED Current

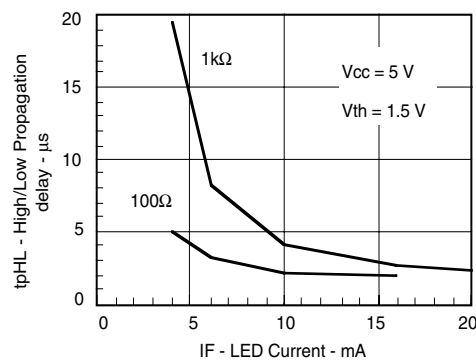

||755_08

Figure 8. High to low Propagation Delay vs. Collector Load Resistance and LED Current

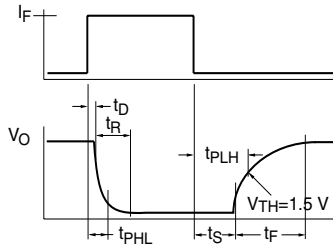

#755_09

Figure 9. Switching Waveform

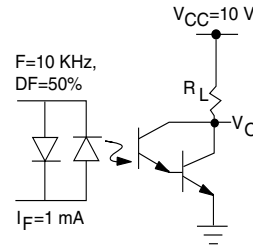

#755_10

Figure 10. Normalized Non-Saturated and Saturated CTR_{CE} vs. LED Current

Package Dimensions in Inches (mm)

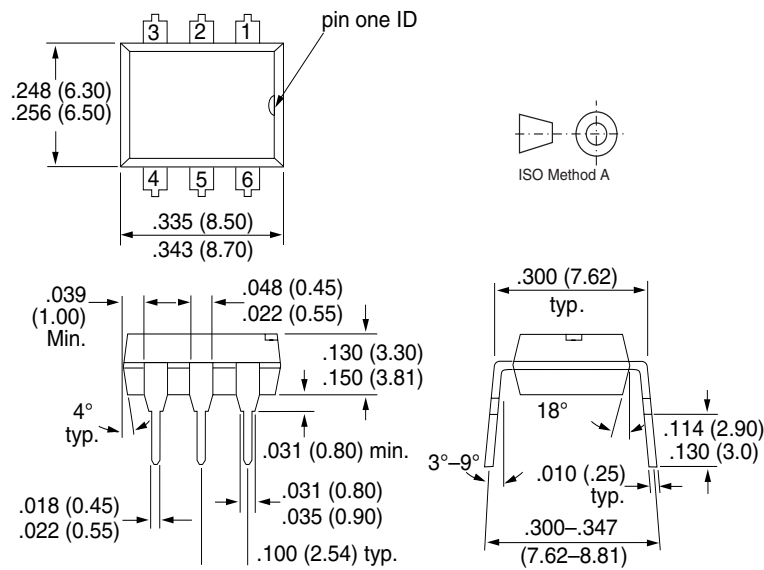

1178004

IL755/ ILD755

Vishay Semiconductors



Package Dimensions in Inches (mm)

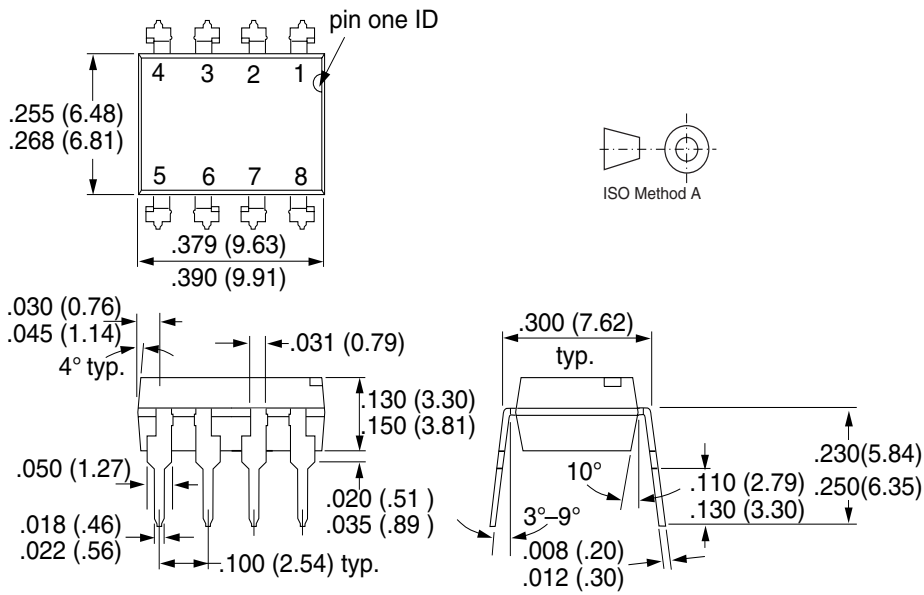

i178006

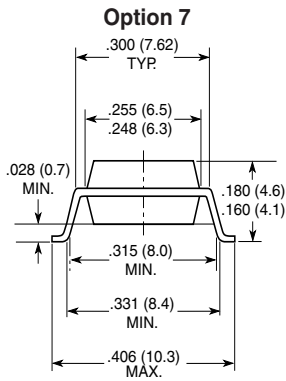

18447

Ozone Depleting Substances Policy Statement

It is the policy of Vishay Semiconductor GmbH to

1. Meet all present and future national and international statutory requirements.
2. Regularly and continuously improve the performance of our products, processes, distribution and operating systems with respect to their impact on the health and safety of our employees and the public, as well as their impact on the environment.

It is particular concern to control or eliminate releases of those substances into the atmosphere which are known as ozone depleting substances (ODSs).

The Montreal Protocol (1987) and its London Amendments (1990) intend to severely restrict the use of ODSs and forbid their use within the next ten years. Various national and international initiatives are pressing for an earlier ban on these substances.

Vishay Semiconductor GmbH has been able to use its policy of continuous improvements to eliminate the use of ODSs listed in the following documents.

1. Annex A, B and list of transitional substances of the Montreal Protocol and the London Amendments respectively
2. Class I and II ozone depleting substances in the Clean Air Act Amendments of 1990 by the Environmental Protection Agency (EPA) in the USA
3. Council Decision 88/540/EEC and 91/690/EEC Annex A, B and C (transitional substances) respectively.

Vishay Semiconductor GmbH can certify that our semiconductors are not manufactured with ozone depleting substances and do not contain such substances.

We reserve the right to make changes to improve technical design and may do so without further notice.

Parameters can vary in different applications. All operating parameters must be validated for each customer application by the customer. Should the buyer use Vishay Semiconductors products for any unintended or unauthorized application, the buyer shall indemnify Vishay Semiconductors against all claims, costs, damages, and expenses, arising out of, directly or indirectly, any claim of personal damage, injury or death associated with such unintended or unauthorized use.

Vishay Semiconductor GmbH, P.O.B. 3535, D-74025 Heilbronn, Germany
Telephone: 49 (0)7131 67 2831, Fax number: 49 (0)7131 67 2423



Notice

Specifications of the products displayed herein are subject to change without notice. Vishay Intertechnology, Inc., or anyone on its behalf, assumes no responsibility or liability for any errors or inaccuracies.

Information contained herein is intended to provide a product description only. No license, express or implied, by estoppel or otherwise, to any intellectual property rights is granted by this document. Except as provided in Vishay's terms and conditions of sale for such products, Vishay assumes no liability whatsoever, and disclaims any express or implied warranty, relating to sale and/or use of Vishay products including liability or warranties relating to fitness for a particular purpose, merchantability, or infringement of any patent, copyright, or other intellectual property right.

The products shown herein are not designed for use in medical, life-saving, or life-sustaining applications. Customers using or selling these products for use in such applications do so at their own risk and agree to fully indemnify Vishay for any damages resulting from such improper use or sale.