

*Single switch
Series & SiC parallel diodes
MOSFET Power Module*

$V_{DSS} = 1000V$

$R_{DSon} = 65m\Omega$ typ @ $T_j = 25^\circ C$

$I_D = 145A$ @ $T_c = 25^\circ C$

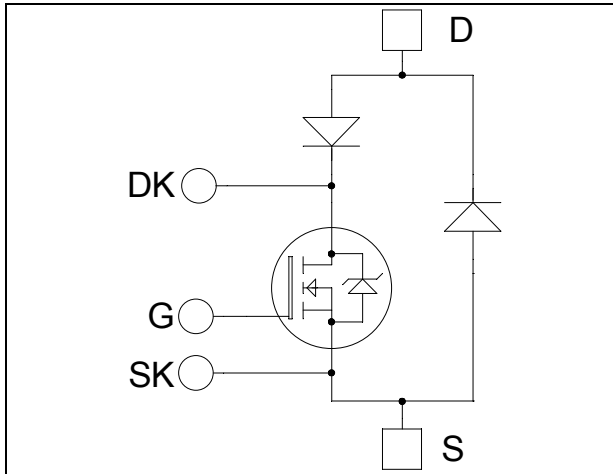

G, SK and DK terminals are for control signals only (not for power)

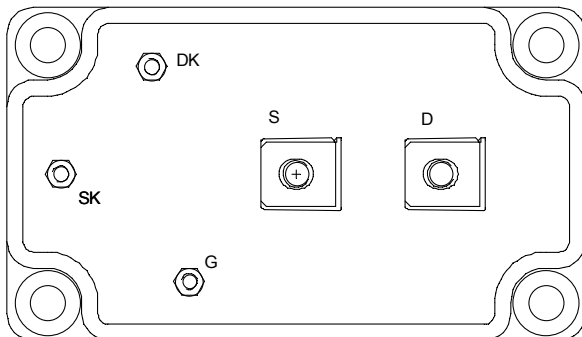

Application

- Welding converters
- Switched Mode Power Supplies
- Uninterruptible Power Supplies
- Motor control

Features

- **Power MOS 7[®] MOSFETs**
 - Low R_{DSon}
 - Low input and Miller capacitance
 - Low gate charge
 - Avalanche energy rated
 - Very rugged
- **SiC Parallel Schottky Diode**
 - Zero reverse recovery
 - Zero forward recovery
 - Temperature Independent switching behavior
 - Positive temperature coefficient on VF
- Kelvin source for easy drive
- Kelvin drain for voltage monitoring
- Very low stray inductance
 - Symmetrical design
 - M5 power connectors
 - M3 power connectors
- High level of integration
- AlN substrate for improved MOSFET thermal performance

Benefits

- Outstanding performance at high frequency operation
- Direct mounting to heatsink (isolated package)
- Low junction to case thermal resistance
- Low profile
- RoHS Compliant

All ratings @ $T_j = 25^\circ C$ unless otherwise specified

CAUTION: These Devices are sensitive to Electrostatic Discharge. Proper Handling Procedures Should Be Followed. See application note APT0502 on www.microsemi.com

Absolute maximum ratings

<i>Symbol</i>	<i>Parameter</i>	<i>Max ratings</i>	<i>Unit</i>
V _{DSS}	Drain - Source Breakdown Voltage	1000	V
I _D	Continuous Drain Current	T _c = 25°C	145
		T _c = 80°C	110
I _{DM}	Pulsed Drain current	580	A
V _{GS}	Gate - Source Voltage	±30	V
R _{DS(on)}	Drain - Source ON Resistance	78	mΩ
P _D	Maximum Power Dissipation	T _c = 25°C	3250
I _{AR}	Avalanche current (repetitive and non repetitive)	30	A
E _{AR}	Repetitive Avalanche Energy	50	mJ
E _{AS}	Single Pulse Avalanche Energy	3200	

Electrical Characteristics

<i>Symbol</i>	<i>Characteristic</i>	<i>Test Conditions</i>	<i>Min</i>	<i>Typ</i>	<i>Max</i>	<i>Unit</i>
I _{DSS}	Zero Gate Voltage Drain Current	V _{GS} = 0V, V _{DS} = 1000V	T _j = 25°C		400	μA
		V _{GS} = 0V, V _{DS} = 800V	T _j = 125°C		2	mA
R _{DS(on)}	Drain – Source on Resistance	V _{GS} = 10V, I _D = 72.5A		65	78	mΩ
V _{GS(th)}	Gate Threshold Voltage	V _{GS} = V _{DS} , I _D = 20mA	3		5	V
I _{GSS}	Gate – Source Leakage Current	V _{GS} = ±30 V, V _{DS} = 0V			±400	nA

Dynamic Characteristics

<i>Symbol</i>	<i>Characteristic</i>	<i>Test Conditions</i>	<i>Min</i>	<i>Typ</i>	<i>Max</i>	<i>Unit</i>
C _{iss}	Input Capacitance	V _{GS} = 0V V _{DS} = 25V f = 1MHz		28.5		nF
C _{oss}	Output Capacitance			5.08		
C _{rss}	Reverse Transfer Capacitance			0.9		
Q _g	Total gate Charge	V _{GS} = 10V V _{Bus} = 500V I _D = 145A		1068		nC
Q _{gs}	Gate – Source Charge			136		
Q _{gd}	Gate – Drain Charge			692		
T _{d(on)}	Turn-on Delay Time	V _{GS} = 15V V _{Bus} = 670V I _D = 145A R _G = 0.75Ω		18		ns
T _r	Rise Time			14		
T _{d(off)}	Turn-off Delay Time			140		
T _f	Fall Time			55		
E _{on}	Turn-on Switching Energy	Inductive switching @ 25°C V _{GS} = 15V, V _{Bus} = 670V I _D = 145A, R _G = 0.75Ω		2.9		mJ
E _{off}	Turn-off Switching Energy			2.9		
E _{on}	Turn-on Switching Energy	Inductive switching @ 125°C V _{GS} = 15V, V _{Bus} = 670V I _D = 145A, R _G = 0.75Ω		4.8		mJ
E _{off}	Turn-off Switching Energy			3.9		

Series diode ratings and characteristics

<i>Symbol</i>	<i>Characteristic</i>	<i>Test Conditions</i>		<i>Min</i>	<i>Typ</i>	<i>Max</i>	<i>Unit</i>
V _{RRM}	Maximum Peak Repetitive Reverse Voltage			200			V
I _{RM}	Maximum Reverse Leakage Current	V _R =200V	T _j = 25°C			350	μA
			T _j = 125°C			600	
I _F	DC Forward Current	T _c = 80°C			120		A
V _F	Diode Forward Voltage	I _F = 120A			1.1	1.15	V
		I _F = 240A			1.4		
		I _F = 120A	T _j = 125°C		0.9		
t _{rr}	Reverse Recovery Time	I _F = 120A V _R = 133V di/dt = 400A/μs	T _j = 25°C		31		ns
			T _j = 125°C		60		
Q _{rr}	Reverse Recovery Charge				120		nC
					500		

SiC Parallel diode ratings and characteristics

<i>Symbol</i>	<i>Characteristic</i>	<i>Test Conditions</i>		<i>Min</i>	<i>Typ</i>	<i>Max</i>	<i>Unit</i>
V _{RRM}	Maximum Peak Repetitive Reverse Voltage			1200			V
I _{RM}	Maximum Reverse Leakage Current	V _R =1200V	T _j = 25°C		384	2400	μA
			T _j = 125°C		672	12000	
I _F	DC Forward Current	T _c = 125°C			120		A
V _F	Diode Forward Voltage	I _F = 120A	T _j = 25°C		1.6	1.8	V
			T _j = 175°C		2.3	3.0	
Q _C	Total Capacitive Charge	I _F = 120A, V _R = 600V di/dt = 5000A/μs			480		nC
C	Total Capacitance	f = 1MHz, V _R = 200V			1152		pF
		f = 1MHz, V _R = 400V			828		

Thermal and package characteristics

<i>Symbol</i>	<i>Characteristic</i>			<i>Min</i>	<i>Typ</i>	<i>Max</i>	<i>Unit</i>
R _{thJC}	Junction to Case Thermal Resistance	Transistor				0.038	°C/W
		Series diode				0.46	
		SiC Parallel diode				0.18	
V _{ISOL}	RMS Isolation Voltage, any terminal to case t=1 min, I _{isol} <1mA, 50/60Hz			4000			V
T _J	Operating junction temperature range			-40		150	°C
T _{STG}	Storage Temperature Range			-40		125	
T _C	Operating Case Temperature			-40		100	
Torque	Mounting torque	To heatsink	M6	3		5	N.m
		For terminals	M5	2		3.5	
			M3	1		1.5	
Wt	Package Weight					280	g

SP6 Package outline (dimensions in mm)

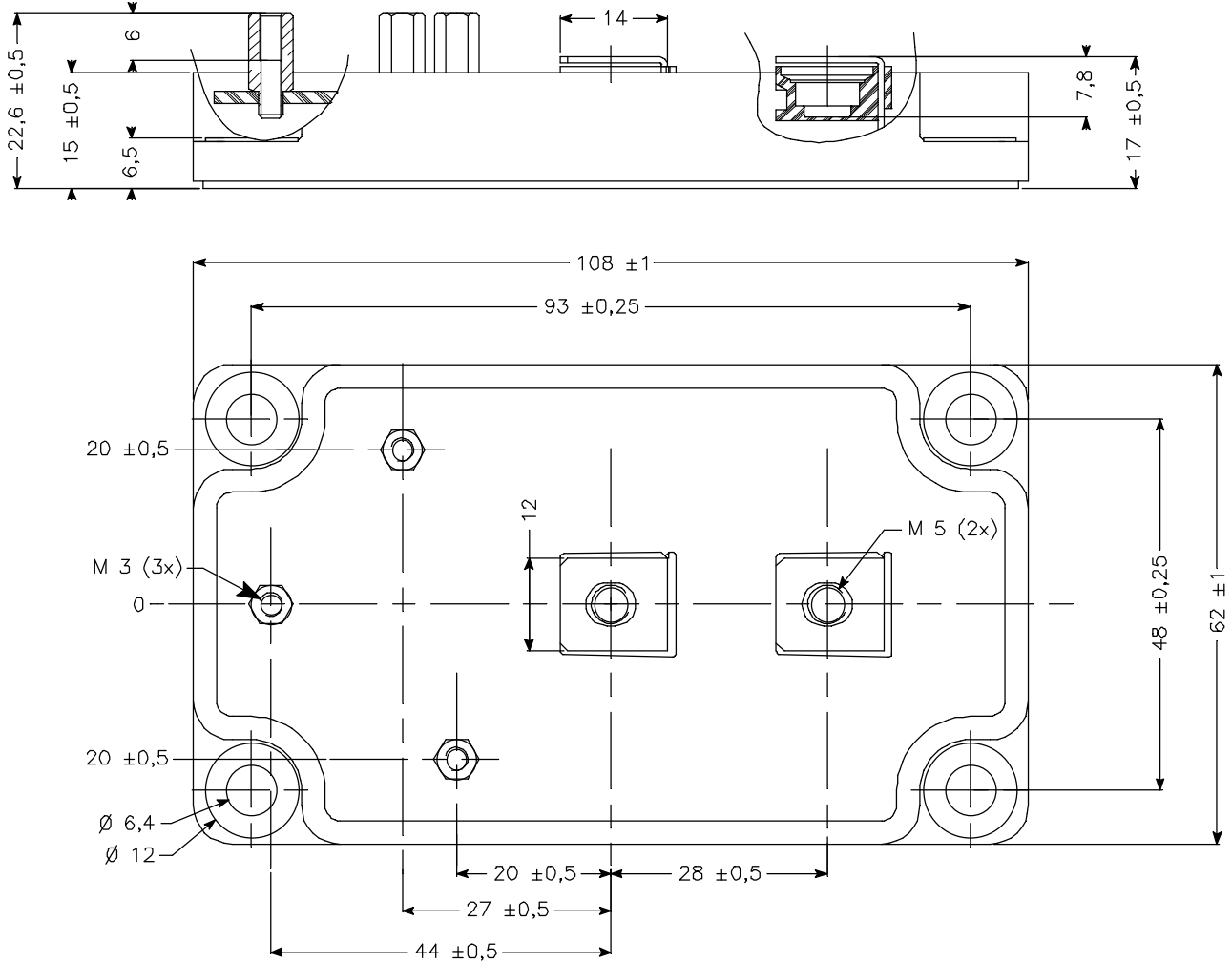

See application note APT0601 - Mounting Instructions for SP6 Power Modules on www.microsemi.com

Typical MOSFET Performance Curve

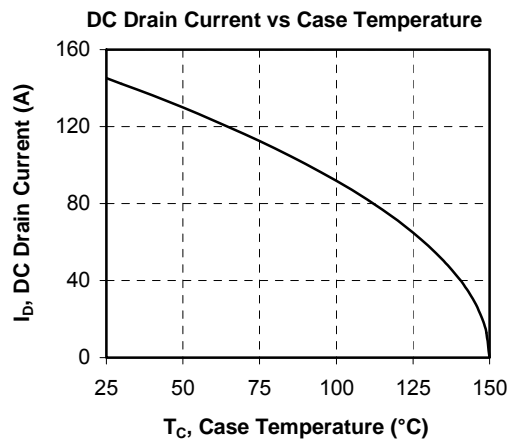
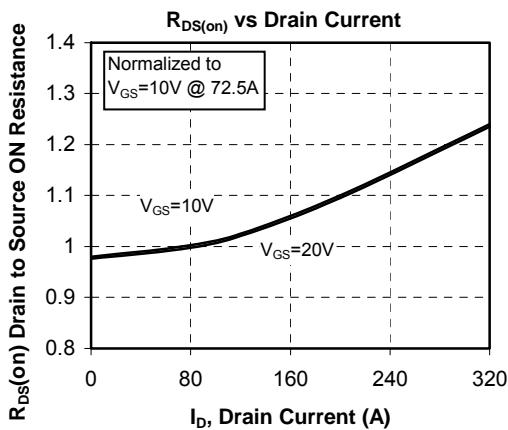
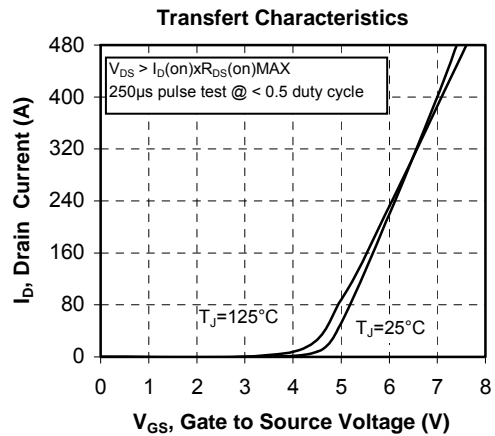
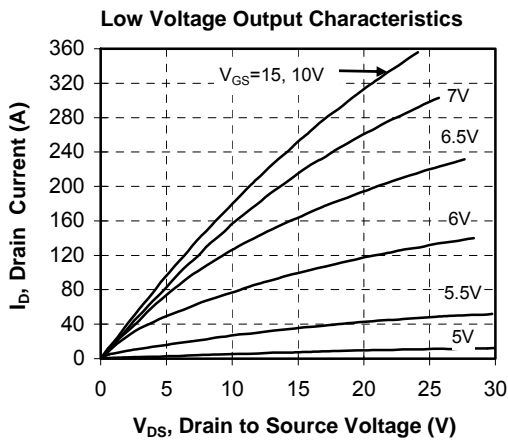
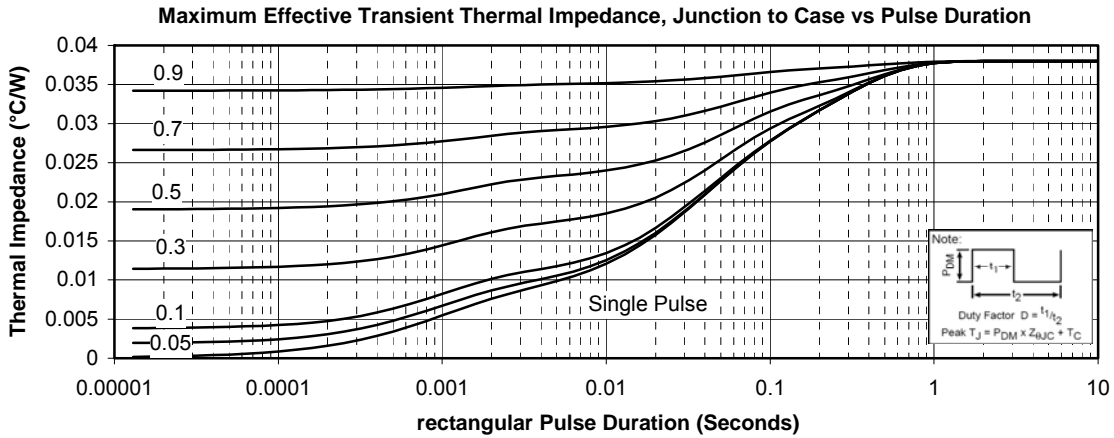

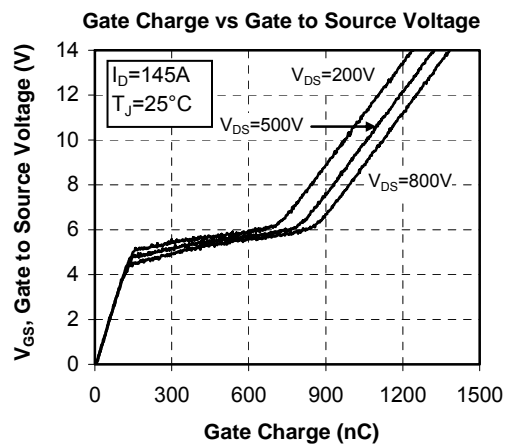
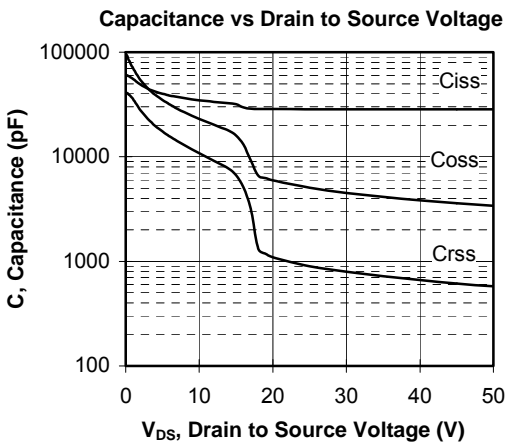
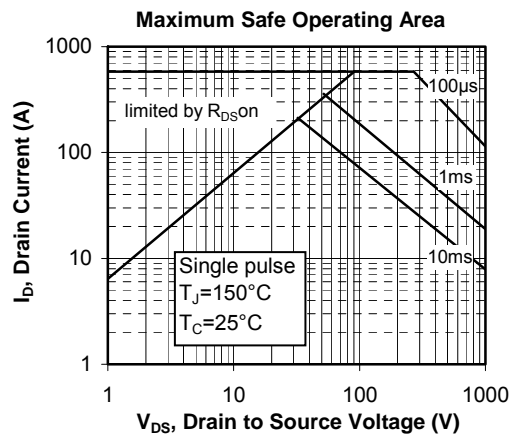
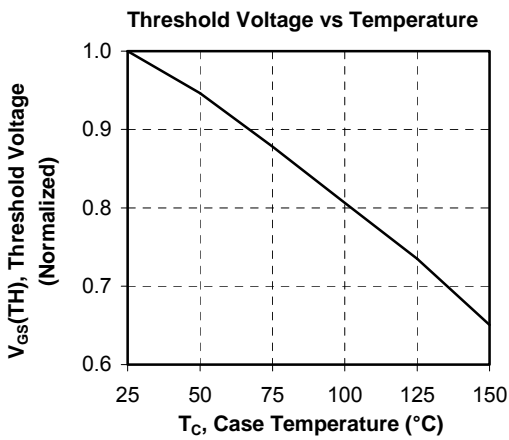
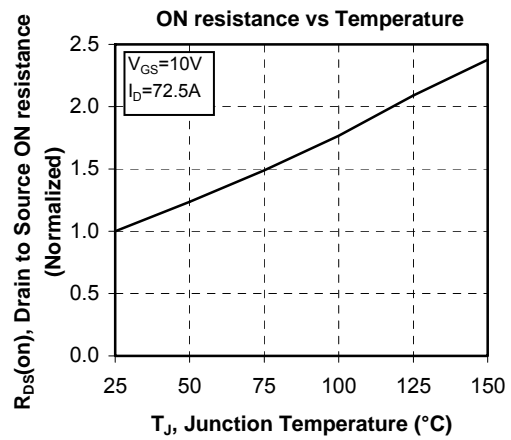
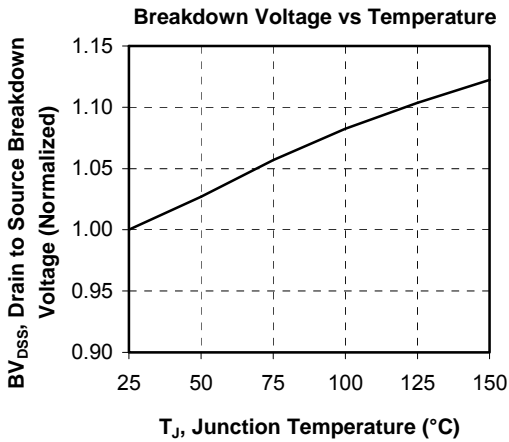

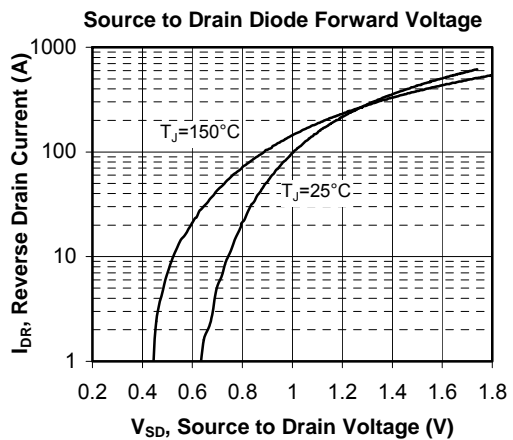
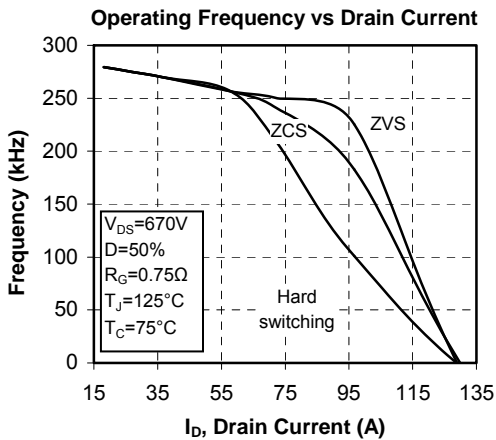
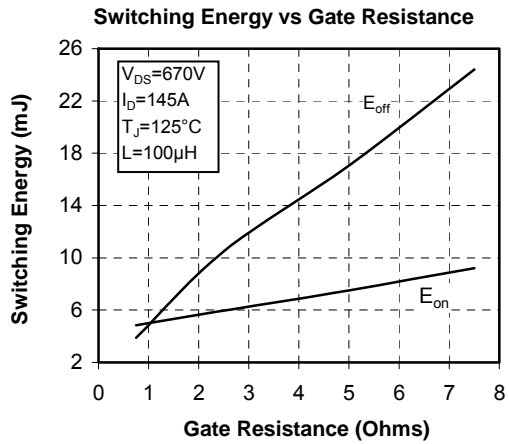
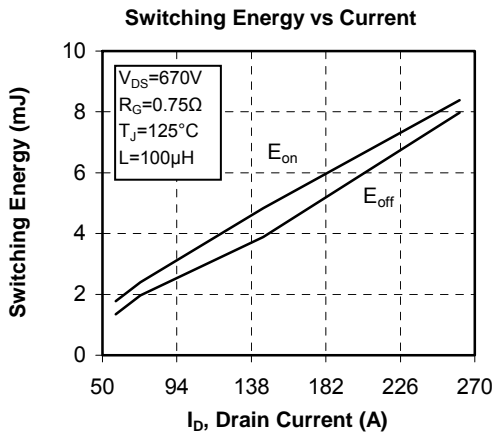
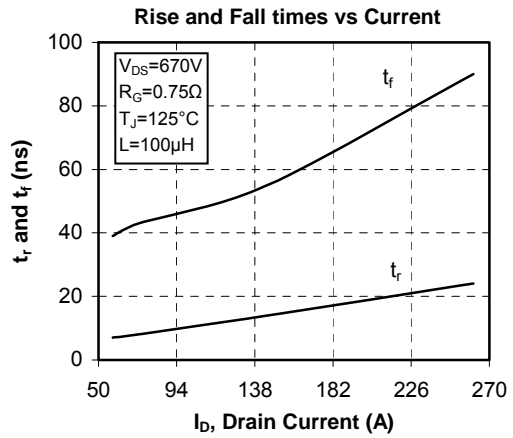
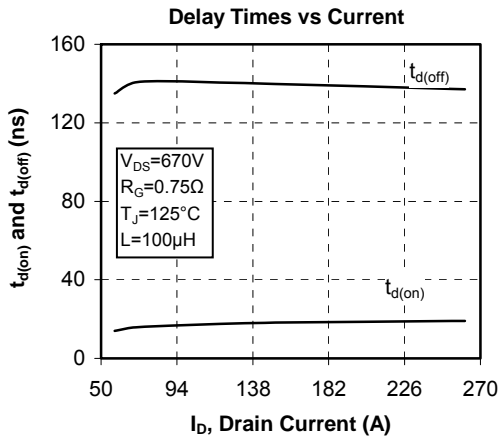

Typical SiC Diode Performance Curve

Maximum Effective Transient Thermal Impedance, Junction to Case vs Pulse Duration

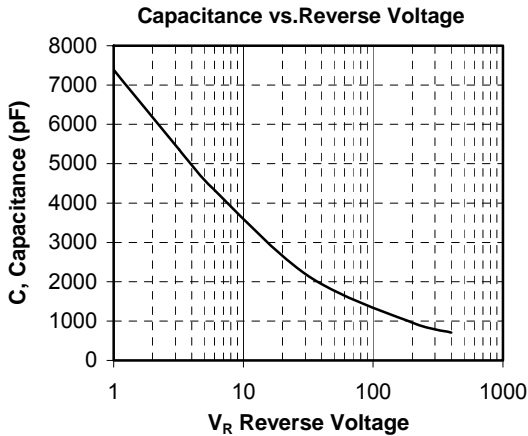
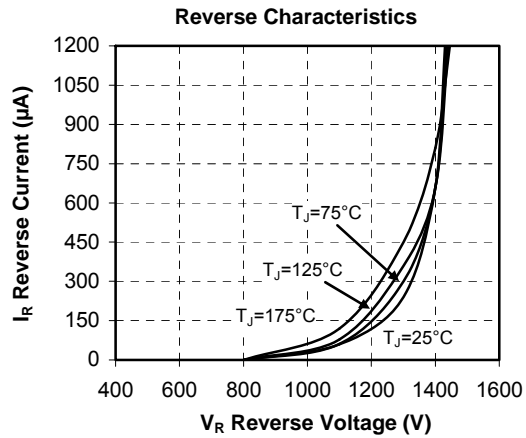
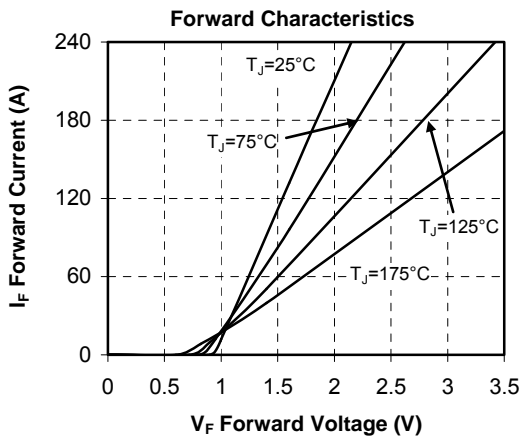
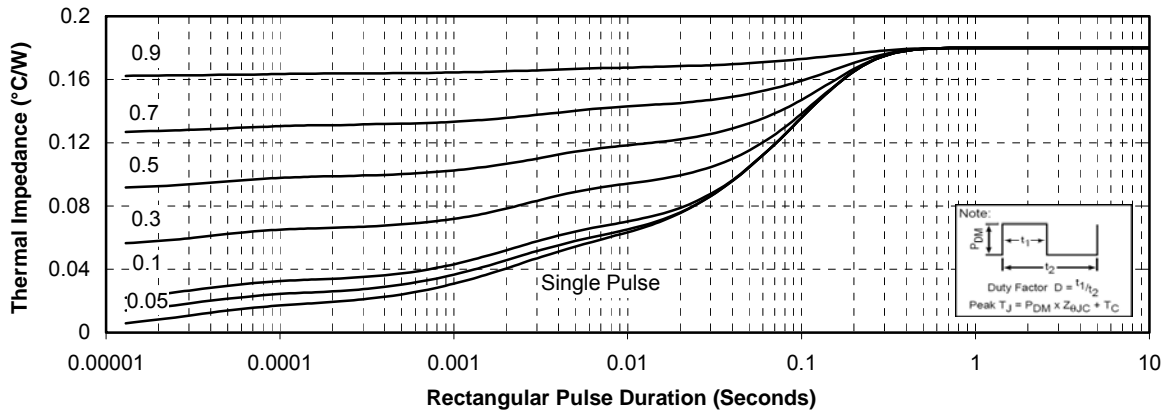

Microsemi reserves the right to change, without notice, the specifications and information contained herein

Microsemi's products are covered by one or more of U.S. patents 4,895,810 5,045,903 5,089,434 5,182,234 5,019,522 5,262,336 6,503,786 5,256,583 4,748,103 5,283,202 5,231,474 5,434,095 5,528,058 6,939,743 7,352,045 5,283,201 5,801,417 5,648,283 7,196,634 6,664,594 7,157,886 6,939,743 7,342,262 and foreign patents. U.S and Foreign patents pending. All Rights Reserved.