

*Three level inverter
CoolMOS & Trench + Field Stop IGBT
Power Module*

Trench & Field Stop IGBT Q2, Q3:
 $V_{CES} = 600V$; $I_C = 75A$ @ $T_c = 80^\circ C$

CoolMOS™ Q1, Q4:
 $V_{DSS} = 600V$; $I_D = 70A$ @ $T_c = 80^\circ C$

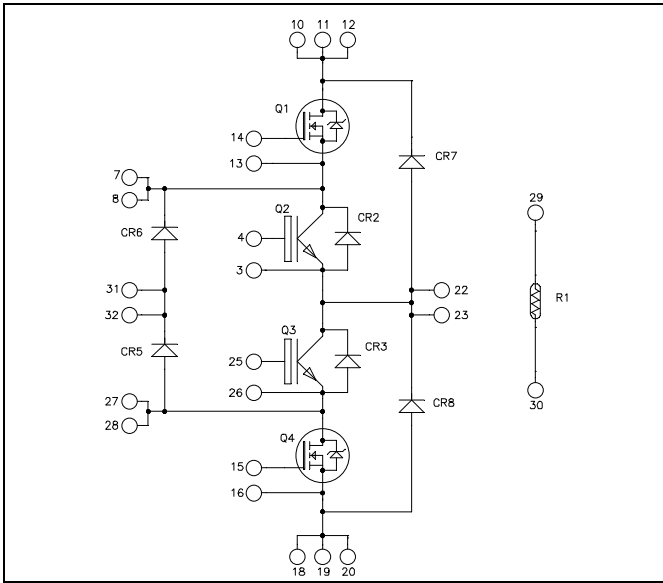

Application

- Solar converter
- Uninterruptible Power Supplies

Features

- **Q2, Q3 Trench + Field Stop IGBT Technology**
 - Low voltage drop
 - Low tail current
 - Switching frequency up to 20 kHz
 - Soft recovery parallel diodes
 - Low diode VF
 - Low leakage current
 - RBSOA and SCSOA rated

- **Q1, Q4 CoolMOS™**
 - Ultra low R_{DSon}
 - Low Miller capacitance
 - Ultra low gate charge
 - Avalanche energy rated
 - Very rugged

- Kelvin emitter for easy drive
- Very low stray inductance
- High level of integration
- Internal thermistor for temperature monitoring

Benefits

- Stable temperature behavior
- Very rugged
- Direct mounting to heatsink (isolated package)
- Low junction to case thermal resistance
- Easy paralleling due to positive TC of V_{CEsat}
- Low profile
- RoHS Compliant

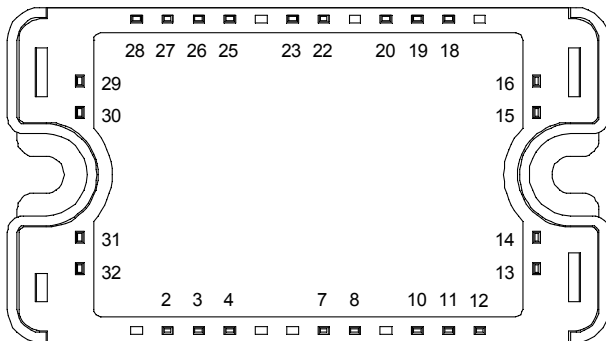

All multiple inputs and outputs must be shorted together
 Example: 10/11/12 ; 7/8 ...

All ratings @ $T_j = 25^\circ C$ unless otherwise specified

CAUTION: These Devices are sensitive to Electrostatic Discharge. Proper Handling Procedures Should Be Followed.
 See application note APT0502 on www.microsemi.com

Q1 & Q4 Absolute maximum ratings

Symbol	Parameter	Max ratings	Unit
V _{DSS}	Drain - Source Breakdown Voltage	600	V
I _D	Continuous Drain Current	T _c = 25°C	95
		T _c = 80°C	70
I _{DM}	Pulsed Drain current	260	A
V _{GS}	Gate - Source Voltage	±20	V
R _{DS(on)}	Drain - Source ON Resistance	24	mΩ
P _D	Maximum Power Dissipation	T _c = 25°C	462
I _{AR}	Avalanche current (repetitive and non repetitive)	15	A
E _{AR}	Repetitive Avalanche Energy	3	mJ
E _{AS}	Single Pulse Avalanche Energy	1900	

Q1 & Q4 Electrical Characteristics

Symbol	Characteristic	Test Conditions	Min	Typ	Max	Unit
I _{DSS}	Zero Gate Voltage Drain Current	V _{GS} = 0V, V _{DS} = 600V T _j = 25°C			350	μA
		V _{GS} = 0V, V _{DS} = 600V T _j = 125°C			600	
R _{DS(on)}	Drain – Source on Resistance	V _{GS} = 10V, I _D = 47.5A			24	mΩ
V _{GS(th)}	Gate Threshold Voltage	V _{GS} = V _{DS} , I _D = 5mA	2.1	3	3.9	V
I _{GSS}	Gate – Source Leakage Current	V _{GS} = ±20 V, V _{DS} = 0V			200	nA

Q1 & Q4 Dynamic Characteristics

Symbol	Characteristic	Test Conditions	Min	Typ	Max	Unit
C _{iss}	Input Capacitance	V _{GS} = 0V ; V _{DS} = 25V f = 1MHz		14.4		nF
C _{oss}	Output Capacitance			17		
Q _g	Total gate Charge	V _{GS} = 10V V _{Bus} = 300V I _D = 95A		300		nC
Q _{gs}	Gate – Source Charge			68		
Q _{gd}	Gate – Drain Charge			102		
T _{d(on)}	Turn-on Delay Time	Inductive Switching (125°C) V _{GS} = 10V V _{Bus} = 400V I _D = 95A R _G = 2.5Ω		21		ns
T _r	Rise Time			30		
T _{d(off)}	Turn-off Delay Time			100		
T _f	Fall Time			45		
E _{on}	Turn-on Switching Energy	Inductive switching @ 25°C V _{GS} = 10V ; V _{Bus} = 400V I _D = 95A ; R _G = 2.5Ω		1350		μJ
E _{off}	Turn-off Switching Energy			1040		
E _{on}	Turn-on Switching Energy	Inductive switching @ 125°C V _{GS} = 10V ; V _{Bus} = 400V I _D = 95A ; R _G = 2.5Ω		2200		μJ
E _{off}	Turn-off Switching Energy			1270		
R _{thJC}	Junction to Case Thermal Resistance				0.27	°C/W

Q2 & Q3 Absolute maximum ratings

<i>Symbol</i>	<i>Parameter</i>		<i>Max ratings</i>	<i>Unit</i>
V _{CES}	Collector - Emitter Breakdown Voltage		600	V
I _C	Continuous Collector Current	T _C = 25°C	100	A
		T _C = 80°C	75	
I _{CM}	Pulsed Collector Current	T _C = 25°C	140	
V _{GE}	Gate - Emitter Voltage		±20	V
P _D	Maximum Power Dissipation	T _C = 25°C	250	W
RBSOA	Reverse Bias Safe Operating Area	T _J = 150°C	150A @ 550V	

Q2 & Q3 Electrical Characteristics

<i>Symbol</i>	<i>Characteristic</i>	<i>Test Conditions</i>	<i>Min</i>	<i>Typ</i>	<i>Max</i>	<i>Unit</i>
I _{CES}	Zero Gate Voltage Collector Current	V _{GE} = 0V, V _{CE} = 600V			250	μA
V _{CE(sat)}	Collector Emitter Saturation Voltage	V _{GE} = 15V I _C = 75A	T _J = 25°C	1.5	1.9	V
			T _J = 150°C	1.7		
V _{GE(th)}	Gate Threshold Voltage	V _{GE} = V _{CE} , I _C = 600μA	5.0	5.8	6.5	V
I _{GES}	Gate - Emitter Leakage Current	V _{GE} = 20V, V _{CE} = 0V			600	nA

Q2 & Q3 Dynamic Characteristics

<i>Symbol</i>	<i>Characteristic</i>	<i>Test Conditions</i>	<i>Min</i>	<i>Typ</i>	<i>Max</i>	<i>Unit</i>
C _{ies}	Input Capacitance	V _{GE} = 0V V _{CE} = 25V f = 1MHz		4620		pF
C _{oes}	Output Capacitance			300		
C _{res}	Reverse Transfer Capacitance			140		
Q _G	Gate charge	V _{GE} = ±15V, I _C = 75A V _{CE} = 300V		0.8		μC
T _{d(on)}	Turn-on Delay Time	Inductive Switching (25°C) V _{GE} = ±15V V _{Bus} = 300V I _C = 75A R _G = 4.7Ω		110		ns
T _r	Rise Time			45		
T _{d(off)}	Turn-off Delay Time			200		
T _f	Fall Time			40		
T _{d(on)}	Turn-on Delay Time	Inductive Switching (150°C) V _{GE} = ±15V V _{Bus} = 300V I _C = 75A R _G = 4.7Ω		120		ns
T _r	Rise Time			50		
T _{d(off)}	Turn-off Delay Time			250		
T _f	Fall Time			60		
E _{on}	Turn-on Switching Energy	V _{GE} = ±15V V _{Bus} = 300V I _C = 75A	T _J = 25°C	0.35		mJ
			T _J = 150°C	0.6		
E _{off}	Turn-off Switching Energy	R _G = 4.7Ω	T _J = 25°C	2.2		mJ
			T _J = 150°C	2.6		
I _{sc}	Short Circuit data	V _{GE} ≤ 15V ; V _{Bus} = 360V t _p ≤ 6μs ; T _J = 150°C		380		A
R _{thJC}	Junction to Case Thermal Resistance				0.60	°C/W

CR2 & CR3 diode ratings and characteristics

<i>Symbol</i>	<i>Characteristic</i>	<i>Test Conditions</i>		<i>Min</i>	<i>Typ</i>	<i>Max</i>	<i>Unit</i>
V_{RRM}	Maximum Peak Repetitive Reverse Voltage			1200			V
I_{RM}	Maximum Reverse Leakage Current	$V_R=1200V$	$T_j = 25^\circ C$			100	μA
			$T_j = 125^\circ C$			500	
I_F	DC Forward Current		$T_c = 80^\circ C$		15		A
V_F	Diode Forward Voltage	$I_F = 15A$			2.8	3.3	V
		$I_F = 30A$			3.4		
		$I_F = 15A$	$T_j = 125^\circ C$		2.4		
t_{rr}	Reverse Recovery Time	$I_F = 15A$	$T_j = 25^\circ C$		240		ns
			$T_j = 125^\circ C$		290		
Q_{rr}	Reverse Recovery Charge	$V_R = 800V$ $di/dt = 200A/\mu s$	$T_j = 25^\circ C$		260		nC
			$T_j = 125^\circ C$		960		
E_{rr}	Reverse Recovery Energy	$I_F = 15A$ $V_R = 800V$ $di/dt = 1000A/\mu s$	$T_j = 125^\circ C$		0.9		mJ
R_{thJC}	Junction to Case Thermal Resistance					2	$^\circ C/W$

CR5 & CR6 diode ratings and characteristics

<i>Symbol</i>	<i>Characteristic</i>	<i>Test Conditions</i>		<i>Min</i>	<i>Typ</i>	<i>Max</i>	<i>Unit</i>
V_{RRM}	Maximum Peak Repetitive Reverse Voltage			600			V
I_{RM}	Maximum Reverse Leakage Current	$V_R=600V$	$T_j = 25^\circ C$			25	μA
			$T_j = 125^\circ C$			500	
I_F	DC Forward Current		$T_c = 80^\circ C$		30		A
V_F	Diode Forward Voltage	$I_F = 30A$			1.8	2.2	V
		$I_F = 60A$			2.2		
		$I_F = 30A$	$T_j = 125^\circ C$		1.5		
t_{rr}	Reverse Recovery Time	$I_F = 30A$	$T_j = 25^\circ C$		25		ns
			$T_j = 125^\circ C$		160		
Q_{rr}	Reverse Recovery Charge	$V_R = 400V$ $di/dt = 200A/\mu s$	$T_j = 25^\circ C$		35		nC
			$T_j = 125^\circ C$		480		
E_{rr}	Reverse Recovery Energy	$I_F = 30A$ $V_R = 400V$ $di/dt = 1000A/\mu s$	$T_j = 125^\circ C$		0.6		mJ
R_{thJC}	Junction to Case Thermal Resistance					1.2	$^\circ C/W$

CR7 & CR8 diode ratings and characteristics

<i>Symbol</i>	<i>Characteristic</i>	<i>Test Conditions</i>		<i>Min</i>	<i>Typ</i>	<i>Max</i>	<i>Unit</i>
V _{RRM}	Maximum Peak Repetitive Reverse Voltage			1200			V
I _{RM}	Maximum Reverse Leakage Current	V _R =1200V	T _j = 25°C			100	μA
			T _j = 125°C			500	
I _F	DC Forward Current		T _c = 80°C		30		A
V _F	Diode Forward Voltage	I _F = 30A			2.6	3.1	V
		I _F = 60A			3.2		
		I _F = 30A	T _j = 125°C		1.8		
t _{rr}	Reverse Recovery Time	I _F = 30A V _R = 800V	T _j = 25°C		300		ns
			T _j = 125°C		380		
Q _{rr}	Reverse Recovery Charge	di/dt = 200A/μs	T _j = 25°C		360		nC
			T _j = 125°C		1700		
E _{rr}	Reverse Recovery Energy	I _F = 30A V _R = 800V di/dt = 1000A/μs	T _j = 125°C		1.6		mJ
R _{thJC}	Junction to Case Thermal Resistance					1.2	°C/W

Temperature sensor NTC (see application note APT0406 on www.microsemi.com for more information).

<i>Symbol</i>	<i>Characteristic</i>	<i>Min</i>	<i>Typ</i>	<i>Max</i>	<i>Unit</i>
R ₂₅	Resistance @ 25°C		50		kΩ
ΔR ₂₅ /R ₂₅			5		%
B _{25/85}	T ₂₅ = 298.15 K		3952		K
ΔB/B		T _C =100°C	4		%

$$R_T = \frac{R_{25}}{\exp\left[B_{25/85}\left(\frac{1}{T_{25}} - \frac{1}{T}\right)\right]}$$

T: Thermistor temperature
 R_T: Thermistor value at T

Thermal and package characteristics

Symbol	Characteristic	Min	Typ	Max	Unit	
V_{ISOL}	RMS Isolation Voltage, any terminal to case $t=1$ min, $I_{isol}<1$ mA, 50/60Hz	2500			V	
T_J	Operating junction temperature range	-40		175*	°C	
T_{STG}	Storage Temperature Range	-40		125		
T_C	Operating Case Temperature	-40		100		
Torque	Mounting torque	To heatsink	M4	2.5	4.7	N.m
Wt	Package Weight				110	g

* $T_{jmax} = 150^{\circ}\text{C}$ for Q1 & Q4

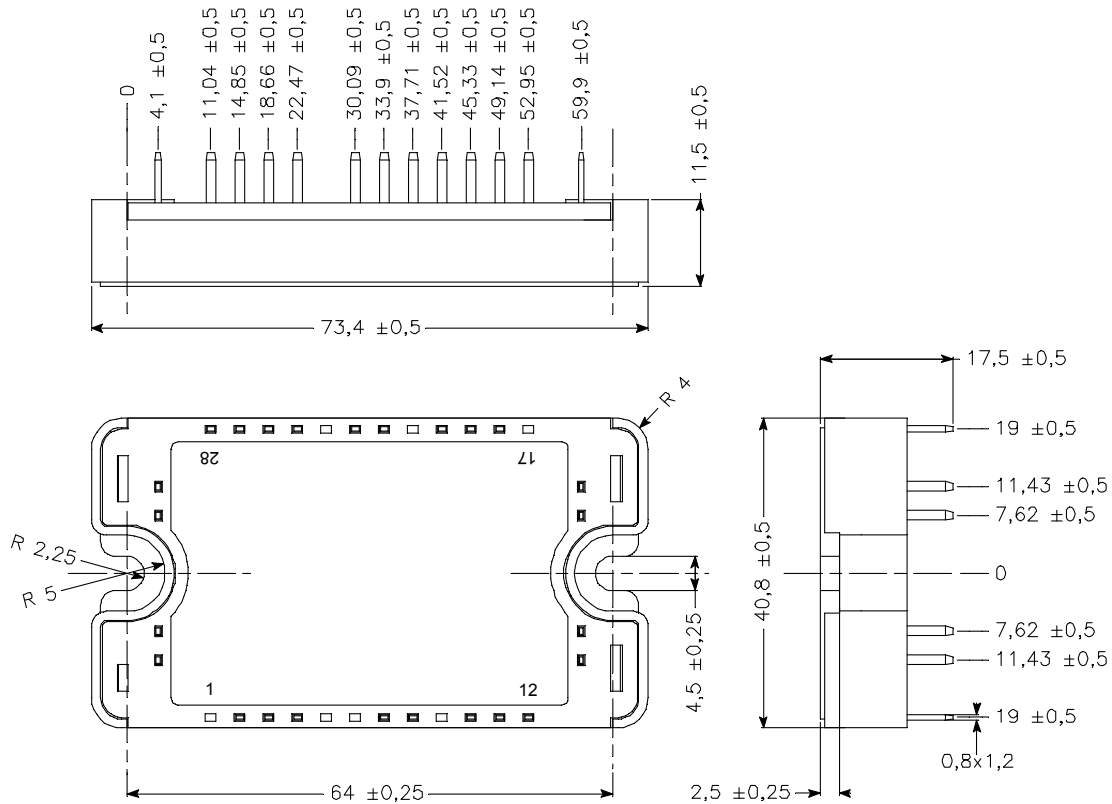
SP3 Package outline (dimensions in mm)

See application note 1901 - Mounting Instructions for SP3 Power Modules on www.microsemi.com

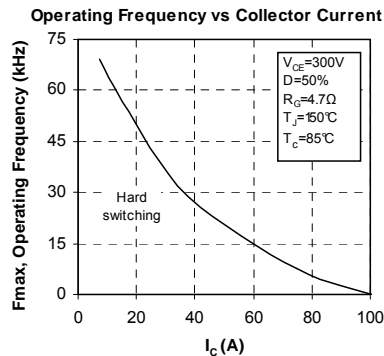
Q2 & Q3 Typical performance curve

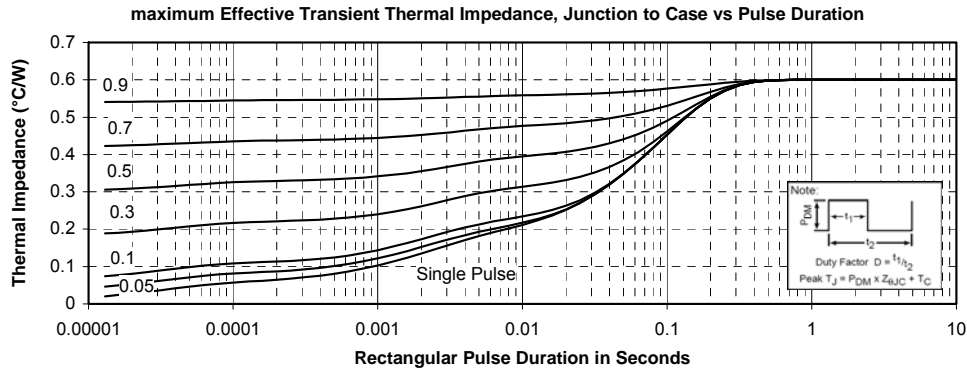
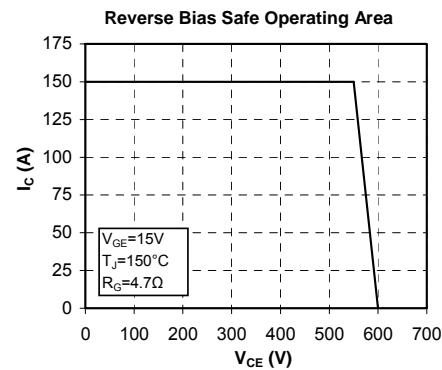
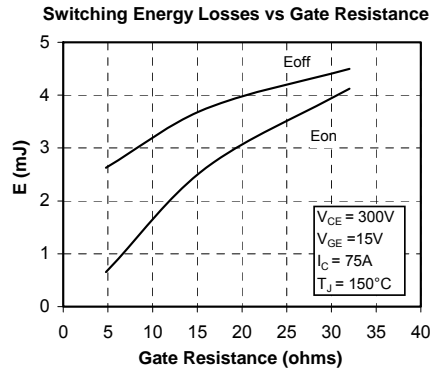
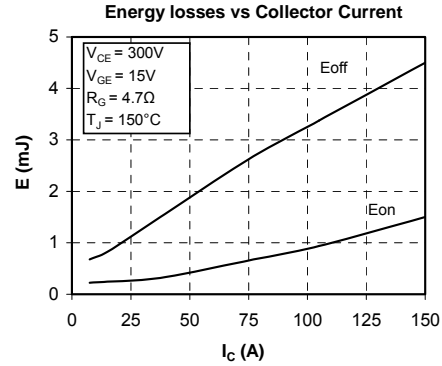
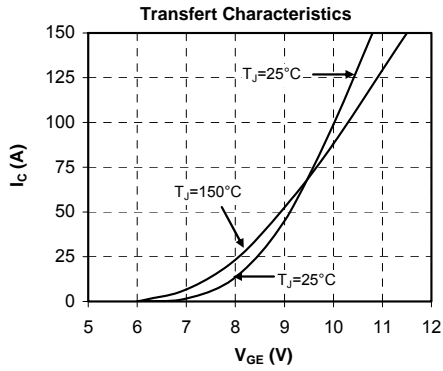
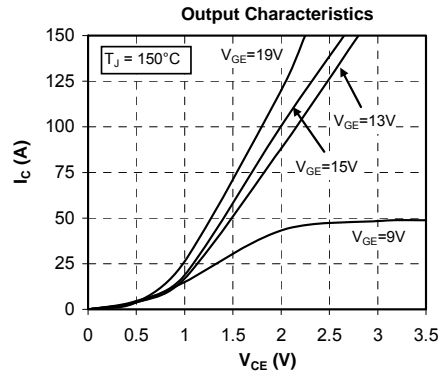
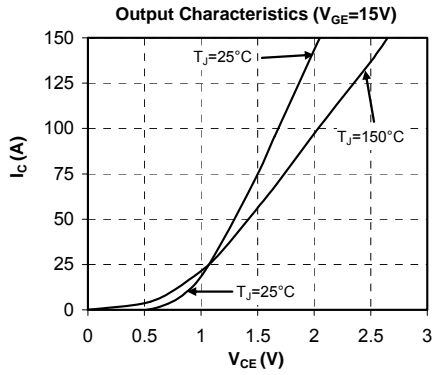

Q1 & Q4 Typical performance curve

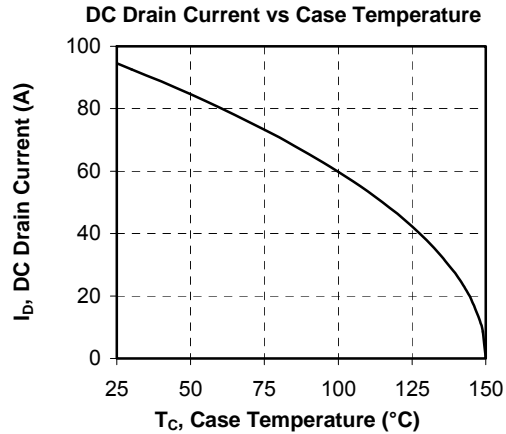
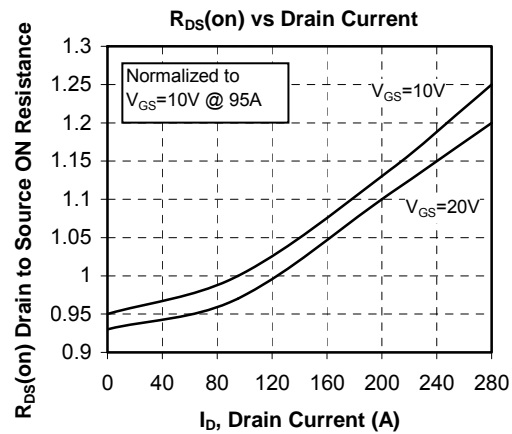
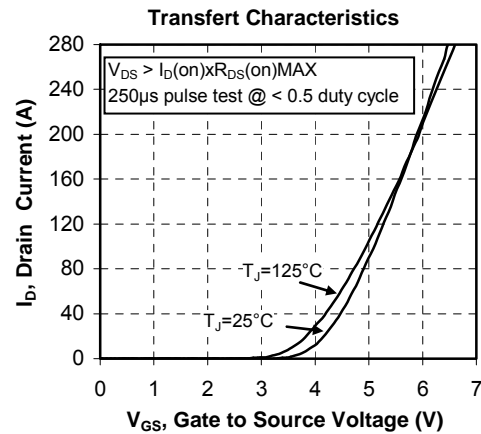
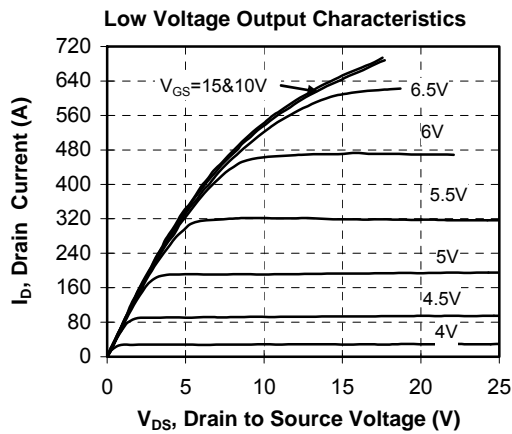
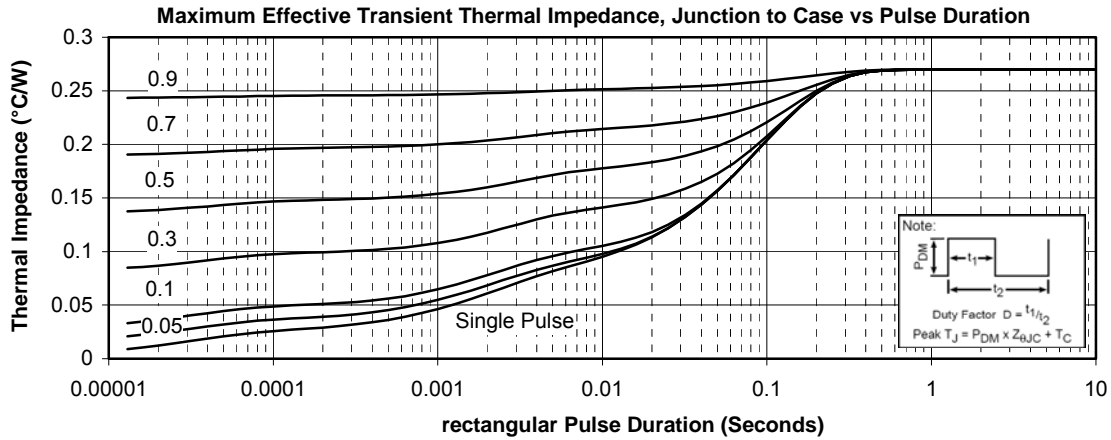

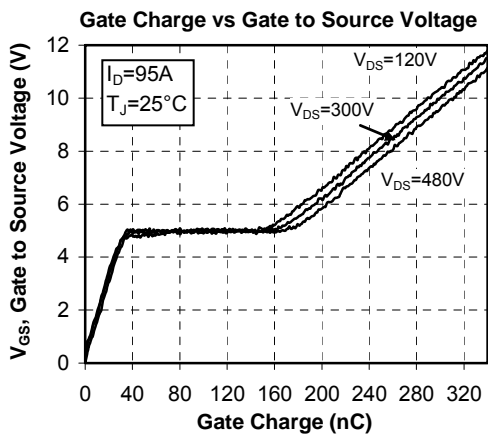
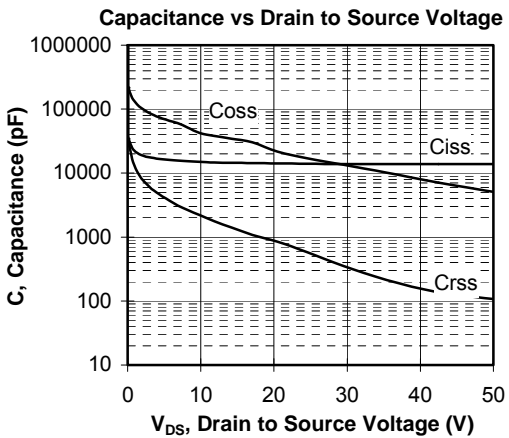
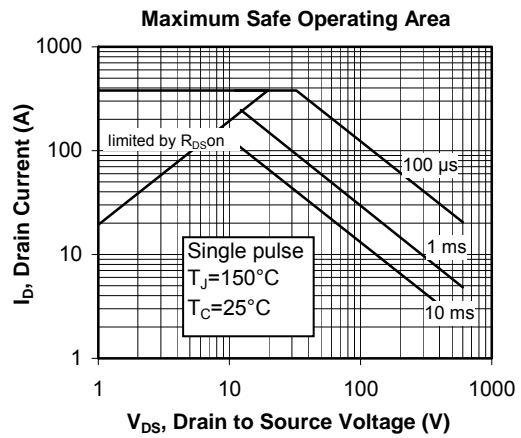
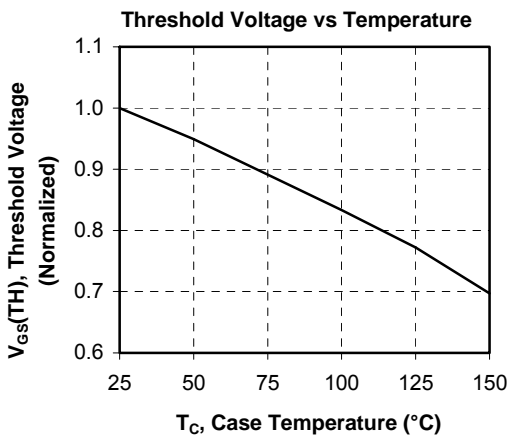
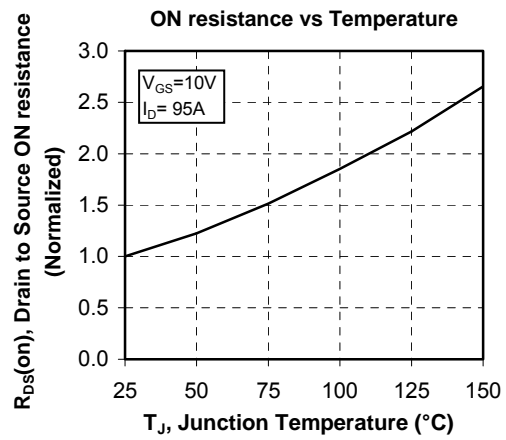
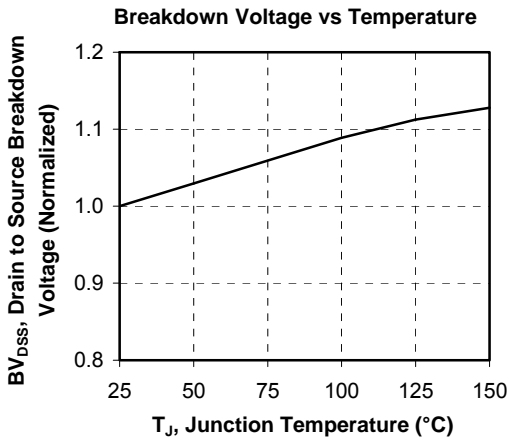

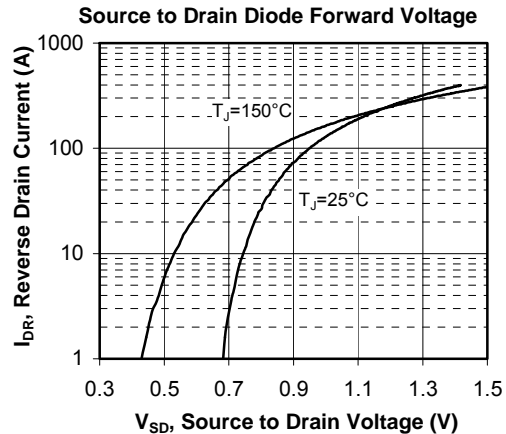
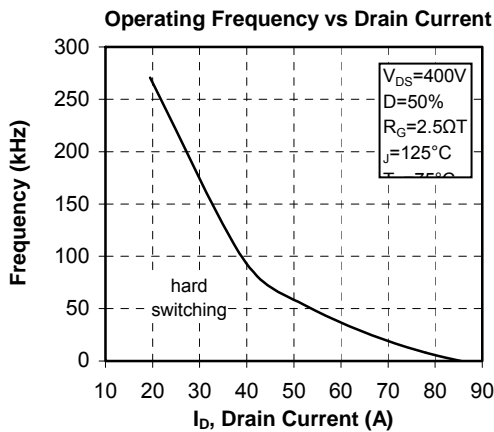
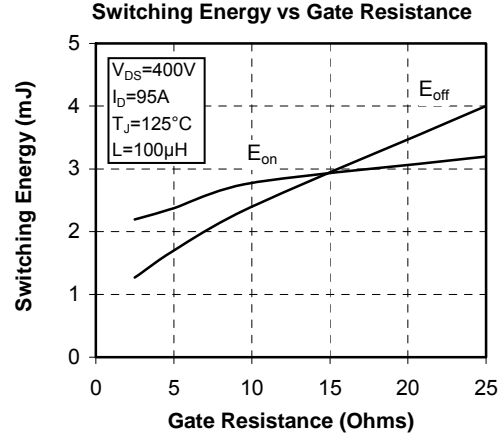
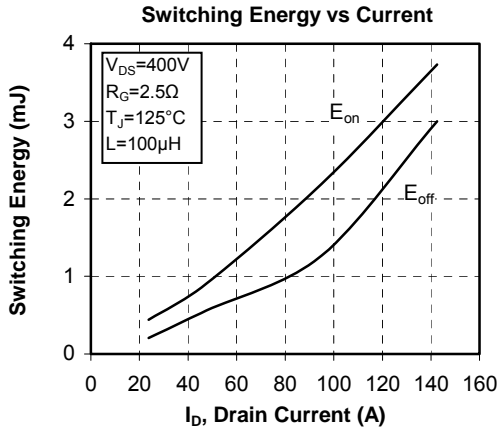
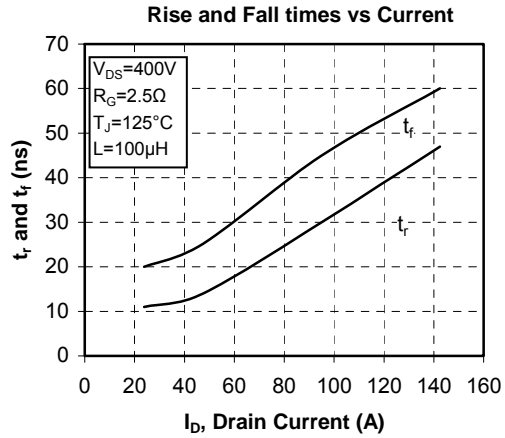
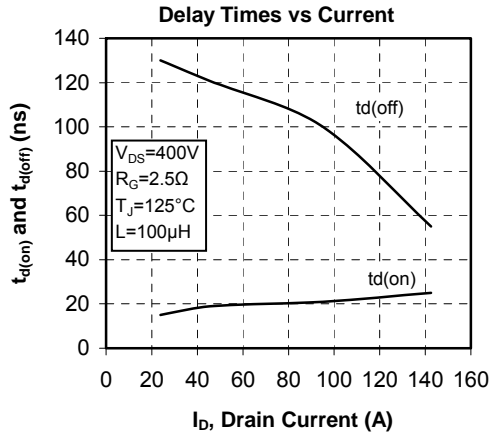

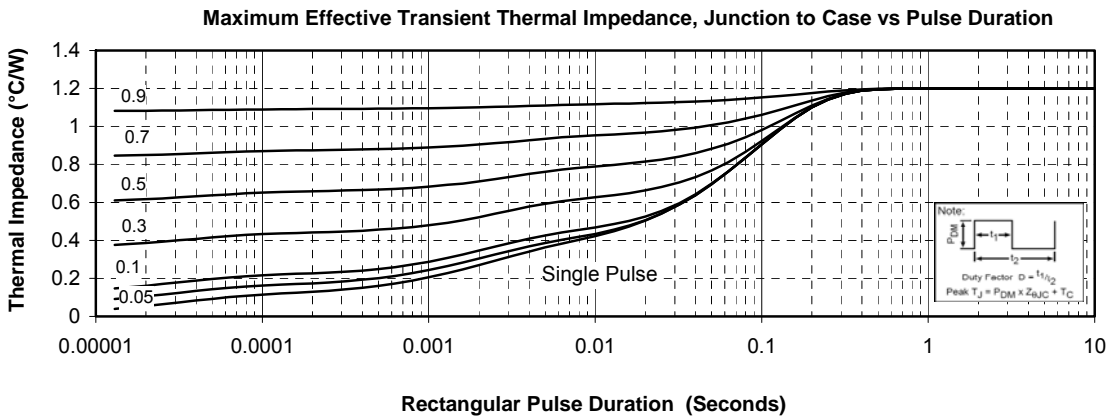
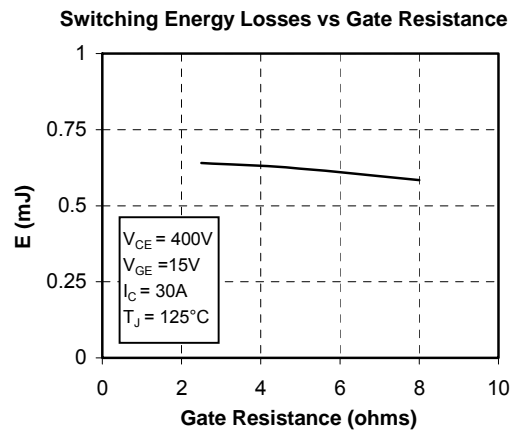
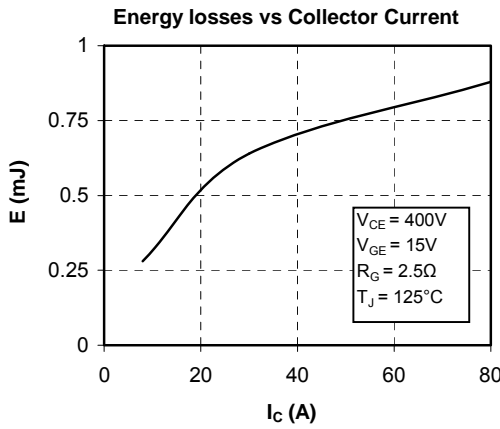
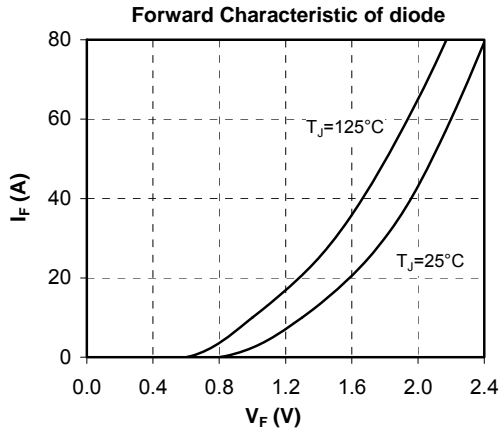
CR5 & CR6 Typical performance curve

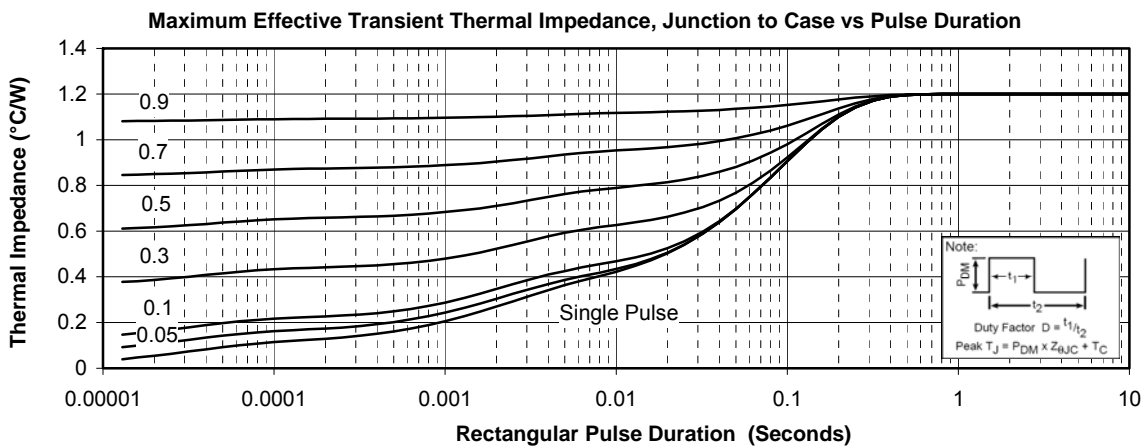
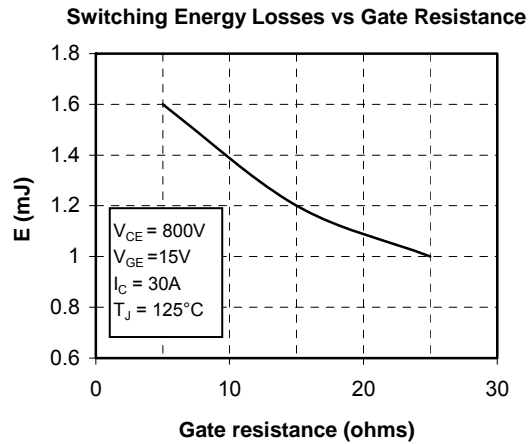
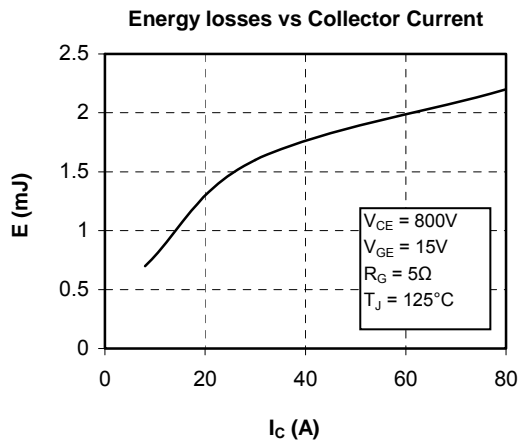
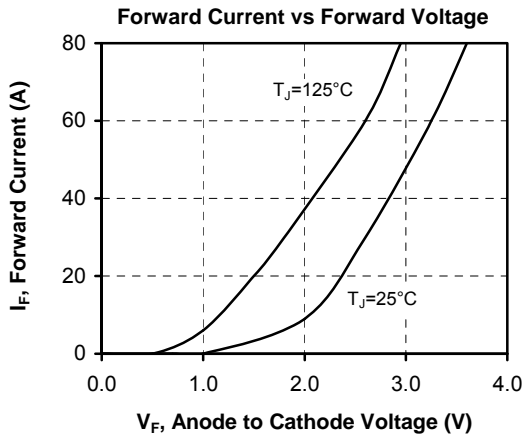
CR7 & CR8 Typical performance curve

CR2 & CR3 Typical performance curve

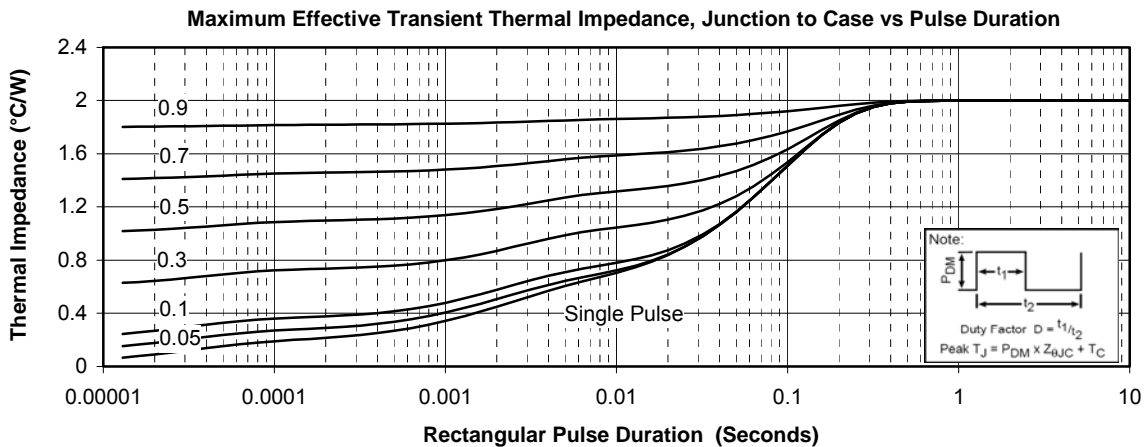
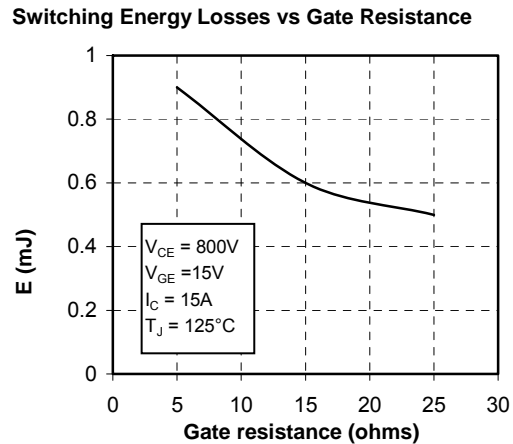
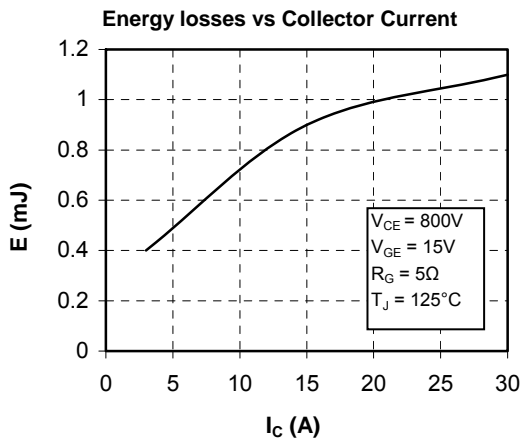
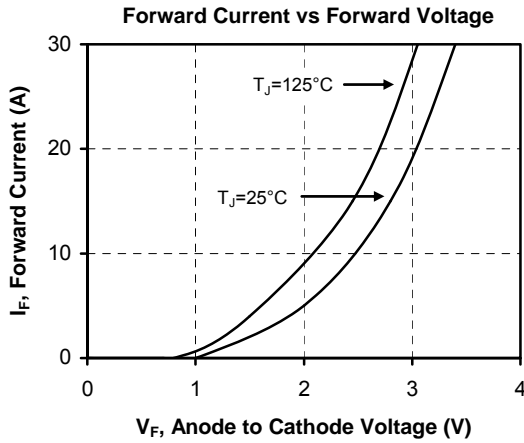

Microsemi reserves the right to change, without notice, the specifications and information contained herein

Microsemi's products are covered by one or more of U.S. patents 4,895,810 5,045,903 5,089,434 5,182,234 5,019,522 5,262,336 6,503,786 5,256,583 4,748,103 5,283,202 5,231,474 5,434,095 5,528,058 6,939,743 7,352,045 5,283,201 5,801,417 5,648,283 7,196,634 6,664,594 7,157,886 6,939,743 7,342,262 and foreign patents. U.S. and Foreign patents pending. All Rights Reserved.