

**ISOTOP[®] Buck chopper
Trench + Field Stop IGBT4
Power module**

**$V_{CES} = 1200V$
 $I_C = 60A @ T_c = 80^{\circ}C$**

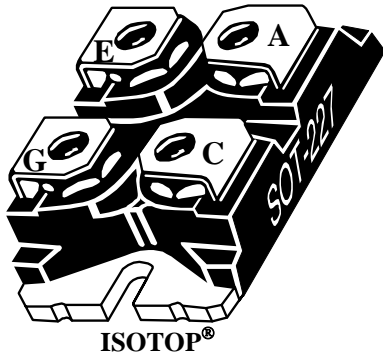
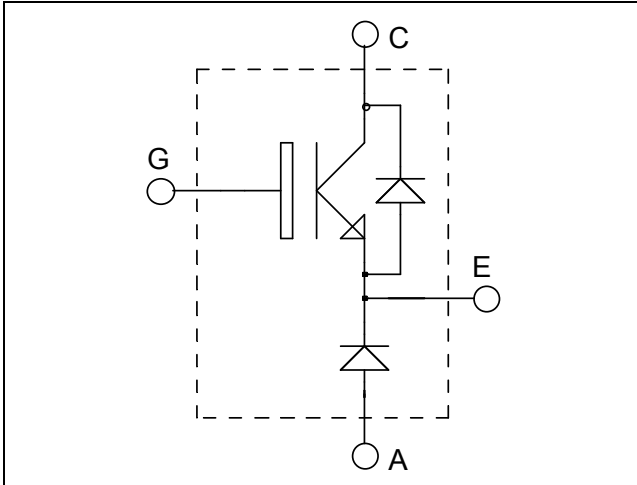

Application

- AC and DC motor control
- Switched Mode Power Supplies

Features

- Trench + Field Stop IGBT 4 Technology
 - Low voltage drop
 - Low leakage current
 - Low switching losses
 - Soft recovery parallel diodes
 - Low diode VF
 - Low leakage current
 - RBSOA and SCSOA rated
- ISOTOP[®] Package (SOT-227)
- Very low stray inductance
- High level of integration

Benefits

- Low conduction losses
- Stable temperature behavior
- Very rugged
- Direct mounting to heatsink (isolated package)
- Low junction to case thermal resistance
- Easy paralleling due to positive T_C of V_{CEsat}
- RoHS Compliant

Absolute maximum ratings

Symbol	Parameter	Max ratings	Unit
V_{CES}	Collector - Emitter Breakdown Voltage	1200	V
I_C	Continuous Collector Current	$T_C = 25^{\circ}C$	80
		$T_C = 80^{\circ}C$	60
I_{CM}	Pulsed Collector Current	$T_C = 25^{\circ}C$	100
V_{GE}	Gate - Emitter Voltage	± 20	V
P_D	Maximum Power Dissipation	$T_C = 25^{\circ}C$	280
RBSOA	Reverse Bias Safe Operating Area	$T_j = 150^{\circ}C$	100A @ 1100V

CAUTION: These Devices are sensitive to Electrostatic Discharge. Proper Handling Procedures Should Be Followed. See application note APT0502 on www.microsemi.com

All ratings @ $T_j = 25^\circ\text{C}$ unless otherwise specified

Electrical Characteristics

Symbol	Characteristic	Test Conditions	Min	Typ	Max	Unit
I_{CES}	Zero Gate Voltage Collector Current	$V_{GE} = 0V, V_{CE} = 1200V$			250	μA
$V_{CE(sat)}$	Collector Emitter saturation Voltage	$V_{GE} = 15V$ $I_C = 50A$	$T_j = 25^\circ\text{C}$	1.85	2.25	V
			$T_j = 150^\circ\text{C}$	2.25		
$V_{GE(th)}$	Gate Threshold Voltage	$V_{GE} = V_{CE}, I_C = 1.6mA$	5.0	5.8	6.5	V
I_{GES}	Gate – Emitter Leakage Current	$V_{GE} = 20V, V_{CE} = 0V$			400	nA

Dynamic Characteristics

Symbol	Characteristic	Test Conditions	Min	Typ	Max	Unit
C_{ies}	Input Capacitance	$V_{GE} = 0V$		2770		pF
C_{oes}	Output Capacitance	$V_{CE} = 25V$		205		
C_{res}	Reverse Transfer Capacitance	$f = 1MHz$		160		
Q_G	Gate charge	$V_{GE} = \pm 15V; V_{CE} = 600V$ $I_C = 50A$		0.38		μC
$T_{d(on)}$	Turn-on Delay Time	Inductive Switching (25°C)		130		ns
T_r	Rise Time	$V_{GE} = \pm 15V$ $V_{CE} = 600V$		20		
$T_{d(off)}$	Turn-off Delay Time	$I_C = 50A$		300		
T_f	Fall Time	$R_G = 8.2\Omega$		45		
$T_{d(on)}$	Turn-on Delay Time	Inductive Switching (150°C)		150		ns
T_r	Rise Time	$V_{GE} = \pm 15V$ $V_{CE} = 600V$		35		
$T_{d(off)}$	Turn-off Delay Time	$I_C = 50A$		350		
T_f	Fall Time	$R_G = 8.2\Omega$		80		
E_{on}	Turn-on Switching Energy	$V_{GE} = \pm 15V$ $V_{CE} = 600V$	$T_j = 25^\circ\text{C}$	3.8		mJ
			$T_j = 150^\circ\text{C}$	5.5		
E_{off}	Turn-off Switching Energy	$I_C = 50A$ $R_G = 8.2\Omega$	$T_j = 25^\circ\text{C}$	2.5		mJ
			$T_j = 150^\circ\text{C}$	4.5		
I_{sc}	Short Circuit data	$V_{GE} \leq 15V; V_{Bus} = 900V$ $t_p \leq 10\mu\text{s}; T_j = 150^\circ\text{C}$		200		A

Chopper diode ratings and characteristics

Symbol	Characteristic	Test Conditions	Min	Typ	Max	Unit
V_{RRM}	Maximum Peak Repetitive Reverse Voltage		1200			V
I_{RM}	Maximum Reverse Leakage Current	$V_R = 1200V$	$T_j = 25^\circ\text{C}$		100	μA
			$T_j = 125^\circ\text{C}$		500	
I_F	DC Forward Current			30		A
V_F	Diode Forward Voltage	$I_F = 30A$		2.6	3.1	V
		$I_F = 60A$		3.2		
		$I_F = 30A$	$T_j = 125^\circ\text{C}$	1.8		
t_{rr}	Reverse Recovery Time	$I_F = 30A$ $V_R = 800V$	$T_j = 25^\circ\text{C}$	300		ns
			$T_j = 125^\circ\text{C}$	380		
Q_{rr}	Reverse Recovery Charge	$di/dt = 200A/\mu\text{s}$	$T_j = 25^\circ\text{C}$	360		nC
			$T_j = 125^\circ\text{C}$	1700		

Thermal and package characteristics

Symbol	Characteristic	Min	Typ	Max	Unit
R _{thJC}	Junction to Case Thermal Resistance	IGBT		0.53	°C/W
		Diode		1.2	
R _{thJA}	Junction to Ambient (IGBT & Diode)			20	
V _{ISOL}	RMS Isolation Voltage, any terminal to case t=1 min, I _{isol} <1mA, 50/60Hz	2500			V
T _J , T _{STG}	Storage Temperature Range	-55		175	°C
T _L	Max Lead Temp for Soldering: 0.063" from case for 10 sec			300	
Torque	Mounting torque (Mounting = 8-32 or 4mm Machine and terminals = 4mm Machine)			1.5	N.m
Wt	Package Weight		29.2		g

SOT-227 (ISOTOP®) Package Outline

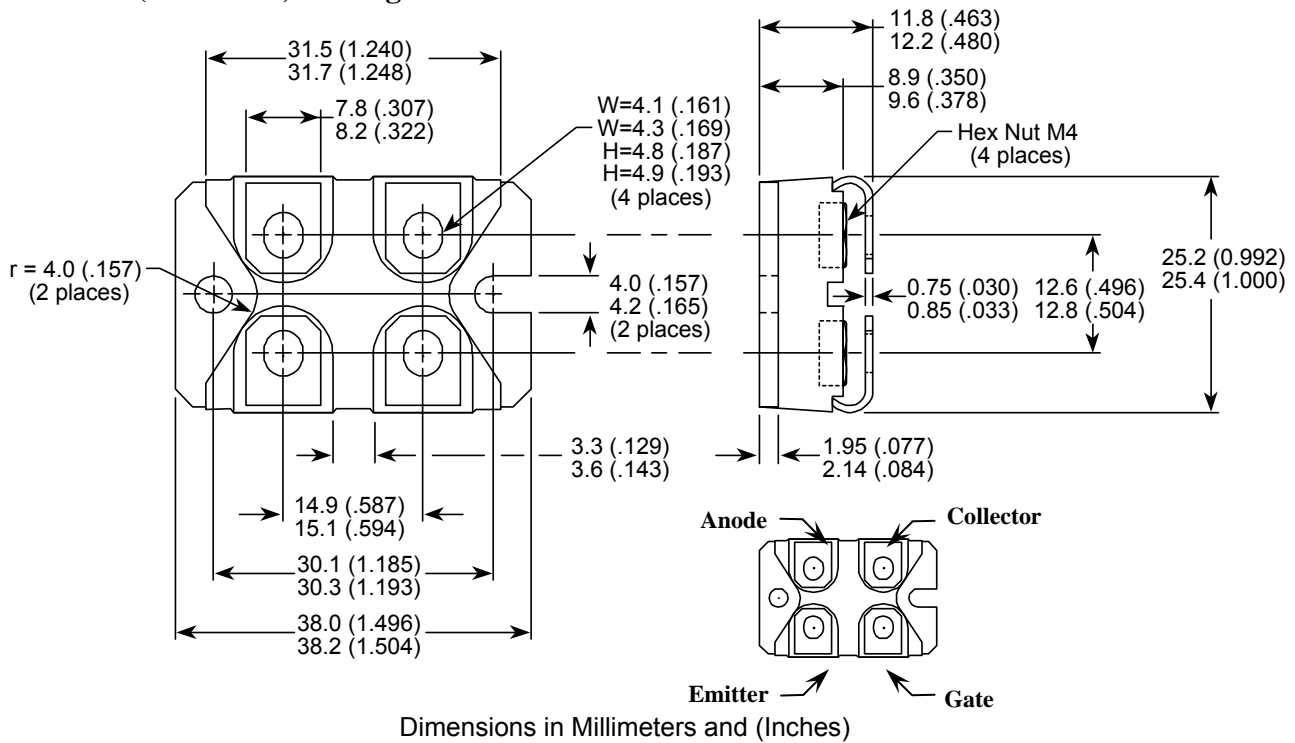

ISOTOP® is a registered trademark of ST Microelectronics NV

Typical Performance Curve

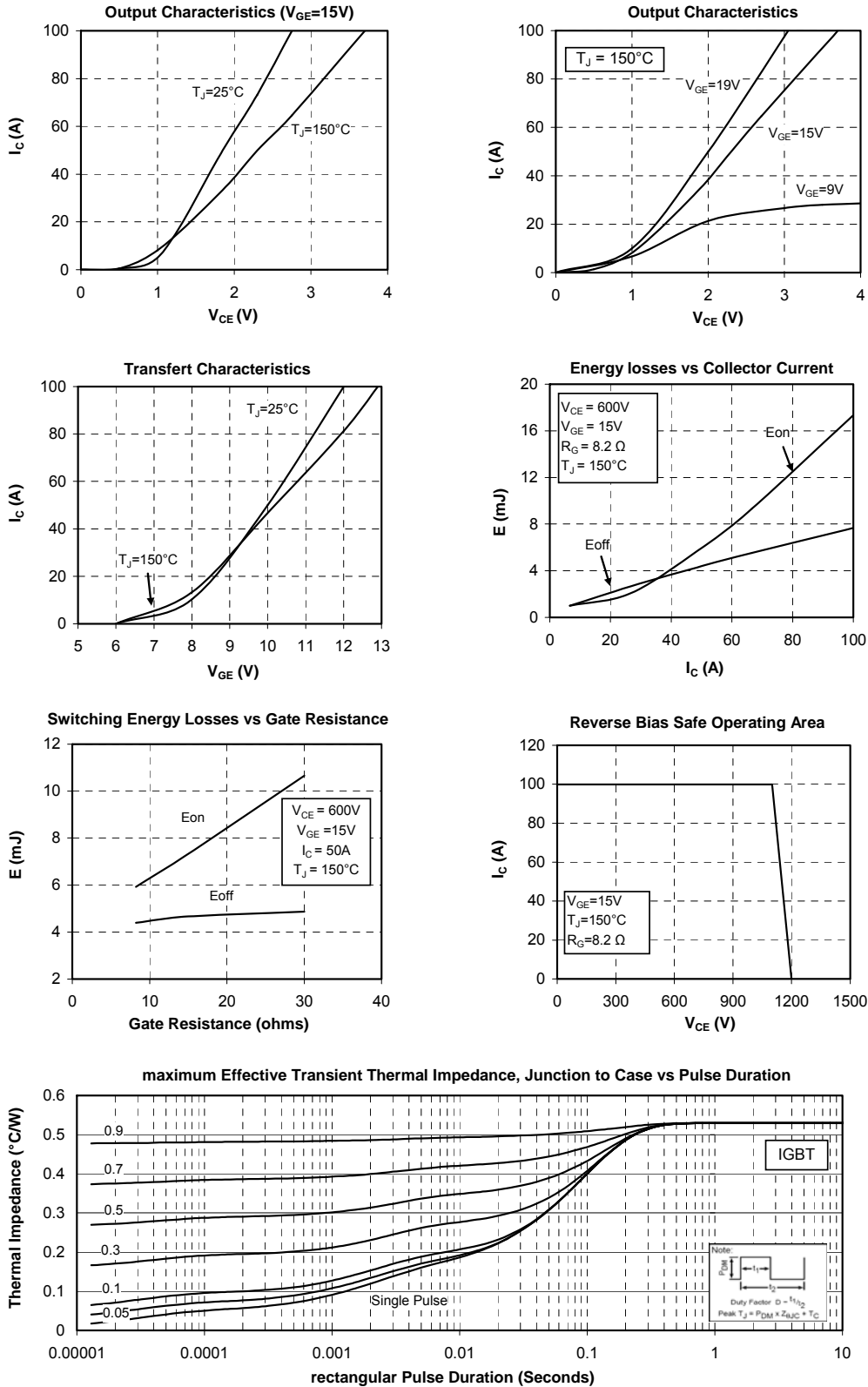

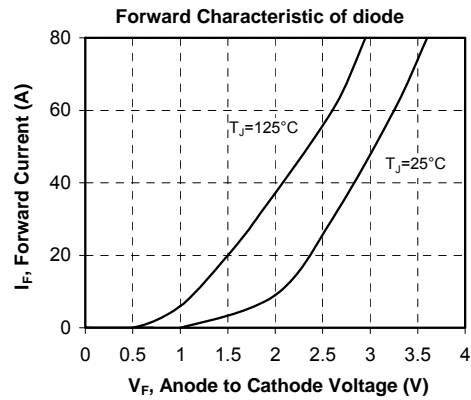
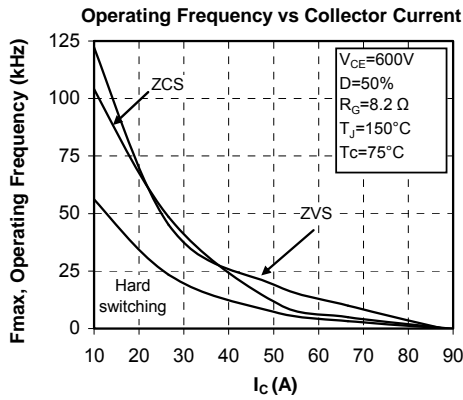

maximum Effective Transient Thermal Impedance, Junction to Case vs Pulse Duration

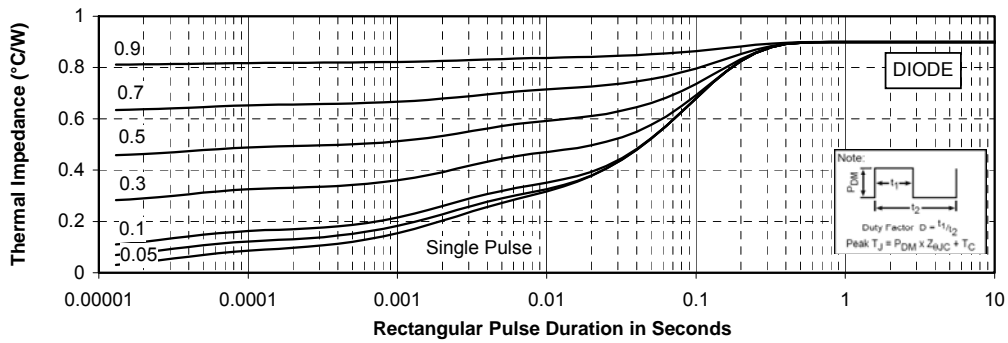

Microsemi reserves the right to change, without notice, the specifications and information contained herein

Microsemi's products are covered by one or more of U.S. patents 4,895,810 5,045,903 5,089,434 5,182,234 5,019,522 5,262,336 6,503,786 5,256,583 4,748,103 5,283,202 5,231,474 5,434,095 5,528,058 6,939,743 7,352,045 5,283,201 5,801,417 5,648,283 7,196,634 6,664,594 7,157,886 6,939,743 7,342,262 and foreign patents. U.S and Foreign patents pending. All Rights Reserved.