

**Boost chopper
NPT IGBT Power Module
Power Module**

**$V_{CES} = 600V$
 $I_C = 90A @ T_c = 100^\circ C$**

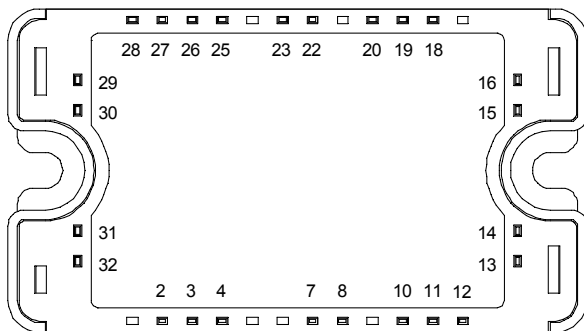
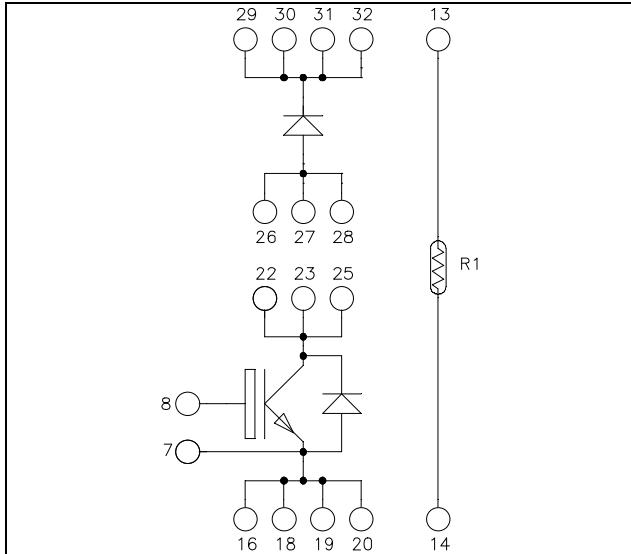

Pins 29/30/31/32 must be shorted together
 Pins 26/27/28/22/23/25 must be shorted together
 to achieve a phase leg
 Pins 16/18/19/20 must be shorted together

Application

- AC and DC motor control
- Switched Mode Power Supplies
- Power Factor Correction

Features

- Non Punch Through (NPT) Fast IGBT
 - Low voltage drop
 - Low tail current
 - Switching frequency up to 100 kHz
 - Soft recovery parallel diodes
 - Low diode VF
 - Low leakage current
 - RBSOA and SCSOA rated
- Very low stray inductance
- Kelvin emitter for easy drive
- Internal thermistor for temperature monitoring
- High level of integration
- AIN substrate for improved thermal performance

Benefits

- Direct mounting to heatsink (isolated package)
- Low junction to case thermal resistance
- Solderable terminals both for power and signal for easy PCB mounting
- Low profile
- RoHS Compliant

Absolute maximum ratings

| Symbol | Parameter | Max ratings | Unit |
|-----------|---------------------------------------|---------------------|-------------|
| V_{CES} | Collector - Emitter Breakdown Voltage | 600 | V |
| I_C | Continuous Collector Current | $T_C = 25^\circ C$ | 130 |
| | | $T_C = 100^\circ C$ | 90 |
| I_{CM} | Pulsed Collector Current | $T_C = 25^\circ C$ | 200 |
| V_{GE} | Gate - Emitter Voltage | ± 20 | V |
| P_D | Maximum Power Dissipation | $T_C = 25^\circ C$ | 520 |
| RBSOA | Reverse Bias Safe Operating Area | $T_J = 150^\circ C$ | 200A @ 480V |

CAUTION: These Devices are sensitive to Electrostatic Discharge. Proper Handling Procedures Should Be Followed. See application note APT0502 on www.microsemi.com

All ratings @ $T_j = 25^\circ\text{C}$ unless otherwise specified

Electrical Characteristics

| Symbol | Characteristic | Test Conditions | Min | Typ | Max | Unit |
|---------------|--------------------------------------|--|---------------------------|-----|-----|---------------|
| I_{CES} | Zero Gate Voltage Collector Current | $V_{GE} = 0\text{V}, V_{CE} = 600\text{V}$ | | | 250 | μA |
| $V_{CE(sat)}$ | Collector Emitter Saturation Voltage | $V_{GE} = 15\text{V}$ $I_C = 100\text{A}$ | $T_j = 25^\circ\text{C}$ | 2 | 2.5 | V |
| | | | $T_j = 125^\circ\text{C}$ | 2.2 | | |
| $V_{GE(th)}$ | Gate Threshold Voltage | $V_{GE} = V_{CE}, I_C = 1.5\text{mA}$ | 4.5 | 5.5 | 6.5 | V |
| I_{GES} | Gate – Emitter Leakage Current | $V_{GE} = 20\text{V}, V_{CE} = 0\text{V}$ | | | 400 | nA |

Dynamic Characteristics

| Symbol | Characteristic | Test Conditions | Min | Typ | Max | Unit |
|--------------|------------------------------|---|---------------------------|-----|-----|------|
| C_{ies} | Input Capacitance | $V_{GE} = 0\text{V}; V_{CE} = 25\text{V}$ | | 4.3 | | nF |
| C_{res} | Reverse Transfer Capacitance | $f = 1\text{MHz}$ | | 0.4 | | |
| Q_G | Gate charge | $V_{GE} = 15\text{V}; V_{CE} = 300\text{V}$ $I_C = 100\text{A}$ | | 240 | | nC |
| $T_{d(on)}$ | Turn-on Delay Time | Inductive Switching (25°C) $V_{GE} = \pm 15\text{V}$ $V_{Bus} = 300\text{V}$ $I_C = 100\text{A}$ $R_G = 2.2\Omega$ | | 25 | | ns |
| T_r | Rise Time | | | 10 | | |
| $T_{d(off)}$ | Turn-off Delay Time | | | 130 | | |
| T_f | Fall Time | | | 20 | | |
| $T_{d(on)}$ | Turn-on Delay Time | Inductive Switching (125°C) $V_{GE} = \pm 15\text{V}$ $V_{Bus} = 300\text{V}$ $I_C = 100\text{A}$ $R_G = 2.2\Omega$ | | 25 | | ns |
| T_r | Rise Time | | | 11 | | |
| $T_{d(off)}$ | Turn-off Delay Time | | | 150 | | |
| T_f | Fall Time | | | 30 | | |
| E_{on} | Turn-on Switching Energy | $V_{GE} = \pm 15\text{V}$ $V_{Bus} = 300\text{V}$ $I_C = 100\text{A}$ $R_G = 2.2\Omega$ | $T_j = 125^\circ\text{C}$ | 1 | | mJ |
| E_{off} | Turn-off Switching Energy | | $T_j = 125^\circ\text{C}$ | 3 | | |
| I_{sc} | Short Circuit data | $V_{GE} \leq 15\text{V}; V_{Bus} = 360\text{V}$ $t_p \leq 10\mu\text{s}; T_j = 125^\circ\text{C}$ | | 450 | | A |

Chopper diode ratings and characteristics

| Symbol | Characteristic | Test Conditions | Min | Typ | Max | Unit |
|-----------|---|---|---------------------------|-----|-----|---------------|
| V_{RRM} | Maximum Peak Repetitive Reverse Voltage | | 600 | | | V |
| I_{RM} | Maximum Reverse Leakage Current | $V_R = 600\text{V}$ | $T_j = 25^\circ\text{C}$ | | 35 | μA |
| | | | $T_j = 125^\circ\text{C}$ | | 600 | |
| I_F | DC Forward Current | | $T_c = 100^\circ\text{C}$ | 60 | | A |
| V_F | Diode Forward Voltage | $I_F = 60\text{A}$ | | 1.8 | 2.2 | V |
| | | $I_F = 120\text{A}$ | | 2.2 | | |
| | | $I_F = 60\text{A}$ | $T_j = 125^\circ\text{C}$ | 1.5 | | |
| t_{rr} | Reverse Recovery Time | $I_F = 60\text{A}$ $V_R = 400\text{V}$ | $T_j = 25^\circ\text{C}$ | 25 | | ns |
| | | | $T_j = 125^\circ\text{C}$ | 160 | | |
| Q_{rr} | Reverse Recovery Charge | $di/dt = 400\text{A}/\mu\text{s}$ | $T_j = 25^\circ\text{C}$ | 70 | | nC |
| | | | $T_j = 125^\circ\text{C}$ | 960 | | |

Thermal and package characteristics

| Symbol | Characteristic | Min | Typ | Max | Unit | |
|-------------------|--|-------------|-----|------|------|-----|
| R _{thJC} | Junction to Case Thermal Resistance | IGBT | | 0.24 | °C/W | |
| | | Diode | | 0.52 | | |
| V _{ISOL} | RMS Isolation Voltage, any terminal to case t=1 min, I _{isol} <1mA, 50/60Hz | 2500 | | | V | |
| T _J | Operating junction temperature range | -40 | | 150 | °C | |
| T _{STG} | Storage Temperature Range | -40 | | 125 | | |
| T _C | Operating Case Temperature | -40 | | 100 | | |
| Torque | Mounting torque | To heatsink | M4 | 2.5 | 4.7 | N.m |
| Wt | Package Weight | | | | 110 | g |

Temperature sensor NTC (see application note APT0406 on www.microsemi.com for more information).

| Symbol | Characteristic | Min | Typ | Max | Unit |
|-----------------------------------|----------------------------|-----|------|-----|------|
| R ₂₅ | Resistance @ 25°C | | 50 | | kΩ |
| ΔR ₂₅ /R ₂₅ | | | 5 | | % |
| B _{25/85} | T ₂₅ = 298.15 K | | 3952 | | K |
| ΔB/B | T _C = 100°C | | 4 | | % |

$$R_T = \frac{R_{25}}{\exp\left[B_{25/85}\left(\frac{1}{T_{25}} - \frac{1}{T}\right)\right]}$$

T: Thermistor temperature
 R_T: Thermistor value at T

SP3 Package outline (dimensions in mm)

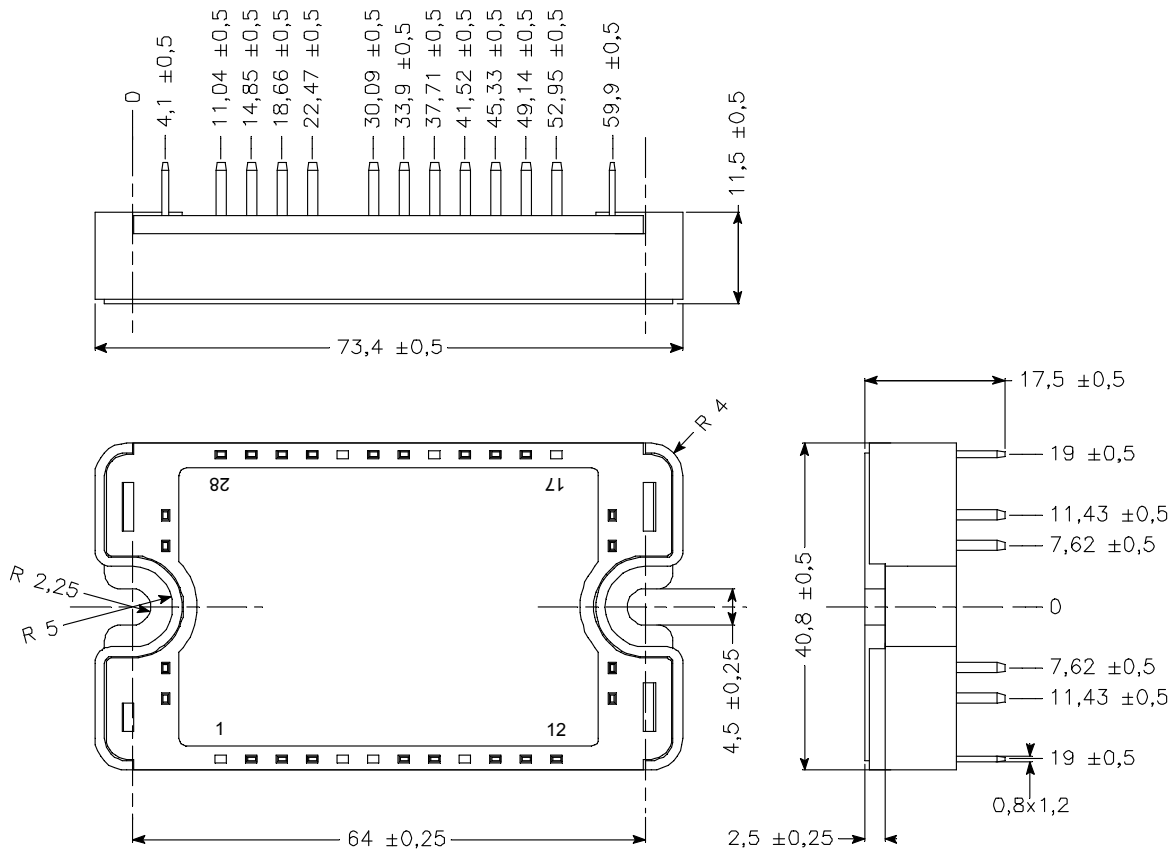

See application note 1901 - Mounting Instructions for SP3 Power Modules on www.microsemi.com

Typical Performance Curve

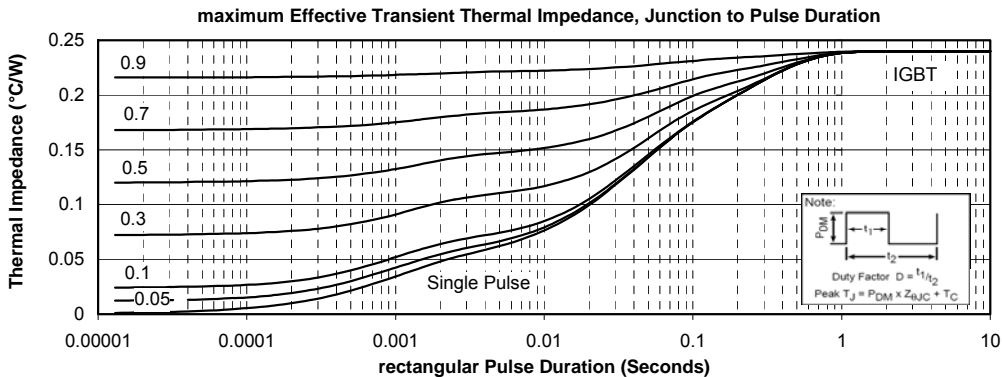
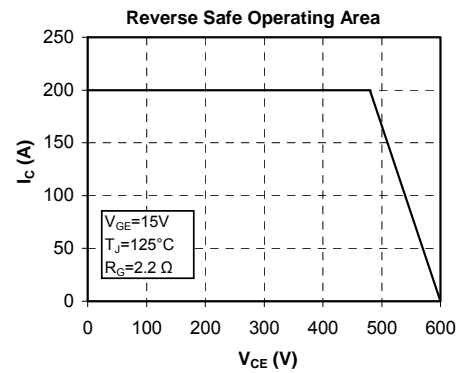
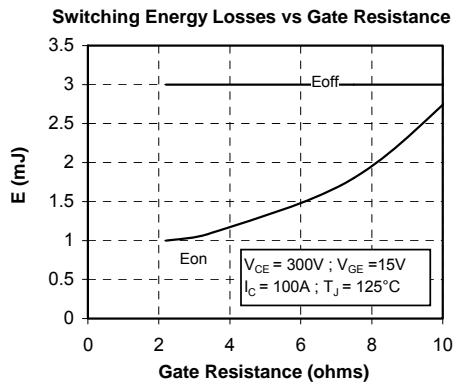
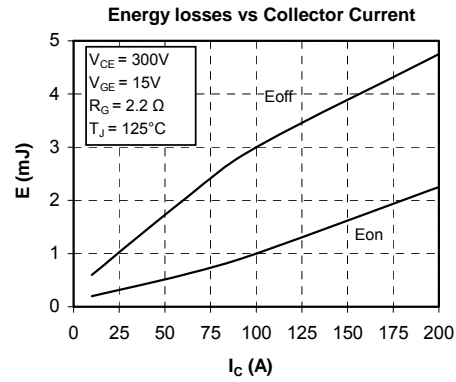
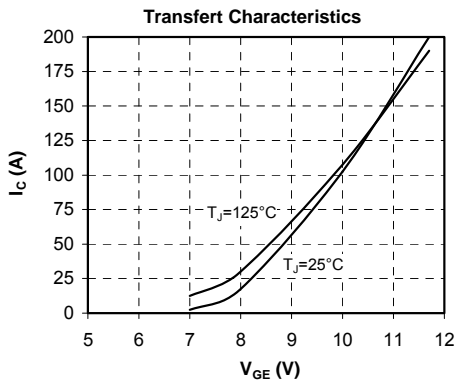
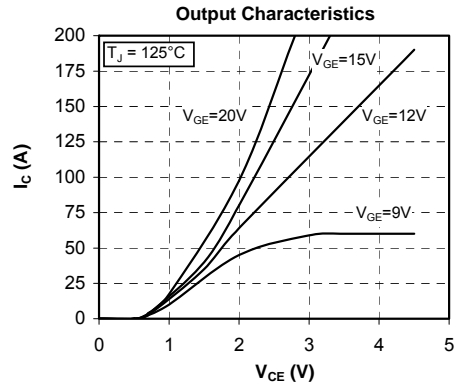
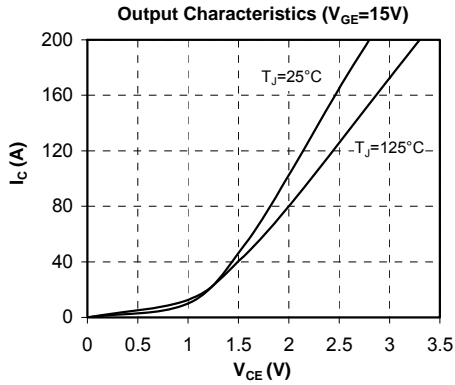

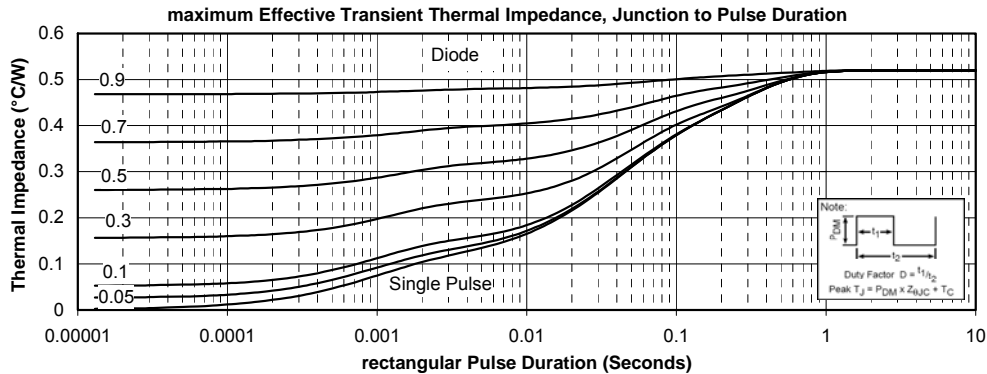
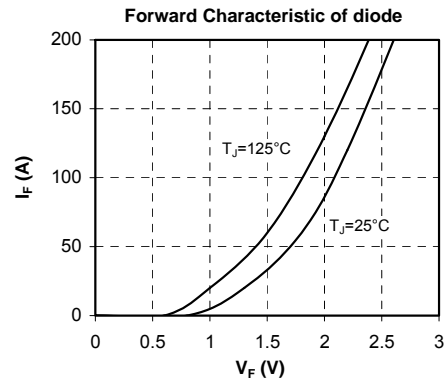
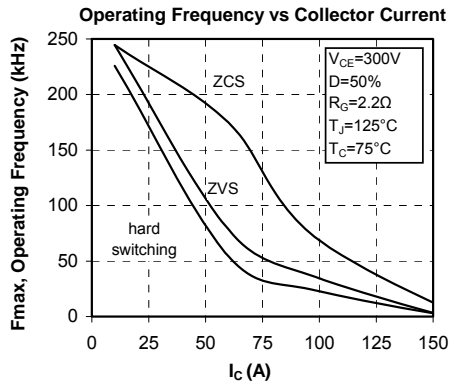

Microsemi reserves the right to change, without notice, the specifications and information contained herein

Microsemi's products are covered by one or more of U.S. patents 4,895,810 5,045,903 5,089,434 5,182,234 5,019,522 5,262,336 6,503,786 5,256,583 4,748,103 5,283,202 5,231,474 5,434,095 5,528,058 6,939,743 7,352,045 5,283,201 5,801,417 5,648,283 7,196,634 6,664,594 7,157,886 6,939,743 7,342,262 and foreign patents. U.S. and Foreign patents pending. All Rights Reserved.