

Features

- 150mA Low Dropout Regulator with EN
- Very low I_Q over full load: 65 μ A
- Wide input voltage range: 2V to 6V
- Wide adjustable output: 0.8V to 5.0V
- Fixed output options: 1.0V to 3.3V
- PSRR: 65dB at 100Hz
- Fast start-up time: 80 μ s
- Stable with low ESR, 1 μ F ceramic output capacitor
- Excellent Load/Line Transient Response
- Low dropout: 150mV typical at 150mA
- Current limit protection
- Short circuit protection
- Thermal shutdown protection
- Ambient temperature range: -40°C to 85°C
- SOT25: Available in "Green" Molding Compound (No Br, Sb)
- Lead Free Finish/RoHS Compliant (Note 1)

Description

The AP7311 is a 150mA, adjustable and fixed output voltage, low dropout linear regulator. The device included pass element, error amplifier, band-gap, current limit and thermal shutdown circuitry. The device is turned on when EN pin is set to logic high level.

The characteristics of low dropout voltage and low quiescent current make it suitable for low power applications, for example, battery powered devices. The typical quiescent current is approximately 65 μ A.

Built-in current-limit and thermal-shutdown functions prevent IC from damage in fault conditions.

The AP7311 is available in SOT25 package.

Applications

- Notebook and Desktop Computers and Pheripherals
- Portable Devices
- Battery Powered Devices
- CD-ROM, DVD and LAN Cards

Typical Application Circuit

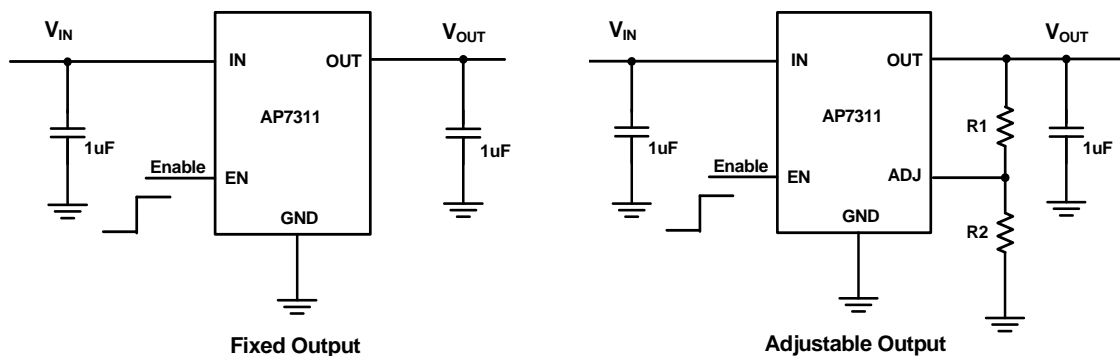

$$V_{OUT} = V_{REF} \left(1 + \frac{R_1}{R_2} \right)$$

Ordering Information

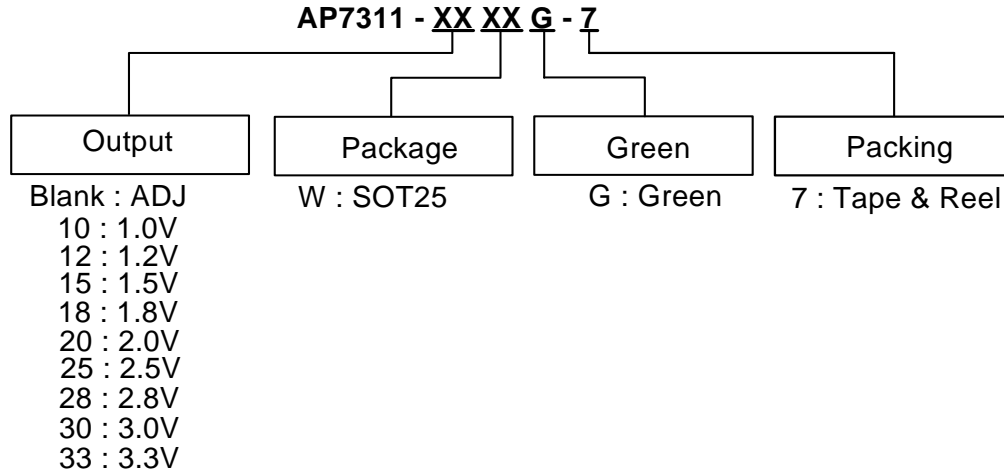

| Device | Package Code | Packaging (Note 2) | 7" Tape and Reel | |
|---|--------------|--------------------|------------------|--------------------|
| | | | Quantity | Part Number Suffix |
|  AP7311-XXWG-7 | W | SOT25 | 3000/Tape & Reel | -7 |

- Notes:
1. EU Directive 2002/95/EC (RoHS). All applicable RoHS exemptions applied. Please visit our website at http://www.diodes.com/products/lead_free.html
 2. Pad layout as shown on Diodes Inc. suggested pad layout document AP02001, which can be found on our website at <http://www.diodes.com/datasheets/ap02001.pdf>.

Pin Assignment

(1) SOT25 (Fixed Output)

(2) SOT25 (Adj Output)

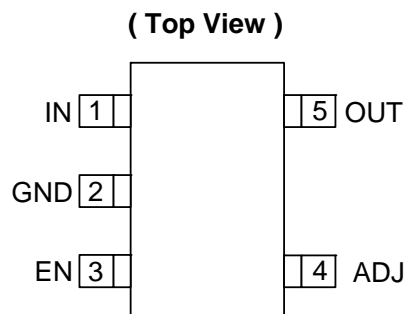
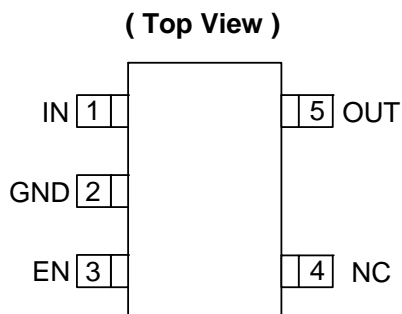

Pin Descriptions

| Pin Name | Pin Number | | Description |
|----------|---------------|-------------|--|
| | SOT25 (fixed) | SOT25 (adj) | |
| IN | 1 | 1 | Voltage input pin. Bypass to ground through at least 1 μ F capacitor |
| GND | 2 | 2 | Ground |
| EN | 3 | 3 | Enable input, active high |
| ADJ | - | 4 | Output feedback pin |
| NC | 4 | - | No connection |
| OUT | 5 | 5 | Voltage output pin. Bypass to ground through 1 μ F ceramic capacitor |

Functional Block Diagram

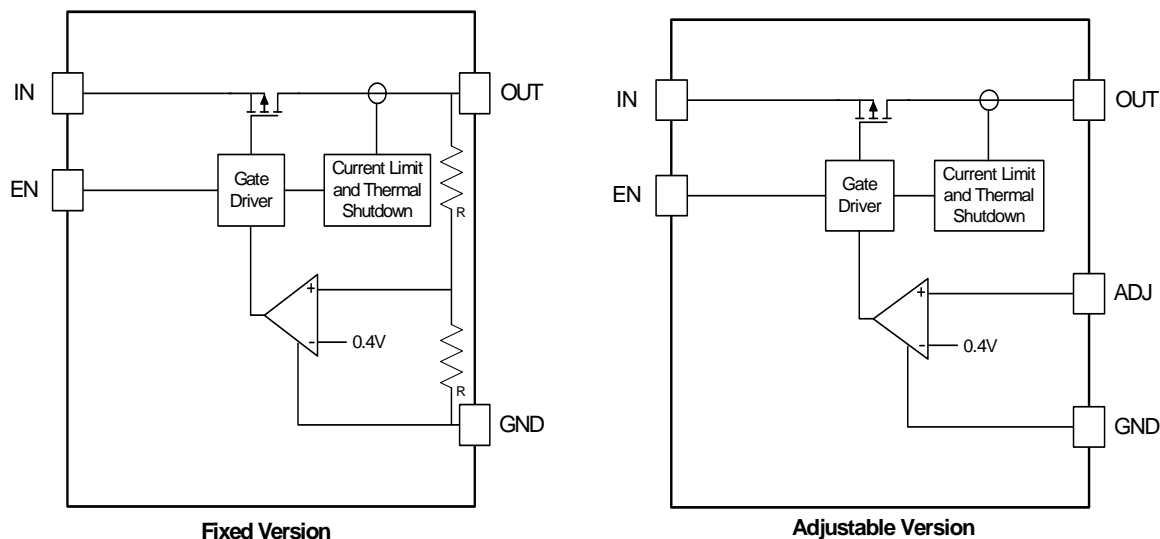

Absolute Maximum Ratings

| Symbol | Parameter | Ratings | Units |
|----------|--------------------------------------|------------------|-------|
| ESD HBM | Human Body Model ESD Protection | 6 | kV |
| ESD MM | Machine Model ESD Protection | 400 | V |
| V_{IN} | Input Voltage | 7 | V |
| | EN Voltage | $V_{IN} + 0.3$ | V |
| | Continuous Load Current | Internal Limited | |
| T_{OP} | Operating Junction Temperature Range | -40 ~ 125 | °C |
| T_{ST} | Storage Temperature Range | -65 ~ 150 | °C |
| P_D | Power Dissipation (Note 3) | SOT25 | 640 |
| T_J | Maximum Junction Temperature | 150 | °C |

Recommended Operating Conditions

| Symbol | Parameter | Min | Max | Unit |
|-----------|-------------------------------|-----|-----|------|
| V_{IN} | Input voltage | 2 | 6 | V |
| I_{OUT} | Output Current (Note 4) | 0 | 150 | mA |
| T_A | Operating Ambient Temperature | -40 | 85 | °C |

Notes: 3. Ratings apply to ambient temperature at 25°C
4. The device maintains a stable, regulated output voltage without a load current.

Electrical Characteristics

($T_A = 25^\circ\text{C}$, $V_{IN} = V_{OUT} + 1\text{V}$, $C_{IN} = 1\mu\text{F}$, $C_{OUT} = 1\mu\text{F}$, $V_{EN} = 2\text{V}$, unless otherwise stated)

| Symbol | Parameter | Test Conditions | Min | Typ. | Max | Unit |
|--|--|--|------|------|------|---------------------------|
| I_Q | Input Quiescent Current | $V_{EN} = V_{IN}$, $I_{OUT} = 0\text{mA}$ | — | 55 | 75 | μA |
| | | $V_{EN} = V_{IN}$, $I_{OUT} = 150\text{mA}$ | | 65 | 85 | |
| I_{SHDN} | Input Shutdown Current | $V_{EN} = 0\text{V}$, $I_{OUT} = 0\text{mA}$ | — | | 1 | μA |
| I_{LEAK} | Input Leakage Current | $V_{EN} = 0\text{V}$, I_{OUT} grounded | — | | 1 | μA |
| $V_{DROPOUT}$ | Dropout Voltage (Note 5) | $I_{OUT} = 150\text{mA}$ | | 150 | 300 | mV |
| V_{REF} | ADJ Reference Voltage (Adjustable version) | $I_{OUT} = 0\text{mA}$ | | 0.4 | | V |
| I_{ADJ} | ADJ Leakage (Adjustable version) | | — | | 1 | μA |
| V_{OUT} | Output Voltage Accuracy | $T_A = -40^\circ\text{C}$ to 85°C , $I_{OUT} = 30\text{mA}$ | -2 | | 2 | % |
| $\frac{\Delta V_{OUT}}{\Delta V_{IN}/V}$ | Line Regulation | $V_{IN} = (V_{OUT} + 1\text{V})$ to V_{IN-Max} , $V_{EN} = V_{IN}$, $I_{OUT} = 1\text{mA}$ | | 0.01 | 0.20 | %/V |
| $\frac{\Delta V_{OUT}}{I_{OUT}}$ | Load Regulation | $V_{IN} = (V_{OUT} + 1\text{V})$ to V_{IN-Max} , I_{OUT} from 1mA to 150mA | -0.6 | | 0.6 | % |
| t_{ST} | Start-up Time | $V_{EN} = 0\text{V}$ to 2.0V , $V_{OUT} = 1.8\text{V}$ $I_{OUT} = 150\text{mA}$ | | 80 | | μs |
| PSRR | PSRR | $V_{IN} = [V_{OUT} + 1\text{V}]V_{DC} + 0.5V_{ppAC}$, $f = 100\text{Hz}$, $I_{OUT} = 30\text{mA}$ | | 65 | | dB |
| I_{SHORT} | Short-circuit Current | $V_{IN} = V_{IN-Min}$ to V_{IN-Max} , $V_{OUT} < 0.2\text{V}$ | | 50 | | mA |
| I_{LIMIT} | Current Limit | $V_{IN} = (V_{OUT} + 1\text{V})$ to V_{IN-Max} , $V_{OUT}/R_{OUT} = 0.5\text{A}$ | 200 | 300 | | mA |
| V_{IL} | EN Input Logic Low Voltage | $V_{IN} = V_{IN-Min}$ to V_{IN-Max} | | | 0.4 | V |
| V_{IH} | EN Input Logic High Voltage | $V_{IN} = V_{IN-Min}$ to V_{IN-Max} | 1.4 | | | V |
| I_{EN} | EN Input Current | $V_{IN} = 0\text{V}$ or V_{IN-Max} | -1 | | 1 | μA |
| T_{SHDN} | Thermal Shutdown Threshold | | | 140 | | $^\circ\text{C}$ |
| T_{HYS} | Thermal Shutdown Hysteresis | | | 15 | | $^\circ\text{C}$ |
| θ_{JA} | Thermal Resistance Junction-to-Ambient | SOT25 (Note 6) | | 190 | | $^\circ\text{C}/\text{W}$ |

Notes: 5. Dropout voltage is the voltage difference between the input and the output at which the output voltage drops 2% below its nominal value. This parameter only applies to output voltages above 1.8V.
6. Test conditions for SOT25: Device mounted on FR-4 substrate PCB, with minimum recommended pad layout, 2oz copper, single sided

Typical Performance Characteristics

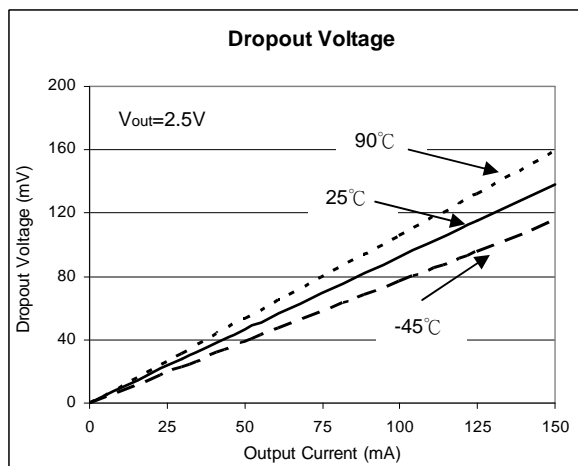
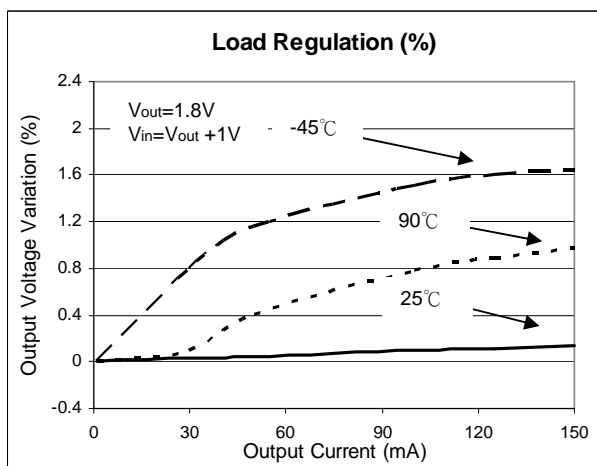
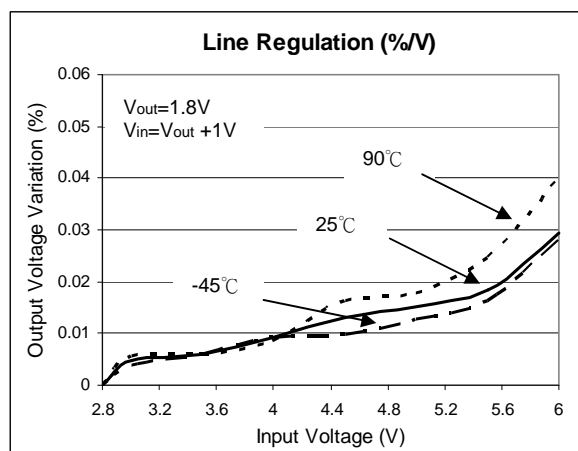
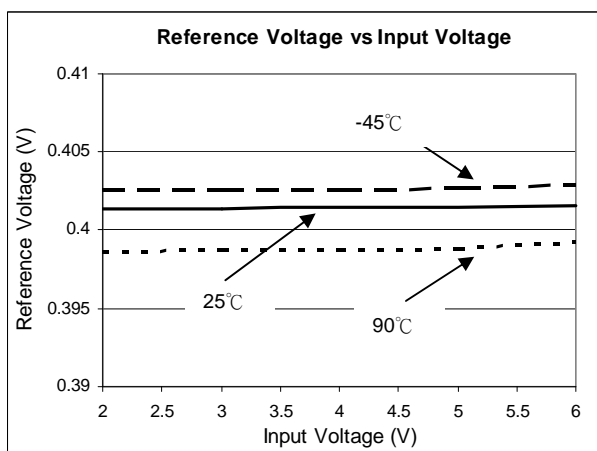
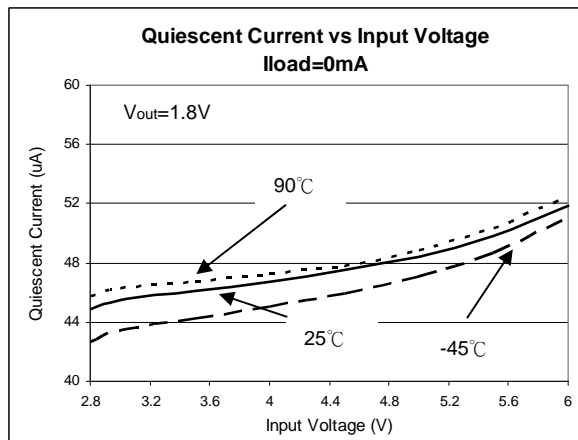
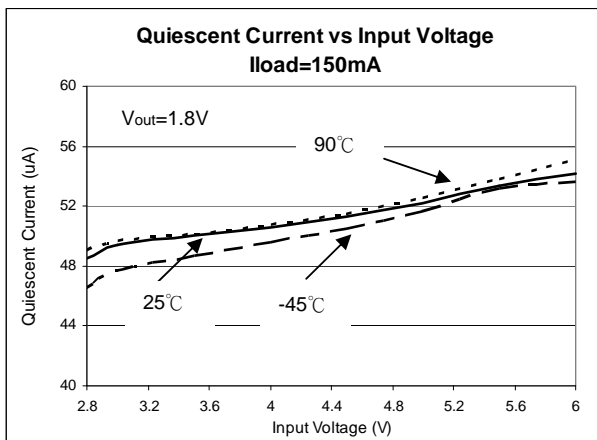

Typical Performance Characteristics (Continued)

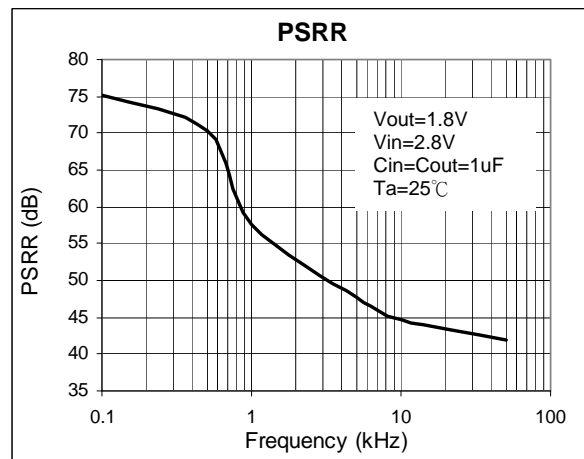
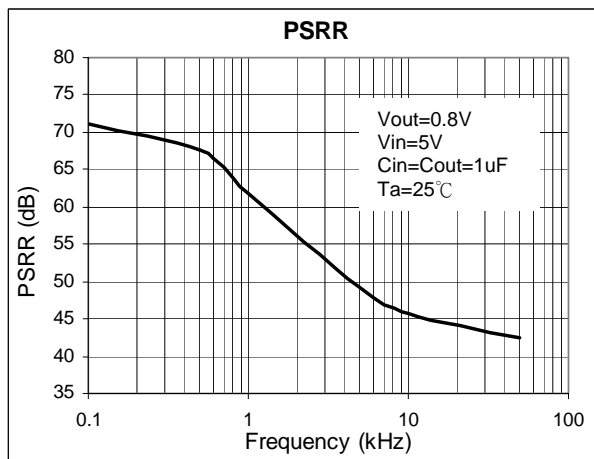
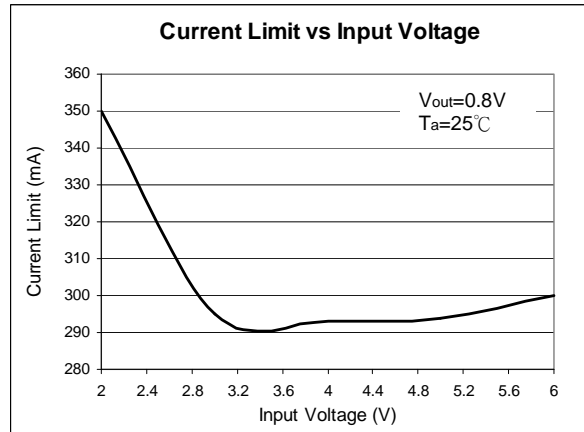
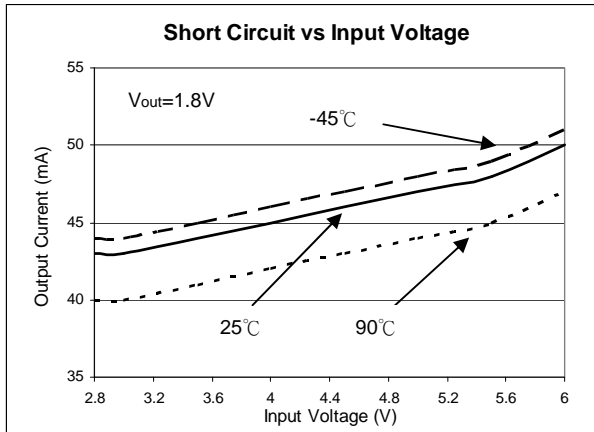

Typical Performance Characteristics (Continued)

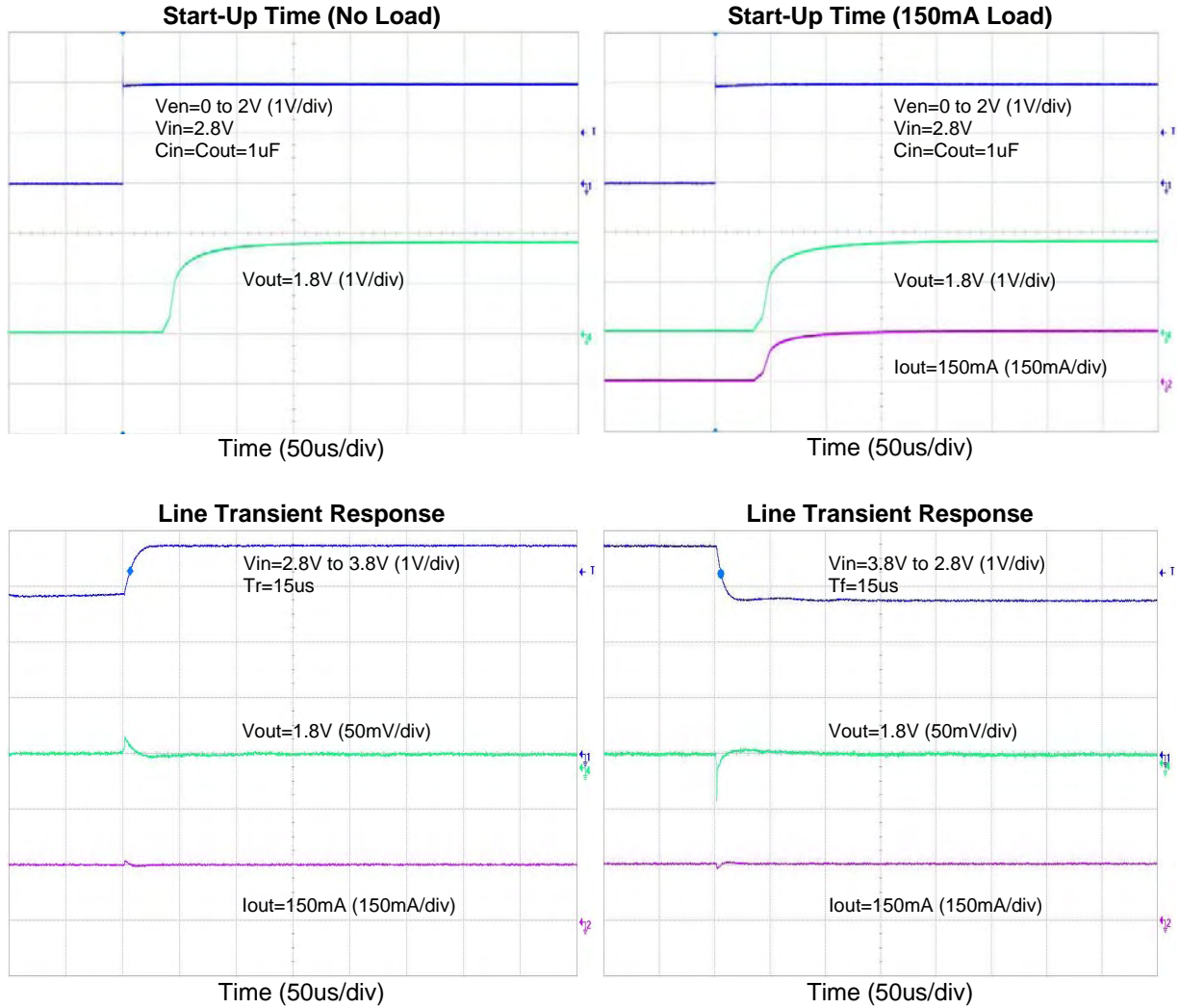

Typical Performance Characteristics (Continued)

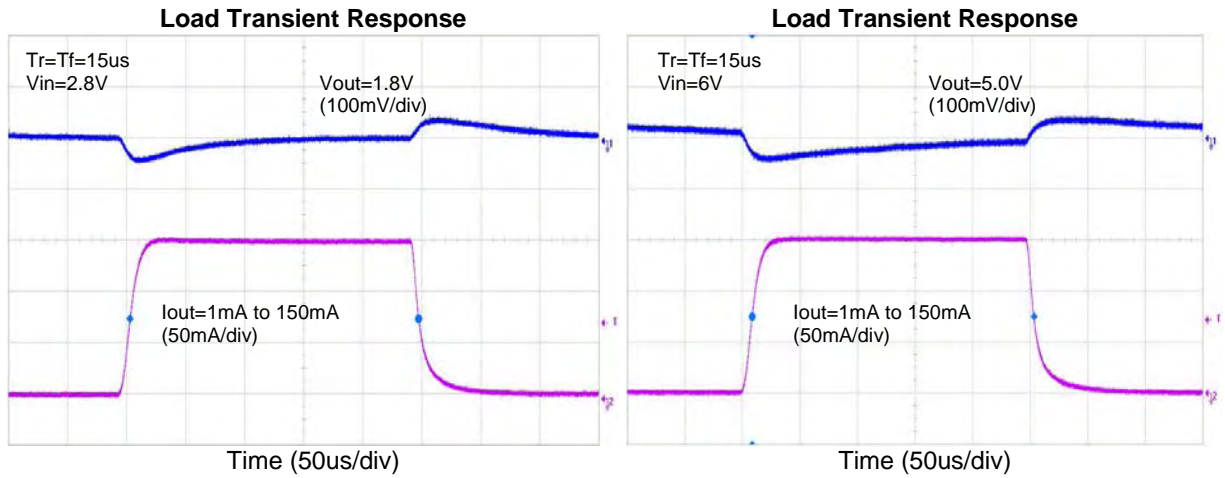

Application Note

Input Capacitor

A 1 μ F ceramic capacitor is recommended to connect between V_{IN} and GND pins to decouple input power supply glitch and noise. The amount of the capacitance may be increased without limit. This input capacitor must be located as close as possible to the device to assure input stability and less noise. For PCB layout, a wide copper trace is required for both V_{IN} and GND. A lower ESR capacitor allows the use of less capacitance, while higher ESR type requires more capacitance.

Output Capacitor

The output capacitor is required to stabilize and help transient response for LDO. The AP7311 is stable with very small ceramic output capacitors. The recommended capacitance is from 1 μ F to 4.7 μ F, Equivalent Series Resistance (ESR) is from 10m Ω to 200m Ω , and temperature characteristic is X7R or X5R. Higher capacitance values help to improve load/line transient response. The output capacitance may be increased to keep low undershoot/overshoot. Place output capacitor as close as possible to OUT and GND pins, and keep the leads as short as possible.

Adjustable Operation

The AP7311 provides output voltage from 0.8V to 5.0V through external resistor divider as shown below.

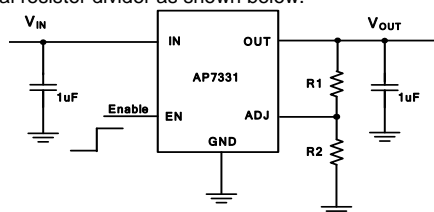

The output voltage is calculated by:

$$V_{OUT} = V_{REF} \left(1 + \frac{R_1}{R_2} \right)$$

Where $V_{REF}=0.4V$ (the internal reference voltage)

Rearranging the equation will give the following that is used for adjusting the output to a particular voltage:

$$R_1 = R_2 \left(\frac{V_{OUT}}{V_{REF}} - 1 \right)$$

To maintain the stability of the internal reference voltage, R_2 need to be kept smaller than 125k Ω .

No Load Stability

Other than external resistor divider, no minimum load is required to keep the device stable. The device will remain stable and regulated in no load condition.

ON/OFF Input Operation

The AP7311 is turned on by setting the EN pin high, and is turned off by pulling it low. If this feature is not used, the EN pin should be tied to IN pin to keep the regulator output on at all time. To ensure proper operation, the signal source used to drive the EN pin must be able to swing above and below the specified turn-on/off voltage thresholds listed in the Electrical

Characteristics section under V_{IL} and V_{IH} .

Current Limit Protection

When output current at OUT pin is higher than current limit threshold, the current limit protection will be triggered and clamp the output current to approximately 300mA to prevent over-current and to protect the regulator from damage due to overheating.

Short Circuit Protection

When OUT pin is short-circuit to GND or OUT pin voltage is less than 200mV, short circuit protection will be triggered and clamp the output current to approximately 50mA. This feature protects the regulator from over-current and damage due to overheating.

Thermal Shutdown Protection

Thermal protection disables the output when the junction temperature rises to approximately +140 $^{\circ}$ C, allowing the device to cool down. When the junction temperature reduces to approximately +125 $^{\circ}$ C the output circuitry is enabled again. Depending on power dissipation, thermal resistance, and ambient temperature, the thermal protection circuit may cycle on and off. This cycling limits the heat dissipation of the regulator, protecting it from damage due to overheating.

Ultra Fast Start-up

After enabled, the AP7311 is able to provide full power in as little as tens of microseconds, typically 80 μ s, without sacrificing low ground current. This feature will help load circuitry move in and out of standby mode in real time, eventually extend battery life for mobile phones and other portable devices.

Fast Transient Response

Fast transient response LDOs can extend battery life. TDMA-based cell phone protocols such as Global System for Mobile Communications (GSM) have a transmit/receive duty factor of only 12.5 percent, enabling power savings by putting much of the baseband circuitry into standby mode in between transmit cycles. In baseband circuits, the load often transitions virtually instantaneously from 100 μ A to 100mA. To meet this load requirement, the LDO must react very quickly without a large voltage drop or overshoot — a requirement that cannot be met with conventional, general-purpose LDOs.

The AP7311's fast transient response from 0 to 150mA provides stable voltage supply for fast DSP and GSM chipset with fast changing load.

Small Overshoot and Undershoot

The AP7311 has small and controlled overshoot and undershoot in load and line transitions. This helps to protect supplied circuit from damage and operation error caused by glitches. This feature also permits the usage of small value output decoupling capacitor with AP7311.

Low Quiescent Current

The AP7311, consuming only around 65 μ A for all input range and output loading, provides great power saving in portable and low power applications.

Wide Output Range

The AP7311, with a wide output range of 0.8V to 5.0V, provides a versatile LDO solution for many portable applications.

Marking Information

(1) SOT25

(Top View)

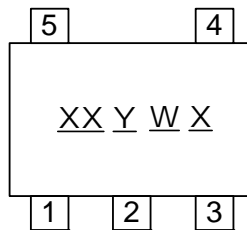

XX : Identification code
Y : Year 0~9
W : Week : A~Z : 1~26 week;
a~z : 27~52 week; z represents
52 and 53 week
X : A~Z : Green

| Device | Package | Identification Code |
|------------|---------|---------------------|
| AP7311-ADJ | SOT25 | RM |
| AP7311-10 | SOT25 | RN |
| AP7311-12 | SOT25 | RP |
| AP7311-15 | SOT25 | RR |
| AP7311-18 | SOT25 | RS |
| AP7311-20 | SOT25 | RT |
| AP7311-25 | SOT25 | RU |
| AP7311-28 | SOT25 | RV |
| AP7311-30 | SOT25 | RW |
| AP7311-33 | SOT25 | RX |

Package Information (All Dimensions in mm)

(1) Package Type: SOT25

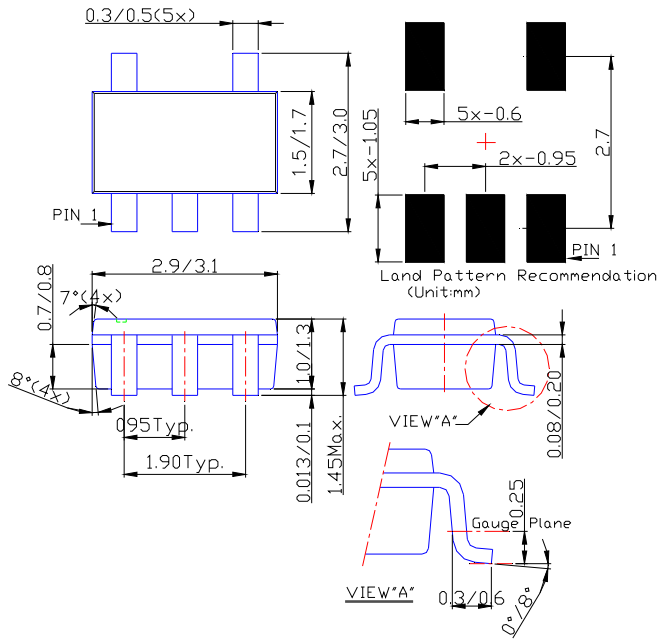

IMPORTANT NOTICE

DIODES INCORPORATED MAKES NO WARRANTY OF ANY KIND, EXPRESS OR IMPLIED, WITH REGARDS TO THIS DOCUMENT, INCLUDING, BUT NOT LIMITED TO, THE IMPLIED WARRANTIES OF MERCHANTABILITY AND FITNESS FOR A PARTICULAR PURPOSE (AND THEIR EQUIVALENTS UNDER THE LAWS OF ANY JURISDICTION).

Diodes Incorporated and its subsidiaries reserve the right to make modifications, enhancements, improvements, corrections or other changes without further notice to this document and any product described herein. Diodes Incorporated does not assume any liability arising out of the application or use of this document or any product described herein; neither does Diodes Incorporated convey any license under its patent or trademark rights, nor the rights of others. Any Customer or user of this document or products described herein in such applications shall assume all risks of such use and will agree to hold Diodes Incorporated and all the companies whose products are represented on Diodes Incorporated website, harmless against all damages.

Diodes Incorporated does not warrant or accept any liability whatsoever in respect of any products purchased through unauthorized sales channel.

Should Customers purchase or use Diodes Incorporated products for any unintended or unauthorized application, Customers shall indemnify and hold Diodes Incorporated and its representatives harmless against all claims, damages, expenses, and attorney fees arising out of, directly or indirectly, any claim of personal injury or death associated with such unintended or unauthorized application.

Products described herein may be covered by one or more United States, international or foreign patents pending. Product names and markings noted herein may also be covered by one or more United States, international or foreign trademarks.

LIFE SUPPORT

Diodes Incorporated products are specifically not authorized for use as critical components in life support devices or systems without the express written approval of the Chief Executive Officer of Diodes Incorporated. As used herein:

- A. Life support devices or systems are devices or systems which:
 - 1. are intended to implant into the body, or
 - 2. support or sustain life and whose failure to perform when properly used in accordance with instructions for use provided in the labeling can be reasonably expected to result in significant injury to the user.
- B. A critical component is any component in a life support device or system whose failure to perform can be reasonably expected to cause the failure of the life support device or to affect its safety or effectiveness.

Customers represent that they have all necessary expertise in the safety and regulatory ramifications of their life support devices or systems, and acknowledge and agree that they are solely responsible for all legal, regulatory and safety-related requirements concerning their products and any use of Diodes Incorporated products in such safety-critical, life support devices or systems, notwithstanding any devices- or systems-related information or support that may be provided by Diodes Incorporated. Further, Customers must fully indemnify Diodes Incorporated and its representatives against any damages arising out of the use of Diodes Incorporated products in such safety-critical, life support devices or systems.

Copyright © 2009, Diodes Incorporated

www.diodes.com