

FEATURES

- SHIELDED POWER INDUCTOR
- MOLDED METAL COMPOSITE CONSTRUCTION
- HIGH SATURATION CURRENT CHARACTERISTICS (~ 110A)
- HIGH EFFICIENCY (2X IMPROVEMENT OVER FERRITE CORE INDUCTORS)
- LOW PROFILE (1.8mm ~ 5.2mm)

RoHS Compliant
includes all homogeneous materials

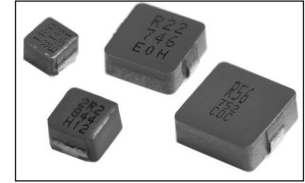

*See Part Number System for Details

CHARACTERISTICS

Case Code	42	53	72	73	74	103	143	145
Inductance Range (μF)	0.1 ~ 2.2	0.68 ~ 3.3	0.1 ~ 4.7	0.1 ~ 4.7	0.1 ~ 10	0.22 ~ 10	0.56 ~ 2.2	0.36~3.3
Ambient Operating Temperature Range	-55°C ~ +85°C							
Maximum Component Temperature (Ambient + Self-Heating)	+125°C							
Temperature Rise at Irms	+40°C							
Inductance Change at Isat	-20% (-30% for some values)							
Inductance Tolerance	±20%							
Resistance to Solder Heat	260°C ±5°C for 10 seconds							

DIMENSIONS (mm)

Series	A	B	C	D ₁	D ₂	E ₁	E ₂	t	F	G	H
NPIM42C	4.15 ± 0.35	4.0 ± 0.3	1.8 ± 0.2	0.8 ± 0.3	1.0 ± 0.1	1.5 ± 0.3	2.2 ± 0.2	0 ~ +0.15	2.2	5.2	2.5
NPIM53C	4.85 ± 0.35	4.7 ± 0.2	2.8 ± 0.2	1.0 ± 0.3	1.5 ± 0.1	1.5 ± 0.3	2.2 ± 0.2	0 ~ +0.15	3.0	7.0	2.5
NPIM72C	7.05 ± 0.35	6.6 ± 0.2	1.6 ± 0.2	1.6 ± 0.2	2.0 ± 0.1	3.0 ± 0.3	3.6 ± 0.2	0 ~ +0.15	3.7	8.4	3.5
NPIM73C	6.95 ± 0.35	6.6 ± 0.2	2.2 ± 0.2	1.6 ± 0.3	2.0 ± 0.1	3.0 ± 0.3	3.6 ± 0.2	0 ~ +0.15	3.7	8.4	3.5
NPIM74C	6.95 ± 0.35	6.6 ± 0.2	2.8 ± 0.2	1.6 ± 0.3	2.0 ± 0.1	3.0 ± 0.3	3.6 ± 0.2	0 ~ +0.15	3.7	8.4	3.5
NPIM103C	See Individual Case Sizes Tables for These Case Sizes										
NPIM104C											
NPIM143C											
NPIM145C											

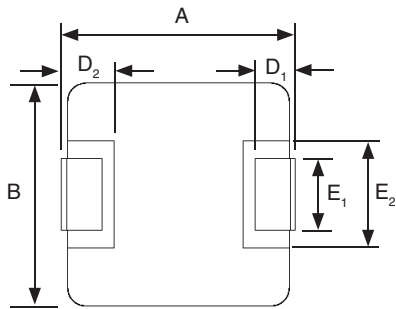

LAND PATTERN

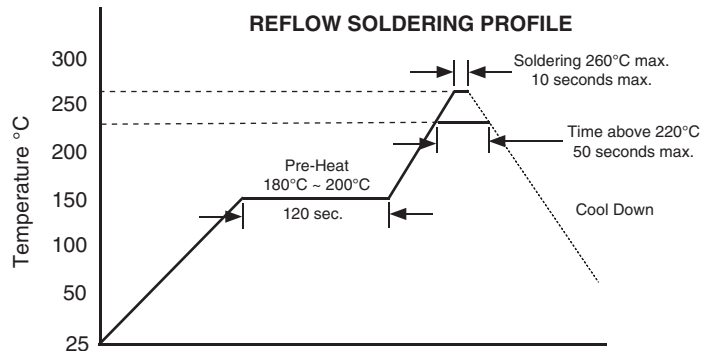
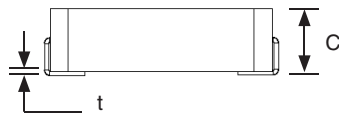
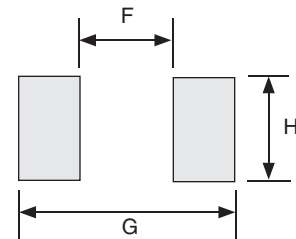

Part Number	STANDARD VALUES - CASE SIZE 42 (4.15 X 4.0 X 1.8mm)				Test Frequency
	Inductance Value (μH)	DC Resistance (mΩ)	DC Current I _{rms} (Amps)	DC Current I _{sat} (Amps)	
NPIM42CR10MTRF	0.1	5.0	11	30	100KHz
NPIM42CR22MTRF	0.22	8.0	9	17	
NPIM42CR47MTRF	0.47	15.5	6	11.5	
NPIM42C1R0MTRF	1.0	36	3.8	8.5	
NPIM42C1R5MTRF	1.5	46	4.0	6.0*	
NPIM42C2R2MTRF	2.2	58	3.0	5.0*	

Maximum +40°C temperature rise at I_{rms}. Typical -20% inductance change at I_{sat} [*-30%]

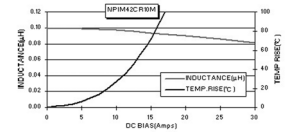

[Link to NPIM42 Performance Curves](#)

Part Number	STANDARD VALUES - CASE SIZE 53 (4.85 X 4.7 X 2.8mm)				Test Frequency
	Inductance Value (μH)	DC Resistance (mΩ)	DC Current I _{rms} (Amps)	DC Current I _{sat} (Amps)	
NPIM53CR68MTRF	0.68	12	8.5	14	100KHz
NPIM53C1R0MTRF	1.0	14	7	11	
NPIM53C1R2MTRF	1.2	16	6.5	11	
NPIM53C1R5MTRF	1.5	20	6.0	10	
NPIM53C2R2MTRF	2.2	35	5.5	9.0	
NPIM53C3R3MTRF	3.3	38	5.0	7.0	

Maximum +40°C temperature rise at I_{rms}. Typical -20% inductance change at I_{sat}.

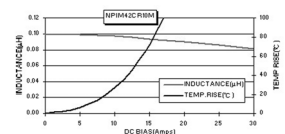

[Link to NPIM53 Performance Curves](#)

Part Number	STANDARD VALUES - CASE SIZE 72 (7.05 X 6.6 X 1.6mm)				Test Frequency
	Inductance Value (μH)	DC Resistance (mΩ)	DC Current I _{rms} (Amps)	DC Current I _{sat} (Amps)	
NPIM72CR10MTRF	0.1	2.5	18	45	100KHz
NPIM72CR33MTRF	0.33	6.8	12	22	
NPIM72CR47MTRF	0.47	8.4	11	18	
NPIM72CR68MTRF	0.68	12.7	9.0	17	
NPIM72C1R0MTRF	1.0	17	7.0	14	
NPIM72C2R0MTRF	2.0	32	6.0	13	
NPIM72C2R2MTRF	2.2	35	6.0	13	
NPIM72C4R7MTRF	4.7	70	3.5	5.0	

Maximum +40°C temperature rise at I_{rms}. Typical -30% inductance change at I_{sat}.

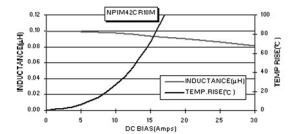

[Link to NPIM72 Performance Curves](#)

PART NUMBER SYSTEM

NPIM -- C 5R6 M TR E

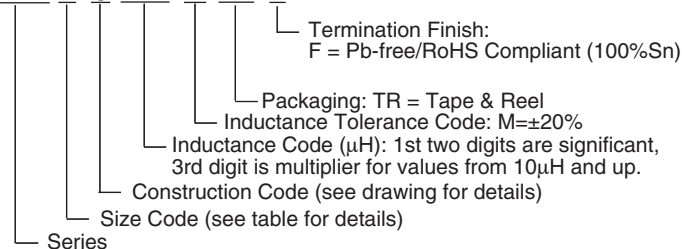

Part Number	STANDARD VALUES - CASE SIZE 73 (6.95 X 6.6 X 2.2mm)				Test Frequency
	Inductance Value (μH)	DC Resistance (mΩ)	DC Current I _{rms} (Amps)	DC Current I _{sat} (Amps)	
NPIM73CR10MTRF	0.1	1.7	30	70	100KHz
NPIM73CR20MTRF	0.20	2.8	25	50	
NPIM73CR47MTRF	0.47	5.5	15	22	
NPIM73C1R0MTRF	1.0	13.5	9.0	16	
NPIM73C2R2MTRF	2.2	28	7.0	14	
NPIM73C3R3MTRF	3.3	39	5.5	13	
NPIM73C4R7MTRF	4.7	50	5.0	10	

Maximum +40°C temperature rise at I_{rms}. Typical -30% inductance change at I_{sat}.

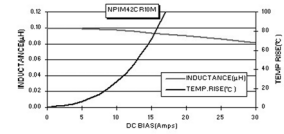

[Link to NPIM73 Performance Curves](#)

Part Number	STANDARD VALUES - CASE SIZE 74 (6.95 X 6.6 X 2.8mm)				Test Frequency
	Inductance Value (μH)	DC Resistance (mΩ)	DC Current I _{rms} (Amps)	DC Current I _{sat} (Amps)	
NPIM74CR10MTRF	0.1	1.7	32.5	60	100KHz
NPIM74CR20MTRF	0.2	3.0	24	41	
NPIM74CR22MTRF	0.22	2.8	23	40	
NPIM74CR33MTRF	0.33	3.9	20	30	
NPIM74CR47MTRF	0.47	4.2	17.5	26	
NPIM74CR68MTRF	0.68	5.5	15.5	25	
NPIM74CR82MTRF	0.82	8.0	13	24	
NPIM74C1R0MTRF	1.0	10	11	22	
NPIM74C1R2MTRF	1.2	12	10	20	
NPIM74C1R5MTRF	1.5	15	9.0	18	
NPIM74C2R2MTRF	2.2	20	8.0	14	
NPIM74C3R3MTRF	3.3	30	6.0	13.5	
NPIM74C4R7MTRF	4.7	40	5.5	10	
NPIM74C6R8MTRF	6.8	60	4.5	8.0	
NPIM74C8R2MTRF	8.2	60	4.5	6.0*	
NPIM74C100MTRF	10	68	4.0	5.5*	

Maximum +40°C temperature rise at I_{rms}. Typical -20% inductance change at I_{sat} [*-30%]

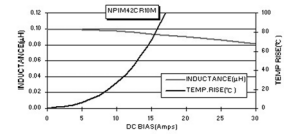

[Link to NPIM74 Performance Curves](#)

Part Number	STANDARD VALUES - CASE SIZE 103				Test Frequency
	Inductance Value (μH)	DC Resistance (mΩ)	DC Current I _{rms} (Amps)	DC Current I _{sat} (Amps)	
NPIM103CR36MTRF	0.36	1.6	23	28	100KHz
NPIM103CR47MTRF	0.47	2.5	20	26	
NPIM103C1R0MTRF	1.0	3.0	20	27	
NPIM103C8R2MTRF	8.2	45	5.0	8.5	

Maximum +40°C temperature rise at I_{rms}. Typical -30% inductance change at I_{sat}.

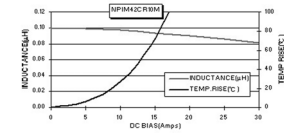

[Link to NPIM103 Performance Curves](#)

NPIM103S CASE AND LAND PATTERN DIMENSIONS

Series	Value	A	B	C	D ₁	D ₂	E ₁	E ₂	t	F	G	H
NPIM103C	R36, R47	11.15 ± 0.35	10.0 ± 0.3	2.8 ± 0.2	2.0 ± 0.5	2.5 ± 0.1	3.0 ± 0.5	5.0 ± 0.2	0 ~ +0.15	5.4	13.6	4.1
	1R0	11.15 ± 0.35	10.0 ± 0.3	3.3 ± 0.2	2.0 ± 0.5	2.5 ± 0.1	3.0 ± 0.5	5.0 ± 0.2	0 ~ +0.15	5.4	13.6	4.1
	8R2	10.85 ± 0.35	10.0 ± 0.3	2.8 ± 0.2	2.0 ± 0.5	2.5 ± 0.1	3.0 ± 0.5	5.0 ± 0.2	0 ~ +0.15	5.4	13.6	4.1

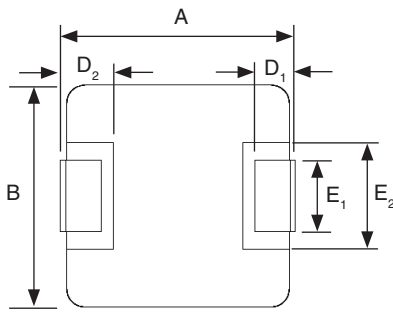

LAND PATTERN

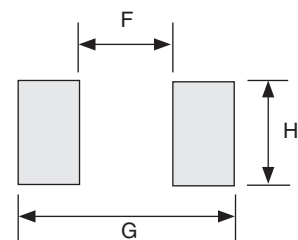

Part Number	STANDARD VALUES - CASE SIZE 104				Test Frequency
	Inductance Value (μH)	DC Resistance ($\text{m}\Omega$)	DC Current I_{rms} (Amps)	DC Current I_{sat} (Amps)	
NPIM104CR22MTRF	0.22	1.0	35	60	100KHz
NPIM104CR36MTRF	0.36	1.2	30	50*	
NPIM104CR56MTRF	0.56	1.8	25	33*	
NPIM104CR68MTRF	0.68	2.7	22	39	
NPIM104CR88MTRF	0.88	3.0	20	38	
NPIM104C1R0MTRF	1.0	3.3	18	28*	
NPIM104C1R5MTRF	1.5	4.2	16	33	
NPIM104C2R2MTRF	2.2	7.0	12	27	
NPIM104C3R3MTRF	3.3	11.8	10	16*	
NPIM104C4R7MTRF	4.7	15	10	13*	
NPIM104C6R8MTRF	6.8	24	7.5	9.5*	
NPIM104C100MTRF	10	30	6.0	6.0*	

Maximum +40°C temperature rise at I_{rms} . Typical -20% inductance change at I_{sat} [*-30%]

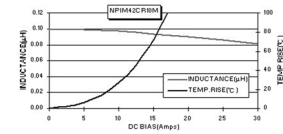

[Link to NPIM104 Performance Curves](#)

NPIM104S CASE AND LAND PATTERN DIMENSIONS

Series	Value	A	B	C	D ₁	D ₂	E ₁	E ₂	t	F	G	H
NPIM104C	R22, R36, R56, R68, R88, R10, 1R5	11.15 ± 0.35	10.0 ± 0.3	3.8 ± 0.2	2.0 ± 0.5	2.5 ± 0.1	3.0 ± 0.5	5.0 ± 0.2	0 ~ +0.15	5.4	13.6	4.1
	2R2, 3R3, 100	10.85 ± 0.35	10.0 ± 0.3	3.8 ± 0.2	2.0 ± 0.5	2.5 ± 0.1	3.0 ± 0.5	5.0 ± 0.2	0 ~ +0.15	5.4	13.6	4.1
	4R7, 6R8	10.85 ± 0.35	10.0 ± 0.3	4.3 ± 0.2	2.0 ± 0.5	2.5 ± 0.1	3.0 ± 0.5	5.0 ± 0.2	0 ~ +0.15	5.4	13.6	4.1

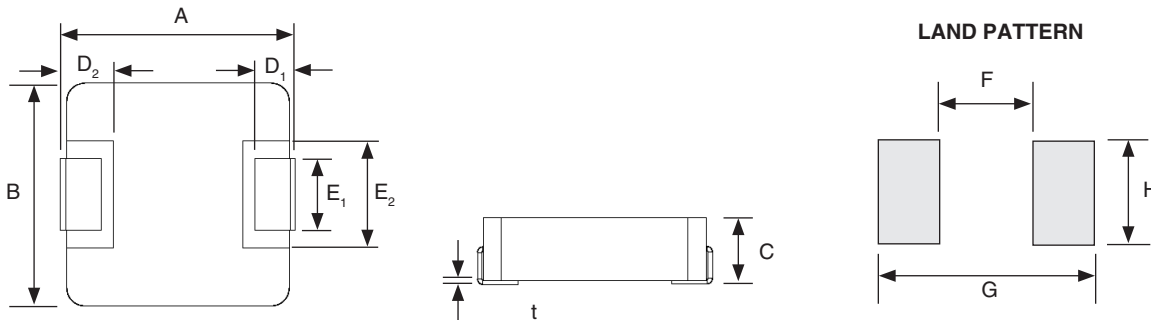

Part Number	STANDARD VALUES - CASE SIZE 143				Test Frequency
	Inductance Value (μH)	DC Resistance (mΩ)	DC Current I _{rms} (Amps)	DC Current I _{sat} (Amps)	
NPIM143CR56MTRF	0.56	2.20	29	51	100KHz
NPIM143CR68MTRF	0.68	2.50	28	49	
NPIM143C1R0MTRF	1.0	3.50	24	40	
NPIM143C2R2MTRF	2.2	8.00	16	29	

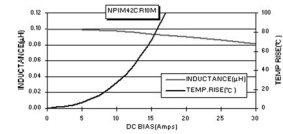

[Link to NPIM143 Performance Curves](#)

Maximum +40°C temperature rise at I_{rms}. Typical -20% inductance change at I_{sat}.

NPIM143S CASE AND LAND PATTERN DIMENSIONS

Series	Value	A	B	C	D ₁	D ₂	E ₁	E ₂	t	F	G	H
NPIM143C	R56 ~ R68	13.45 ± 0.35	12.6 ± 0.2	3.3 ± 0.2	2.0 ± 0.5	2.5 ± 0.1	4.0 ± 0.5	6.0 ± 0.2	0 ~ +0.15	8.0	14.5	5.0
	1R0 ~ 2R2	13.45 ± 0.35	12.6 ± 0.2	3.3 ± 0.2	2.0 ± 0.5	2.5 ± 0.1	3.0 ± 0.5	6.0 ± 0.2	0 ~ +0.15	8.0	14.5	5.0

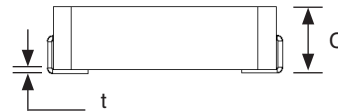
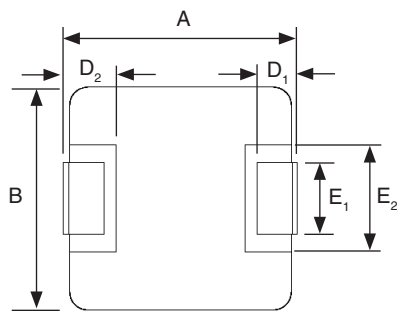

LAND PATTERN

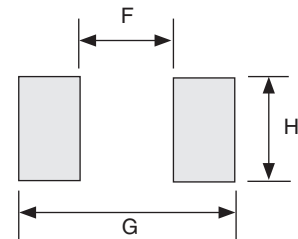

Part Number	STANDARD VALUES - CASE SIZE 145				Test Frequency
	Inductance Value (μH)	DC Resistance max. (mΩ)	DC Current I _{rms} (Amps)	DC Current I _{sat} (Amps)	
NPIM145CR36MTRF	0.36	1.10	41	75	100KHz
NPIM145CR47MTRF	0.47	1.30	38	65	
NPIM145CR50MTRF	0.50	1.50	36	55	
NPIM145CR56MTRF	0.56	1.50	36	55	
NPIM145CR62MTRF	0.62	1.70	34	54	
NPIM145CR68MTRF	0.68	1.70	34	54	
NPIM145C1R0MTRF	1.0	2.50	29	50	
NPIM145C1R5MTRF	1.5	4.10	23	48	
NPIM145C2R2MTRF	2.2	5.50	20	32	
NPIM145C3R3MTRF	3.3	9.20	15	32	
NPIM145C4R7MTRF	4.7	15.0	12	27	
NPIM145C6R8MTRF	6.8	18.5	11	21	

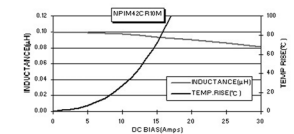

[Link to NPIM145 Performance Curves](#)

Maximum +40°C temperature rise at I_{rms}. Typical -20% inductance change at I_{sat}.

NPIM145C CASE AND LAND PATTERN DIMENSIONS

Series	Value	A	B	C	D ₁	D ₂	E ₁	E ₂	t	F	G	H
NPIM145C	R36	13.65 ± 0.35	12.6 ± 0.2	5.0 ± 0.2	2.0 ± 0.5	2.5 ± 0.1	4.0 ± 0.5	6.0 ± 0.2	0 ~ +0.15	8.0	14.5	5.0
	R47, R50, R56, R62, R68, 1R0, 1R5	13.45 ± 0.35	12.6 ± 0.2	4.8 ± 0.2	2.0 ± 0.5	2.5 ± 0.1	4.0 ± 0.5	6.0 ± 0.2	0 ~ +0.15	8.0	14.5	5.0
	2R2, 3R3, 4R7, 6R8	13.45 ± 0.35	12.6 ± 0.2	4.8 ± 0.2	2.0 ± 0.5	2.5 ± 0.1	3.0 ± 0.5	6.0 ± 0.2	0 ~ +0.15	8.0	14.5	5.0

CARRIER TAPE DIMENSIONS (mm)

Series	Part Thickness	Ao	Bo	Co	Po	Ko	t	W
NPIM42C	All	4.2 ± 0.10	4.5 ± 0.10	5.5 ± 0.10	8.0 ± 0.10	2.5 ± 0.15	1.55 ± 0.05	12.0 ± 0.30
NPIM53C	All	5.4 ± 0.10	5.2 ± 0.10	7.5 ± 0.10	12.0 ± 0.10	3.6 ± 0.15	0.35 ± 0.05	16.0 ± 0.30
NPIM72C	All	7.2 ± 0.10	7.5 ± 0.10	7.5 ± 0.10	12.0 ± 0.10	2.3 ± 0.10	0.30 ± 0.10	16.0 ± 0.30
NPIM73C	All	7.2 ± 0.10	7.5 ± 0.10	7.5 ± 0.10	12.0 ± 0.10	3.6 ± 0.15	0.30 ± 0.10	16.0 ± 0.30
NPIM74C	All	7.2 ± 0.10	7.5 ± 0.10	7.5 ± 0.10	12.0 ± 0.10	3.6 ± 0.15	0.30 ± 0.10	16.0 ± 0.30
NPIM103C	All	10.7 ± 0.10	12.0 ± 0.10	11.5 ± 0.10	16.0 ± 0.10	4.0 ± 0.10	0.35 ± 0.05	24.0 ± 0.30
NPIM104C	3.8mm	10.7 ± 0.10	12.0 ± 0.10	11.5 ± 0.10	16.0 ± 0.10	4.0 ± 0.10	0.35 ± 0.05	24.0 ± 0.30
	4.3mm					4.5 ± 0.10		
NPIM143C	All	13.4 ± 0.10	14.1 ± 0.10	11.5 ± 0.10	16.0 ± 0.1	3.7 ± 0.15	0.35 ± 0.05	24.0 ± 0.30
NPIM145C	All	13.4 ± 0.10	14.1 ± 0.10	11.5 ± 0.10	16.0 ± 0.1	5.1 ± 0.10	0.35 ± 0.05	24.0 ± 0.30

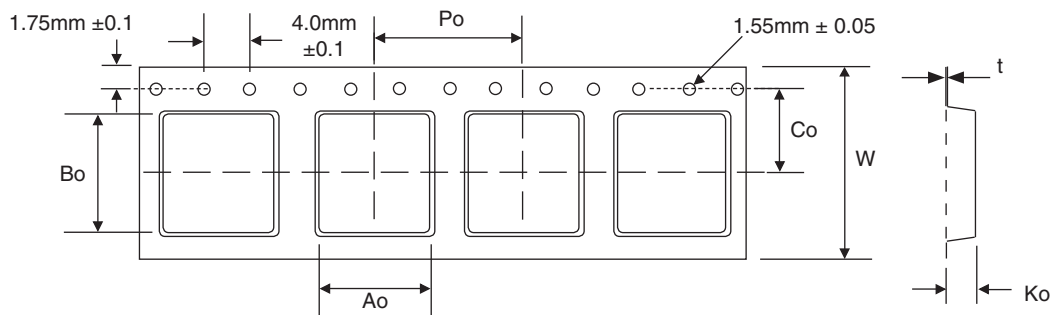

REEL DIMENSIONS (mm)

Series	A	B
NPIM42C	12.5 ± 0.5	2.0 ± 0.2
NPIM53C	16.0 ± 0.5	2.0 ± 0.2
NPIM72C	16.0 ± 0.5	2.0 ± 0.2
NPIM73C	16.0 ± 0.5	2.0 ± 0.2
NPIM74C	16.0 ± 0.5	2.0 ± 0.2
NPIM103C	24.5 ± 0.5	2.0 ± 0.2
NPIM104C	24.5 ± 0.5	2.0 ± 0.2
NPIM143C	24.5 ± 0.5	2.0 ± 0.2
NPIM145C	24.5 ± 0.5	2.0 ± 0.2

