

# FX6ASJ-03

High-Speed Switching Use  
Pch Power MOS FET

REJ03G0247-0200

Rev.2.00

Nov 21, 2006

## Features

- Drive voltage : 4 V
- $V_{DSS}$  : - 30 V
- $r_{DS(ON)(max)}$  : 0.29  $\Omega$
- $I_D$  : - 6 A
- Recovery Time of the Integrated Fast Recovery Diode (TYP.) : 40 ns

## Outline

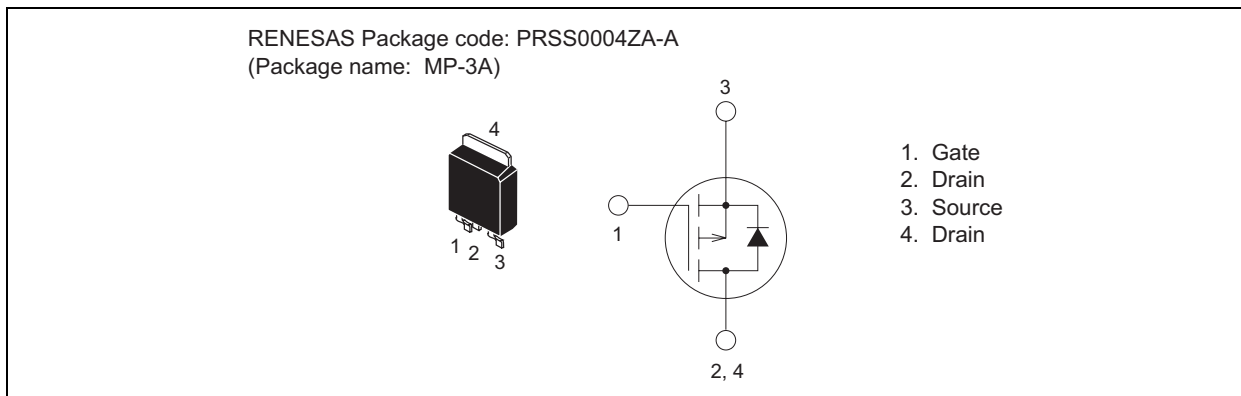

## Applications

Motor control, lamp control, solenoid control, DC-DC converters, etc.

## Maximum Ratings

( $T_c = 25^\circ\text{C}$ )

Parameter	Symbol	Ratings	Unit	Conditions
Drain-source voltage	$V_{DSS}$	-30	V	$V_{GS} = 0\text{ V}$
Gate-source voltage	$V_{GSS}$	$\pm 20$	V	$V_{DS} = 0\text{ V}$
Drain current	$I_D$	-6	A	
Drain current (Pulsed)	$I_{DM}$	-24	A	
Avalanche current (Pulsed)	$I_{DA}$	-6	A	$L = 30\ \mu\text{H}$
Source current	$I_S$	-6	A	
Source current (Pulsed)	$I_{SM}$	-24	A	
Maximum power dissipation	$P_D$	20	W	
Channel temperature	$T_{ch}$	- 55 to +150	$^\circ\text{C}$	
Storage temperature	$T_{stg}$	- 55 to +150	$^\circ\text{C}$	
Mass	—	0.32	g	Typical value

## Electrical Characteristics

(Tch = 25°C)

Parameter	Symbol	Min.	Typ.	Max.	Unit	Test conditions
Drain-source breakdown voltage	$V_{(BR)DSS}$	-30	—	—	V	$I_D = -1 \text{ mA}$ , $V_{GS} = 0 \text{ V}$
Gate-source leakage current	$I_{GSS}$	—	—	$\pm 0.1$	$\mu\text{A}$	$V_{GS} = \pm 20 \text{ V}$ , $V_{DS} = 0 \text{ V}$
Drain-source leakage current	$I_{DSS}$	—	—	-0.1	mA	$V_{DS} = -30 \text{ V}$ , $V_{GS} = 0 \text{ V}$
Gate-source threshold voltage	$V_{GS(th)}$	-1.3	-1.8	-2.3	V	$I_D = -1 \text{ mA}$ , $V_{DS} = -10 \text{ V}$
Drain-source on-state resistance	$r_{DS(ON)}$	—	0.23	0.29	$\Omega$	$I_D = -3 \text{ A}$ , $V_{GS} = -10 \text{ V}$
Drain-source on-state resistance	$r_{DS(ON)}$	—	0.46	0.62	$\Omega$	$I_D = -1 \text{ A}$ , $V_{GS} = -4 \text{ V}$
Drain-source on-state voltage	$V_{DS(ON)}$	—	-0.69	-0.87	V	$I_D = -3 \text{ A}$ , $V_{GS} = -10 \text{ V}$
Forward transfer admittance	$ y_{fs} $	—	2.6	—	S	$I_D = -3 \text{ A}$ , $V_{DS} = -5 \text{ V}$
Input capacitance	$C_{iss}$	—	550	—	pF	$V_{DS} = -10 \text{ V}$ , $V_{GS} = 0 \text{ V}$ , $f = 1 \text{ MHz}$
Output capacitance	$C_{oss}$	—	165	—	pF	
Reverse transfer capacitance	$C_{rss}$	—	45	—	pF	
Turn-on delay time	$t_{d(on)}$	—	9	—	ns	$V_{DD} = -15 \text{ V}$ , $I_D = -3 \text{ A}$ , $V_{GS} = -10 \text{ V}$ , $R_{GEN} = R_{GS} = 50 \Omega$
Rise time	$t_r$	—	14	—	ns	
Turn-off delay time	$t_{d(off)}$	—	32	—	ns	
Fall time	$t_f$	—	14	—	ns	
Source-drain voltage	$V_{SD}$	—	-1.0	-1.5	V	$I_S = -3 \text{ A}$ , $V_{GS} = 0 \text{ V}$
Thermal resistance	$R_{th(ch-c)}$	—	—	6.25	$^{\circ}\text{C/W}$	Channel to case
Reverse recovery time	$t_{rr}$	—	40	—	ns	$I_S = -3 \text{ A}$ , $dis/dt = 50 \text{ A}/\mu\text{s}$

Performance Curves

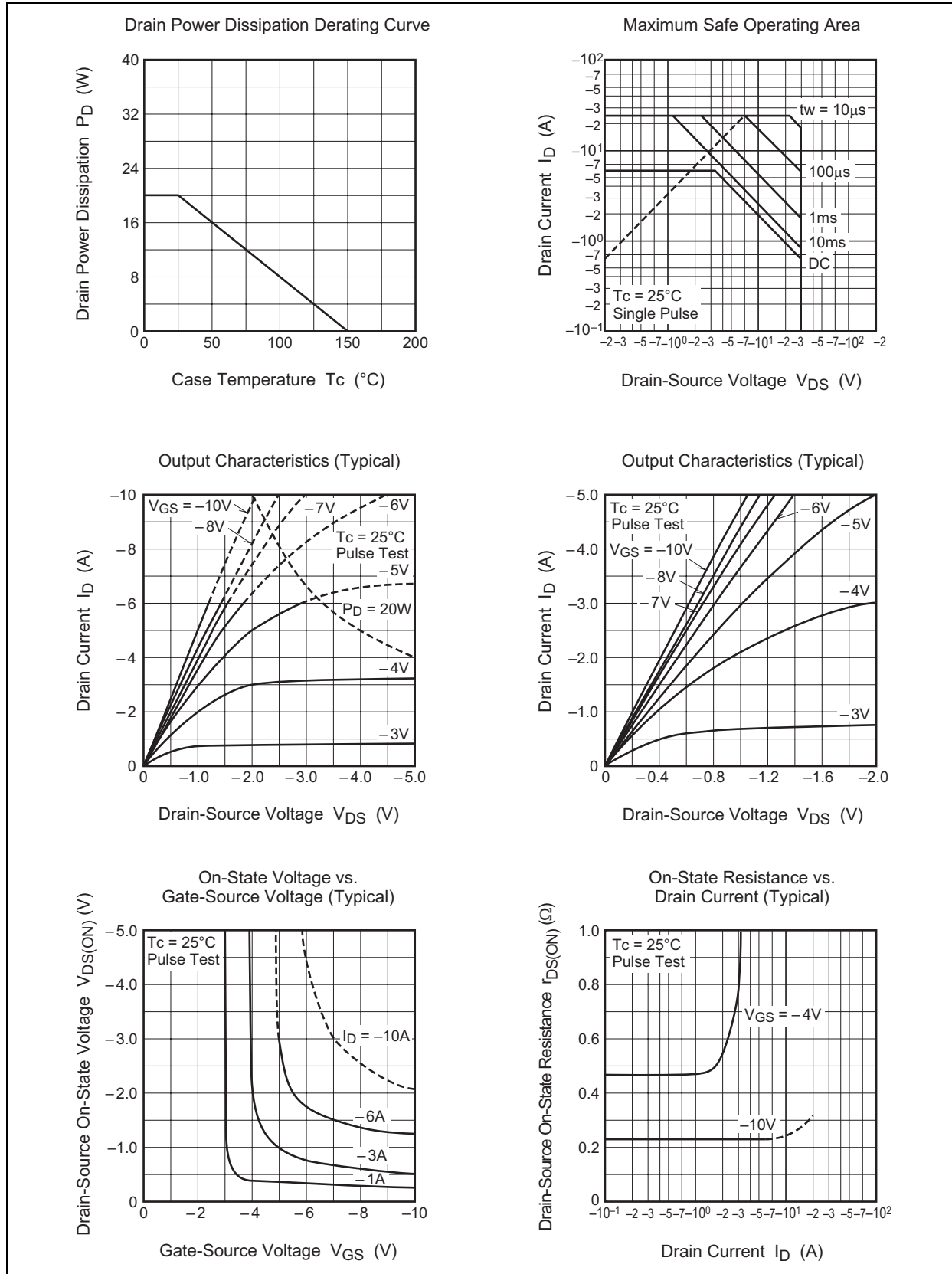

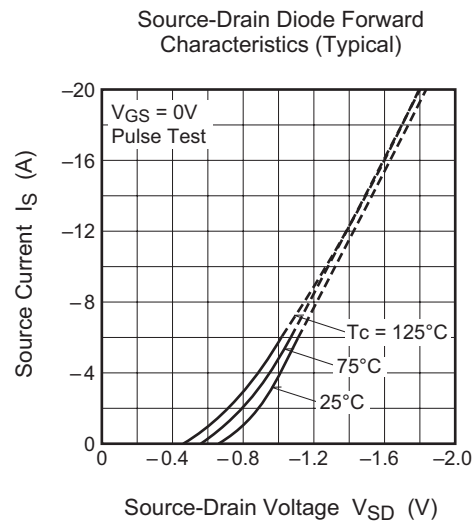
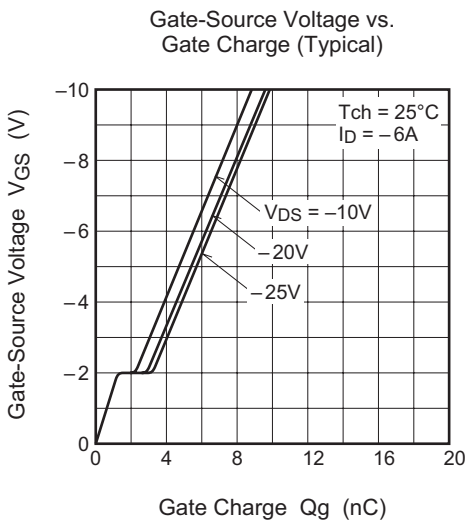
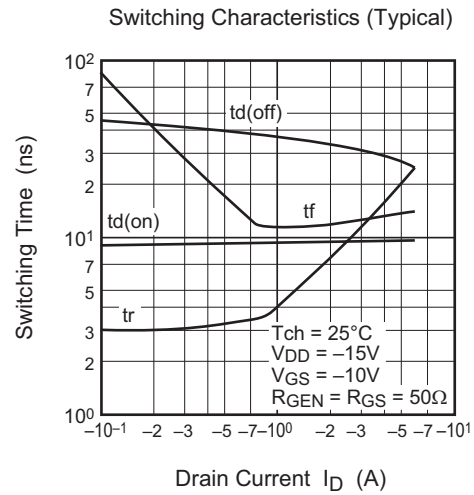
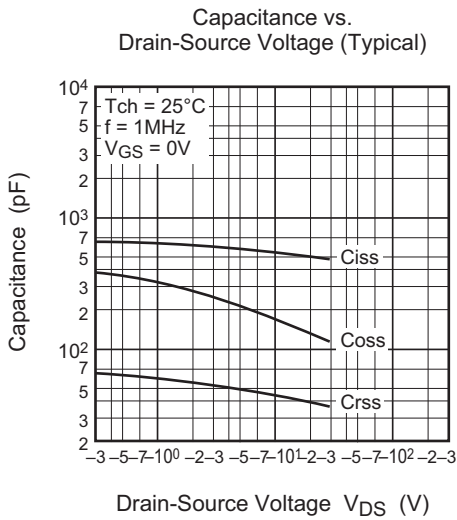
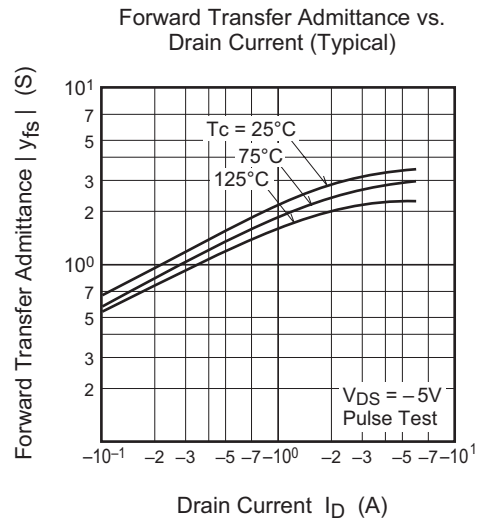
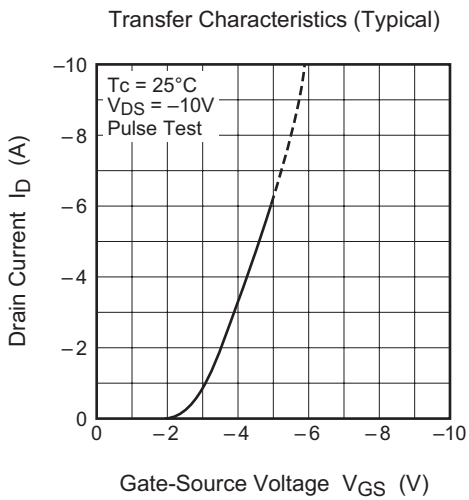

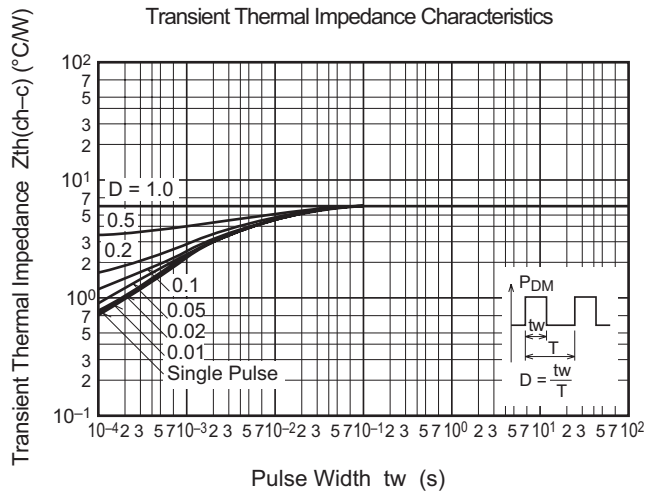
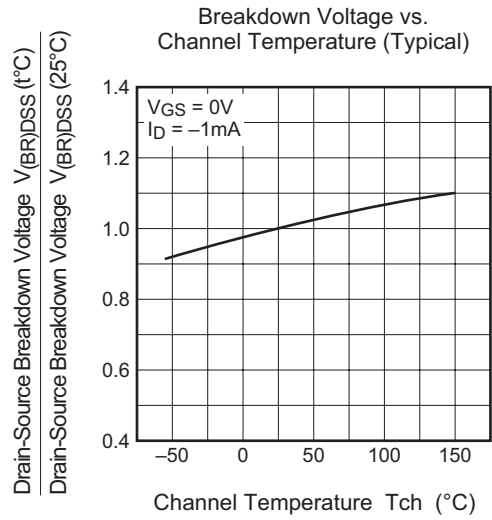
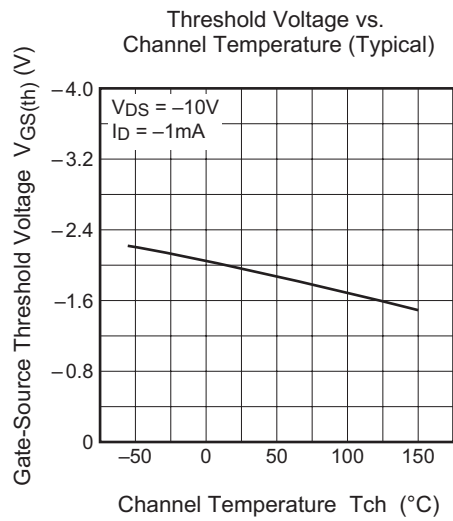
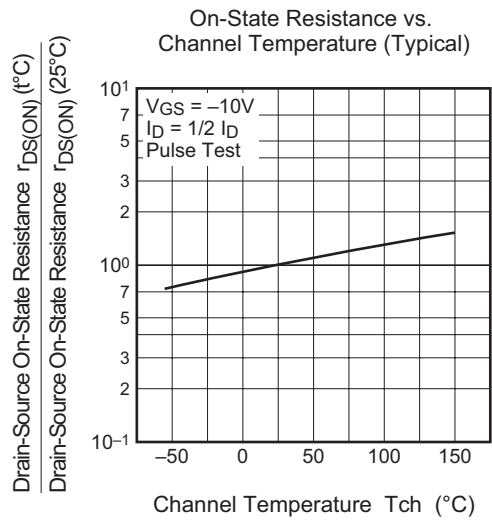

Switching Time Measurement Circuit

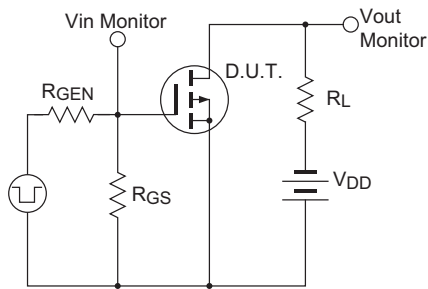

Switching Waveform

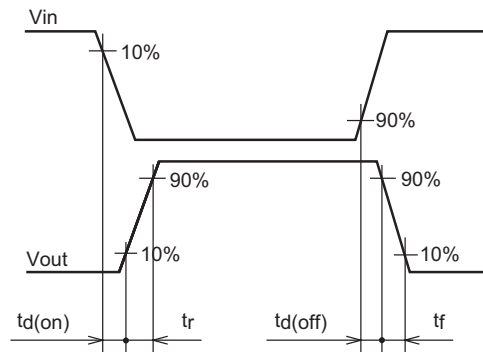

### Package Dimensions

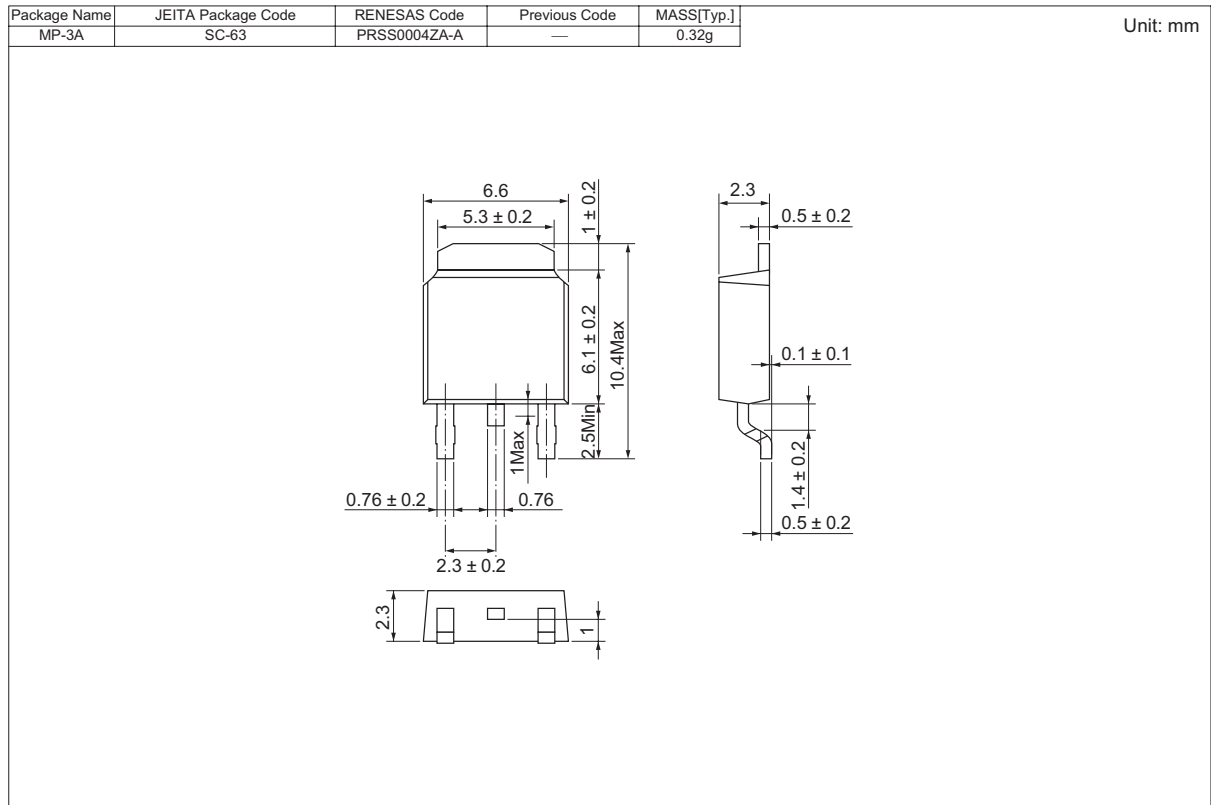

### Order Code

Lead form	Standard packing	Quantity	Standard order code	Standard order code example
Surface-mounted type	Taping	3000	Type name – T +Direction (1 or 2) +3	FX6ASJ-03-T13
Surface-mounted type	Plastic Magazine (Tube)	75	Type name	FX6ASJ-03

Note : Please confirm the specification about the shipping in detail.

Notes:

1. This document is provided for reference purposes only so that Renesas customers may select the appropriate Renesas products for their use. Renesas neither makes warranties or representations with respect to the accuracy or completeness of the information contained in this document nor grants any license to any intellectual property rights or any other rights of Renesas or any third party with respect to the information in this document.
2. Renesas shall have no liability for damages or infringement of any intellectual property or other rights arising out of the use of any information in this document, including, but not limited to, product data, diagrams, charts, programs, algorithms, and application circuit examples.
3. You should not use the products or the technology described in this document for the purpose of military applications such as the development of weapons of mass destruction or for the purpose of any other military use. When exporting the products or technology described herein, you should follow the applicable export control laws and regulations, and procedures required by such laws and regulations.
4. All information included in this document such as product data, diagrams, charts, programs, algorithms, and application circuit examples, is current as of the date this document is issued. Such information, however, is subject to change without any prior notice. Before purchasing or using any Renesas products listed in this document, please confirm the latest product information with a Renesas sales office. Also, please pay regular and careful attention to additional and different information to be disclosed by Renesas such as that disclosed through our website. (<http://www.renesas.com>)
5. Renesas has used reasonable care in compiling the information included in this document, but Renesas assumes no liability whatsoever for any damages incurred as a result of errors or omissions in the information included in this document.
6. When using or otherwise relying on the information in this document, you should evaluate the information in light of the total system before deciding about the applicability of such information to the intended application. Renesas makes no representations, warranties or guarantees regarding the suitability of its products for any particular application and specifically disclaims any liability arising out of the application and use of the information in this document or Renesas products.
7. With the exception of products specified by Renesas as suitable for automobile applications, Renesas products are not designed, manufactured or tested for applications or otherwise in systems the failure or malfunction of which may cause a direct threat to human life or create a risk of human injury or which require especially high quality and reliability such as safety systems, or equipment or systems for transportation and traffic, healthcare, combustion control, aerospace and aeronautics, nuclear power, or undersea communication transmission. If you are considering the use of our products for such purposes, please contact a Renesas sales office beforehand. Renesas shall have no liability for damages arising out of the uses set forth above.
8. Notwithstanding the preceding paragraph, you should not use Renesas products for the purposes listed below:
  - (1) artificial life support devices or systems
  - (2) surgical implantations
  - (3) healthcare intervention (e.g., excision, administration of medication, etc.)
  - (4) any other purposes that pose a direct threat to human lifeRenesas shall have no liability for damages arising out of the uses set forth in the above and purchasers who elect to use Renesas products in any of the foregoing applications shall indemnify and hold harmless Renesas Technology Corp., its affiliated companies and their officers, directors, and employees against any and all damages arising out of such applications.
9. You should use the products described herein within the range specified by Renesas, especially with respect to the maximum rating, operating supply voltage range, movement power voltage range, heat radiation characteristics, installation and other product characteristics. Renesas shall have no liability for malfunctions or damages arising out of the use of Renesas products beyond such specified ranges.
10. Although Renesas endeavors to improve the quality and reliability of its products, IC products have specific characteristics such as the occurrence of failure at a certain rate and malfunctions under certain use conditions. Please be sure to implement safety measures to guard against the possibility of physical injury, and injury or damage caused by fire in the event of the failure of a Renesas product, such as safety design for hardware and software including but not limited to redundancy, fire control and malfunction prevention, appropriate treatment for aging degradation or any other applicable measures. Among others, since the evaluation of microcomputer software alone is very difficult, please evaluate the safety of the final products or system manufactured by you.
11. In case Renesas products listed in this document are detached from the products to which the Renesas products are attached or affixed, the risk of accident such as swallowing by infants and small children is very high. You should implement safety measures so that Renesas products may not be easily detached from your products. Renesas shall have no liability for damages arising out of such detachment.
12. This document may not be reproduced or duplicated, in any form, in whole or in part, without prior written approval from Renesas.
13. Please contact a Renesas sales office if you have any questions regarding the information contained in this document, Renesas semiconductor products, or if you have any other inquiries.



**RENESAS SALES OFFICES**

<http://www.renesas.com>

Refer to "<http://www.renesas.com/en/network>" for the latest and detailed information.

**Renesas Technology America, Inc.**

450 Holger Way, San Jose, CA 95134-1368, U.S.A  
Tel: <1> (408) 382-7500, Fax: <1> (408) 382-7501

**Renesas Technology Europe Limited**

Dukes Meadow, Millboard Road, Bourne End, Buckinghamshire, SL8 5FH, U.K.  
Tel: <44> (1628) 585-100, Fax: <44> (1628) 585-900

**Renesas Technology (Shanghai) Co., Ltd.**

Unit 204, 205, AZIACenter, No.1233 Lujiazui Ring Rd, Pudong District, Shanghai, China 200120  
Tel: <86> (21) 5877-1818, Fax: <86> (21) 6887-7898

**Renesas Technology Hong Kong Ltd.**

7th Floor, North Tower, World Finance Centre, Harbour City, 1 Canton Road, Tsimshatsui, Kowloon, Hong Kong  
Tel: <852> 2265-6688, Fax: <852> 2730-6071

**Renesas Technology Taiwan Co., Ltd.**

10th Floor, No.99, Fushing North Road, Taipei, Taiwan  
Tel: <886> (2) 2715-2888, Fax: <886> (2) 2713-2999

**Renesas Technology Singapore Pte. Ltd.**

1 Harbour Front Avenue, #06-10, Keppel Bay Tower, Singapore 098632  
Tel: <65> 6213-0200, Fax: <65> 6278-8001

**Renesas Technology Korea Co., Ltd.**

Kukje Center Bldg, 18th Fl., 191, 2-ka, Hangang-ro, Yongsan-ku, Seoul 140-702, Korea  
Tel: <82> (2) 796-3115, Fax: <82> (2) 796-2145

**Renesas Technology Malaysia Sdn. Bhd**

Unit 906, Block B, Menara Amcorp, Amcorp Trade Centre, No.18, Jalan Persiaran Barat, 46050 Petaling Jaya, Selangor Darul Ehsan, Malaysia  
Tel: <603> 7955-9390, Fax: <603> 7955-9510