

AVALANCHE ALTERNATOR RECTIFIER AS4024 AND AS4028

PASSIVATED ANISOTROPIC RECTIFIER TECHNOLOGY

Mean Breakdown Voltage - 24 and 28 volts Peak Pulse Current - 80 Amperes

PATENTED*

CASE STYLE ASC

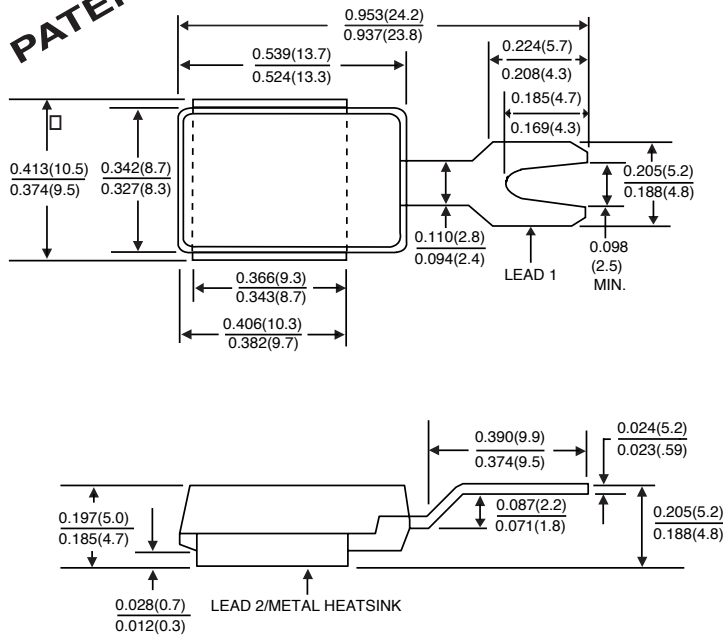

Dimensions in inches and (millimeters)

* Patent #s 4,980,315
5,166,769
5,278,094

For positive polarity use "P" suffix, for negative polarity use "N" suffix
(Polarity refers to lead #1)

FEATURES

- ◆ Plastic package has Underwriters Laboratory Flammability Classification 94V-0
- ◆ High temperature stability due to unique oxide passivation
- ◆ Patented Passivated Anisotropic Rectifier (PAR) construction
- ◆ Integrally molded heatsink provides a very low thermal resistance for maximum heat dissipation
- ◆ Low leakage current at $T_J=175^\circ\text{C}$
- ◆ Low forward voltage drop
- ◆ Ideally suited for alternator rectification and load dump protection
- ◆ High temperature soldering guaranteed: 260°C for 10 seconds at terminals



MECHANICAL DATA

Case: Molded plastic body, surface mount with heatsink integrally mounted in the encapsulation

Terminals: Plated, solderable per MIL-STD-750, Method 2026

Polarity: Unidirectional as marked

Mounting Position: Any

Weight: 0.095 ounces, 2.68 grams

MAXIMUM RATINGS AND ELECTRICAL CHARACTERISTICS

Ratings at 25°C ambient temperature unless otherwise specified.

	SYMBOLS	AS4024	AS4028	UNITS
Maximum working peak standoff voltage	V_{WM}	18.0	20.0	Volts
Minimum reverse breakdown voltage at 100mA	$V_{(BR)}$	20.0	24.0	Volts
Maximum reverse breakdown voltage at 100mA	$V_{(BR)}$	28.0	32.0	Volts
Maximum clamping voltage for 10 μs /10ms exponentially decaying waveform at $I_{PP}=80\text{A}$	V_C	38.0	40.0	Volts
Maximum average rectified forward current at $T_C=150^\circ\text{C}$	$I_{(AV)}$	40.0		Amps
Peak forward surge current, 8.3ms single half sine-wave	I_{FSM}	700.0		Amps
Maximum instantaneous forward voltage at 100A (NOTE 1)	V_F	0.99		Volts
Non- repetitive peak reverse surge current for 10 μs /10ms exponentially decaying waveform	I_{RSM}	75.0		Amps
Maximum reverse leakage current at rated V_{WM} $T_J=25^\circ\text{C}$ $T_J=175^\circ\text{C}$	I_R	1.0	50.0	μA
Maximum thermal resistance junction to case (NOTE 2)	$R_{\theta JC}$	0.9		$^\circ\text{C/W}$
Operating junction and storage temperature range	T_J, T_{STG}	-55 to +200		$^\circ\text{C}$

NOTE:

- (1) Measured on a 300 μs square pulse width
- (2) Mounted on alternator heat sink

NOTICE: Advanced product information is subject to change without notice.

RATING AND CHARACTERISTIC CURVES AVALANCHE ALTERNATOR RECTIFIER - AS4024 AND AS4028

FIG. 1 - FORWARD CURRENT DERATING CURVE

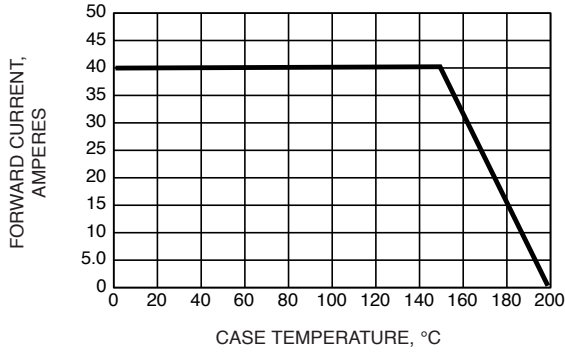

FIG. 2 - TYPICAL INSTANTANEOUS FORWARD CHARACTERISTICS

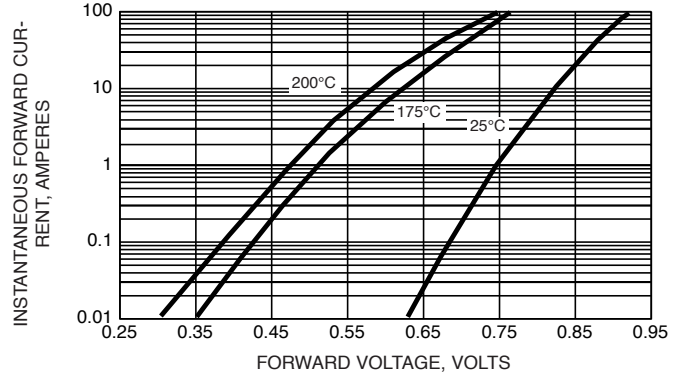

FIG. 3 - PULSE WAVEFORM

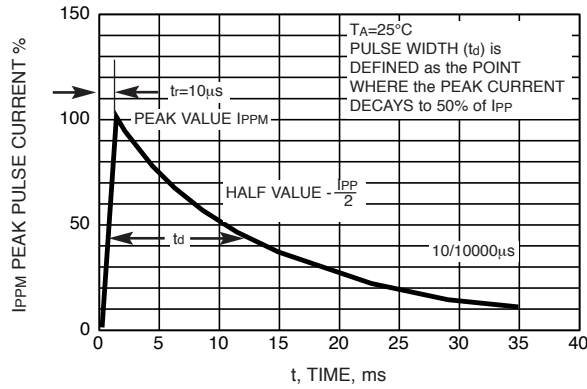

FIG. 4 - REVERSE POWER CAPABILITY

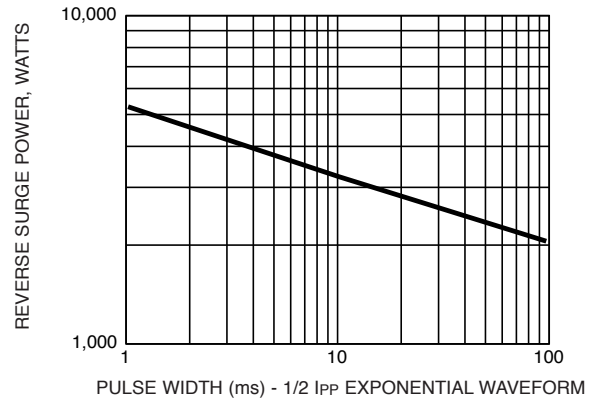

FIG. 5 - LOAD DUMP POWER CHARACTERISTICS (10ms EXPONENTIAL WAVEFORM)

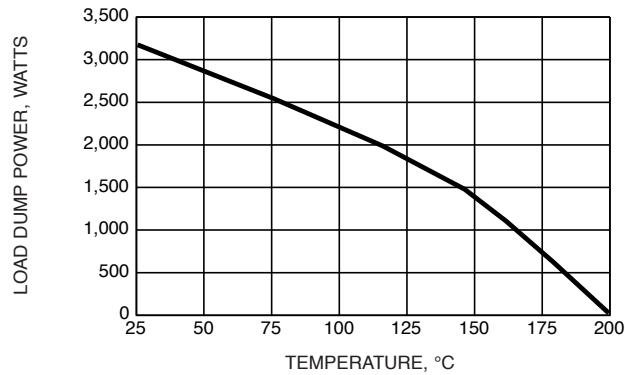

FIG. 6 - TYPICAL REVERSE CHARACTERISTICS

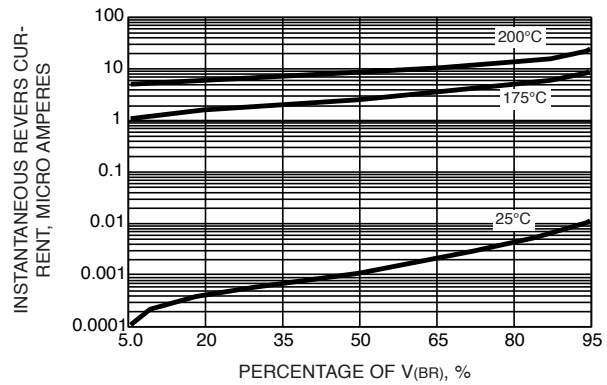

FIG. 7 - TYPICAL TRANSIENT THERMAL IMPEDANCE

