

Optocoupler, Phototransistor Output, Dual Channel

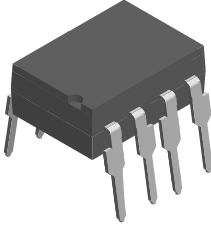

I179045

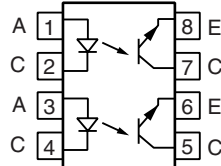

DESCRIPTION

The ILD610 series is a dual channel optocoupler series for high density applications. Each channel consists of an optically coupled pair with a gallium arsenide infrared LED and silicon NPN phototransistor. Signal information, including a DC level, can be transmitted by the device while maintaining a high degree of electrical isolation between input and output. The ILD610 series is the dual version of SFH610 series and uses a repetitive pin-out configuration instead of the more common alternating pin-out used in most dual couplers.

FEATURES

- Dual version of SFH610 series
- Isolation test voltage, 5300 V_{RMS}
- V_{CEsat} 0.25 (≤ 0.4) V at I_F = 10 mA, I_C = 2.5 mA
- V_{CEO} = 70 V
- Lead (Pb)-free component
- Component in accordance to RoHS 2002/95/EC and WEEE 2002/96/EC

RoHS
COMPLIANT

AGENCY APPROVALS

- UL1577, file no. E52744 system code H or J, double protection
- DIN EN 60747-5-2 (VDE 0884)/DIN EN 60747-5-5 pending available with option 1
- CSA 93751
- BSI IEC 60950 IEC 60065

ORDER INFORMATION

PART	REMARKS
ILD610-1	CTR 40 to 80 %, DIP-8
ILD610-2	CTR 63 to 125 %, DIP-8
ILD610-3	CTR 100 to 200 %, DIP-8
ILD610-4	CTR 160 to 320 %, DIP-8
ILD610-2X007	CTR 63 to 125 %, SMD-8 (option 7)
ILD610-3X006	CTR 100 to 200 %, DIP-8 400 mil (option 6)
ILD610-3X009	CTR 100 to 200 %, SMD-8 (option 9)
ILD610-4X009	CTR 160 to 320 %, SMD-8 (option 9)

Note

For additional information on the available options refer to option information.

ABSOLUTE MAXIMUM RATINGS

PARAMETER	TEST CONDITION	SYMBOL	VALUE	UNIT
INPUT				
Reverse voltage		V _R	6.0	V
Surge forward current	t ≤ 1.0 ms	I _{FSM}	1.5	A
Power dissipation		P _{diss}	100	mW
Derate linearly from 25 °C			1.3	mW/°C
Forward continuous current		I _F	60	mA
OUTPUT				
Collector emitter voltage		V _{CE}	70	V
Collector current		I _C	50	mA
	t ≤ 1.0 ms	I _C	100	mA
Power dissipation		P _{diss}	150	mW
Derate linearly from 25 °C			2.0	mW/°C



ABSOLUTE MAXIMUM RATINGS				
PARAMETER	TEST CONDITION	SYMBOL	VALUE	UNIT
COUPLER				
Isolation test voltage	t = 1.0 s	V _{ISO}	5300	V _{RMS}
Isolation resistance	V _{IO} = 500 V, T _{amb} = 25 °C	R _{IO}	≥ 10 ¹²	Ω
	V _{IO} = 500 V, T _{amb} = 100 °C	R _{IO}	≥ 10 ¹¹	Ω
Storage temperature		T _{stg}	- 55 to + 150	°C
Operating temperature		T _{amb}	- 55 to + 100	°C
Junction temperature		T _j	100	°C
Lead soldering time at 260 °C			10	s

Note

T_{amb} = 25 °C, unless otherwise specified.

Stresses in excess of the absolute maximum ratings can cause permanent damage to the device. Functional operation of the device is not implied at these or any other conditions in excess of those given in the operational sections of this document. Exposure to absolute maximum ratings for extended periods of the time can adversely affect reliability.

ELECTRICAL CHARACTERISTICS							
PARAMETER	TEST CONDITION	PART	SYMBOL	MIN.	TYP.	MAX.	UNIT
INPUT							
Forward voltage	I _F = 60 mA		V _F		1.25	1.65	V
Reverse current	V _R = 6.0 V		I _R		0.01	10	μA
Capacitance	V _R = 0 V, f = 1.0 MHz		C _O		25		pF
OUTPUT							
Collector emitter breakdown voltage	I _C = 10 mA, I _E = 10 μA		BV _{CEO}	70	90		V
			BV _{CEO}	6.0	7.0		V
Collector emitter dark current	V _{CE} = 10 V		I _{CEO}		2.0	50	nA
Collector emitter capacitance	V _{CE} = 5.0 V, f = 1.0 MHz		C _{CE}		7.0		pF
Collector emitter leakage current	V _{CE} = 10 V	ILD610-1	I _{CEO}		2.0	50	nA
		ILD610-2	I _{CEO}		2.0	50	nA
		ILD610-3	I _{CEO}		5.0	100	nA
		ILD610-4	I _{CEO}		5.0	100	nA
COUPLER							
Collector emitter saturation voltage	I _F = 10 mA, I _C = 2.5 mA		V _{CEsat}		0.25	0.40	V
Coupling capacitance			C _C		0.35		pF

Note

T_{amb} = 25 °C, unless otherwise specified.

Minimum and maximum values are testing requirements. Typical values are characteristics of the device and are the result of engineering evaluation. Typical values are for information only and are not part of the testing requirements.

CURRENT TRANSFER RATIO								
PARAMETER	TEST CONDITION	PART	SYMBOL	MIN.	TYP.	MAX.	UNIT	
CTR ⁽¹⁾	I _F = 10 mA, V _{CE} = 5.0 V	ILD610-1	CTR	40		80	%	
		ILD610-2	CTR	63		125	%	
		ILD610-3	CTR	100		200	%	
		ILD610-4	CTR	160		320	%	
	I _F = 1.0 mA, V _{CE} = 5.0 V	ILD610-1	CTR		13			%
		ILD610-2	CTR		22			%
		ILD610-3	CTR		34			%
		ILD610-4	CTR		56			%

Note

⁽¹⁾ CTR will match within a ratio of 1.7:1



SWITCHING CHARACTERISTICS							
PARAMETER	TEST CONDITION	PART	SYMBOL	MIN.	TYP.	MAX.	UNIT
NON-SATURATED							
Rise time	$V_{CC} = 5.0\text{ V}, R_L = 75\ \Omega,$ $I_F = 10\text{ mA}$	ILD610-1	t_r		2.0		μs
		ILD610-2			2.5		
		ILD610-3			2.9		
		ILD610-4			3.3		
Fall time	$V_{CC} = 5.0\text{ V}, R_L = 75\ \Omega,$ $I_F = 10\text{ mA}$	ILD610-1	t_f		2.0		μs
		ILD610-2			2.6		
		ILD610-3			3.1		
		ILD610-4			3.5		
Turn-on time	$V_{CC} = 5.0\text{ V}, R_L = 75\ \Omega,$ $I_F = 10\text{ mA}$	ILD610-1	t_{on}		3.0		μs
		ILD610-2			3.2		
		ILD610-3			3.6		
		ILD610-4			2.3		
Turn-off time	$V_{CC} = 5.0\text{ V}, R_L = 75\ \Omega,$ $I_F = 10\text{ mA}$	ILD610-1	t_{off}		2.9		μs
		ILD610-2			3.4		
		ILD610-3			3.7		
		ILD610-4			4.1		
SATURATED							
Rise time	$V_{CC} = 5.0\text{ V}, R_L = 1.0\text{ k}\Omega,$ $I_F = 5.0\text{ mA}$	ILD610-1	t_r		2.0		μs
		ILD610-2			2.8		
		ILD610-3			3.3		
		ILD610-4			4.6		
Fall time	$V_{CC} = 5.0\text{ V}, R_L = 1.0\text{ k}\Omega,$ $I_F = 5.0\text{ mA}$	ILD610-1	t_f		11		μs
		ILD610-2			2.6		
		ILD610-3			3.1		
		ILD610-4			15		
Turn-on time	$V_{CC} = 5.0\text{ V}, R_L = 1.0\text{ k}\Omega,$ $I_F = 5.0\text{ mA}$	ILD610-1	t_{on}		3.0		μs
		ILD610-2			4.3		
		ILD610-3			4.6		
		ILD610-4			6.0		
Turn-off time	$V_{CC} = 5.0\text{ V}, R_L = 1.0\text{ k}\Omega,$ $I_F = 5.0\text{ mA}$	ILD610-1	t_{off}		18		μs
		ILD610-2			2.9		
		ILD610-3			3.4		
		ILD610-4			25		

TYPICAL CHARACTERISTICS

$T_{amb} = 25\text{ }^{\circ}\text{C}$, unless otherwise specified

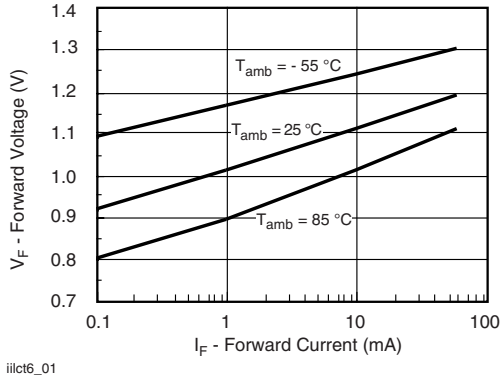

Fig. 1 - Forward Voltage vs. Forward Current

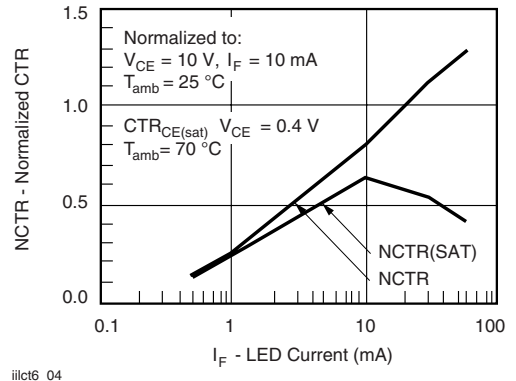

Fig. 4 - Normalized Non-Saturated and Saturated CTR vs. LED Current

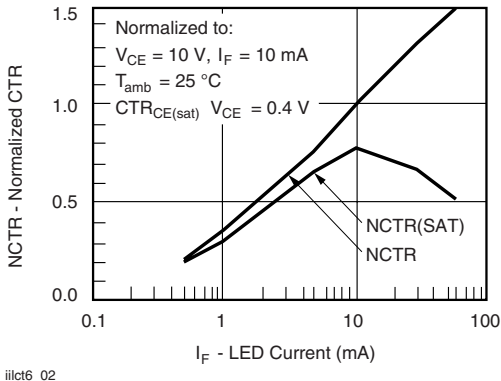

Fig. 2 - Normalized Non-Saturated and Saturated CTR vs. LED Current

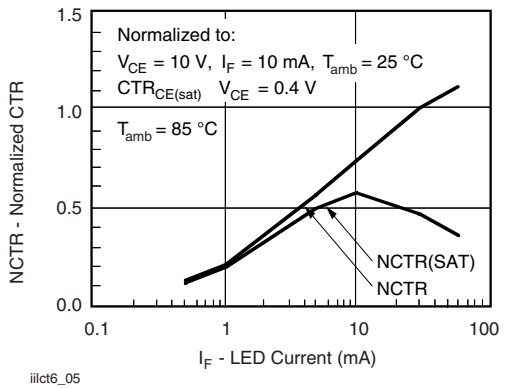

Fig. 5 - Normalized Non-Saturated and Saturated CTR vs. LED Current

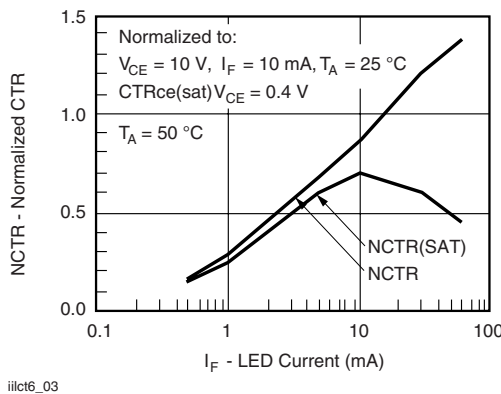

Fig. 3 - Normalized Non-Saturated and Saturated CTR vs. LED Current

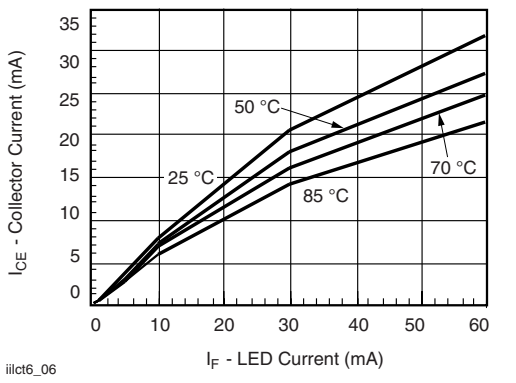
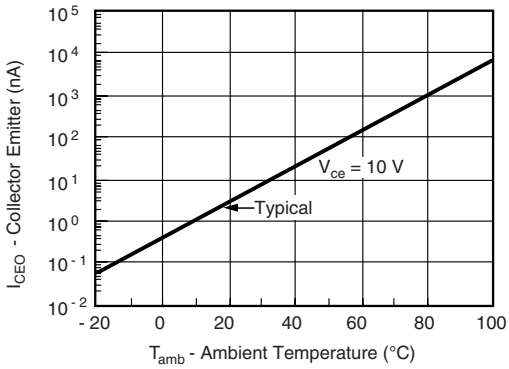
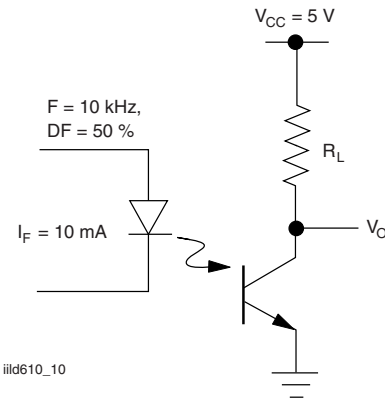

Fig. 6 - Collector Emitter Current vs. Temperature and LED Current



iiict6_07

Fig. 7 - Collector Emitter Leakage Current vs. Temperature



iiid610_10

Fig. 10 - Non-Saturated Switching Schematic

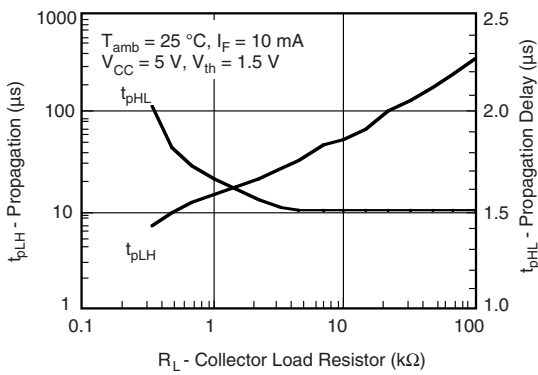

iiict6_08

Fig. 8 - Propagation Delay vs. Collector Load Resistor

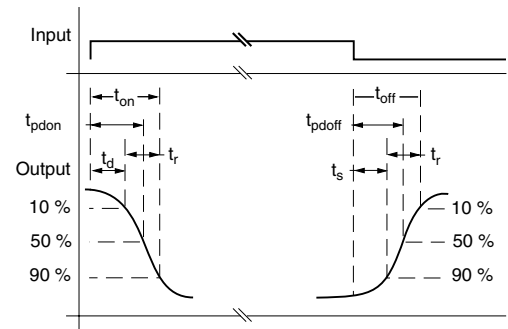

iiid610_11

Fig. 11 - Saturated Switching Time Test Waveform

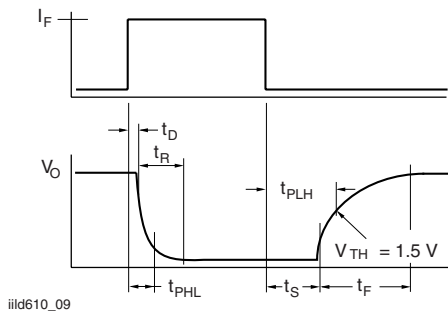

iiid610_09

Fig. 9 - Switching Timing

PACKAGE DIMENSIONS in inches (millimeters)

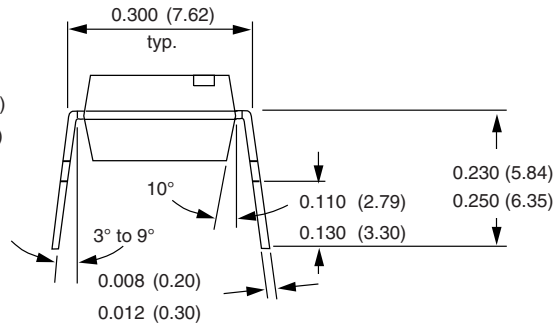
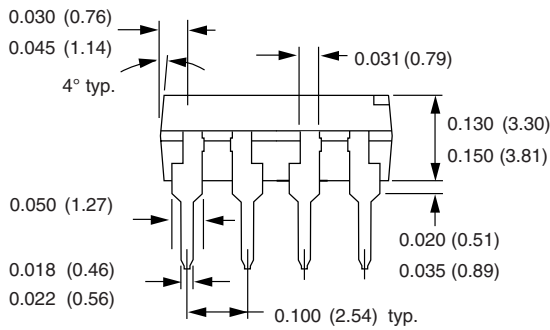
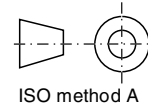
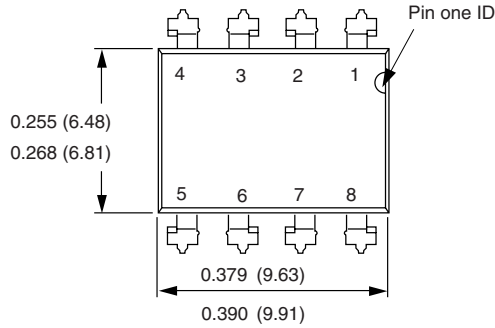

i178006

Option 6

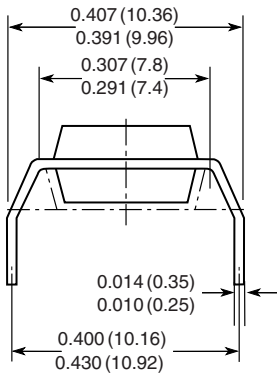

Option 7

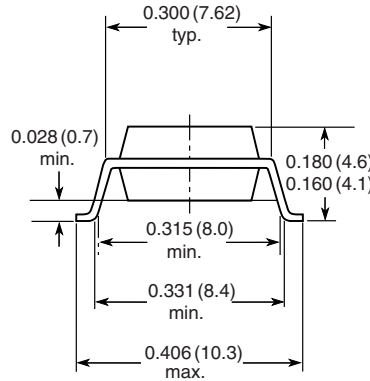

Option 9

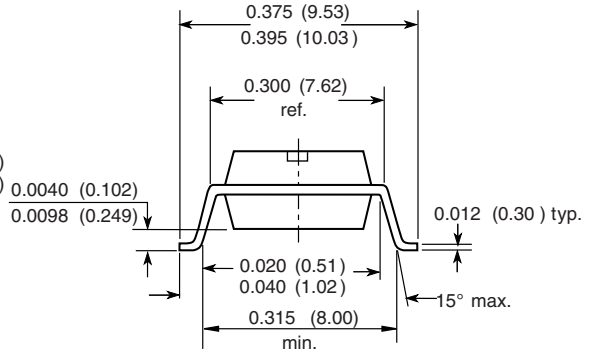

18450

**OZONE DEPLETING SUBSTANCES POLICY STATEMENT**

It is the policy of Vishay Semiconductor GmbH to

1. Meet all present and future national and international statutory requirements.
2. Regularly and continuously improve the performance of our products, processes, distribution and operating systems with respect to their impact on the health and safety of our employees and the public, as well as their impact on the environment.

It is particular concern to control or eliminate releases of those substances into the atmosphere which are known as ozone depleting substances (ODSs).

The Montreal Protocol (1987) and its London Amendments (1990) intend to severely restrict the use of ODSs and forbid their use within the next ten years. Various national and international initiatives are pressing for an earlier ban on these substances.

Vishay Semiconductor GmbH has been able to use its policy of continuous improvements to eliminate the use of ODSs listed in the following documents.

1. Annex A, B and list of transitional substances of the Montreal Protocol and the London Amendments respectively.
2. Class I and II ozone depleting substances in the Clean Air Act Amendments of 1990 by the Environmental Protection Agency (EPA) in the USA.
3. Council Decision 88/540/EEC and 91/690/EEC Annex A, B and C (transitional substances) respectively.

Vishay Semiconductor GmbH can certify that our semiconductors are not manufactured with ozone depleting substances and do not contain such substances.

We reserve the right to make changes to improve technical design
and may do so without further notice.

Parameters can vary in different applications. All operating parameters must be validated for each customer application by the customer. Should the buyer use Vishay Semiconductors products for any unintended or unauthorized application, the buyer shall indemnify Vishay Semiconductors against all claims, costs, damages, and expenses, arising out of, directly or indirectly, any claim of personal damage, injury or death associated with such unintended or unauthorized use.

Vishay Semiconductor GmbH, P.O.B. 3535, D-74025 Heilbronn, Germany



Notice

Specifications of the products displayed herein are subject to change without notice. Vishay Intertechnology, Inc., or anyone on its behalf, assumes no responsibility or liability for any errors or inaccuracies.

Information contained herein is intended to provide a product description only. No license, express or implied, by estoppel or otherwise, to any intellectual property rights is granted by this document. Except as provided in Vishay's terms and conditions of sale for such products, Vishay assumes no liability whatsoever, and disclaims any express or implied warranty, relating to sale and/or use of Vishay products including liability or warranties relating to fitness for a particular purpose, merchantability, or infringement of any patent, copyright, or other intellectual property right.

The products shown herein are not designed for use in medical, life-saving, or life-sustaining applications. Customers using or selling these products for use in such applications do so at their own risk and agree to fully indemnify Vishay for any damages resulting from such improper use or sale.