

## Standard 7- Segment Display 7 mm

### Description

The TDS.11.. series are 7 mm character seven segment LED displays in a very compact package.

The displays are designed for a viewing distance up to 3 meters and available in four bright colors. The grey package surface and the evenly lighted untinted segments provide an optimum on-off contrast.

All displays are categorized in luminous intensity groups. That allows users to assemble displays with uniform appearance. Typical applications include instruments, panel meters, point-of-sale terminals and household equipment.

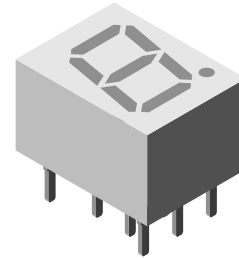

19235

### Features

- Evenly lighted segments
- Grey package surface
- Untinted segments
- Luminous intensity categorized
- Yellow and green categorized for color
- Wide viewing angle
- Suitable for DC and high peak current
- Lead (Pb)-free component
- Component in accordance to RoHS 2002/95/EC and WEEE 2002/96/EC



### Applications

- Panel meters
- Test- and measure- equipment
- Point-of-sale terminals
- Control units

### Parts Table

Part	Color, Luminous Intensity	Circuitry
TDSO1150	Orange red	Common anode
TDSO1160	Orange red	Common cathode
TDSY1150	Yellow	Common anode
TDSG1150	Green	Common anode
TDSG1160	Green	Common cathode

### Absolute Maximum Ratings

$T_{amb} = 25\text{ }^{\circ}\text{C}$ , unless otherwise specified

TDSO1150/1160, TDSY1150, TDSG1150/1160

Parameter	Test condition	Part	Symbol	Value	Unit
Reverse voltage per segment or DP			$V_R$	6	V
DC forward current per segment or DP		TDSO1150	$I_F$	17	mA
		TDSO1160	$I_F$	17	mA
		TDSY1150	$I_F$	17	mA
		TDSG1150	$I_F$	17	mA
		TDSG1160	$I_F$	17	mA
Surge forward current per segment or DP	$t_p \leq 10\text{ }\mu\text{s}$ (non repetitive)	TDSO1150	$I_{FSM}$	0.15	A
		TDSO1160	$I_{FSM}$	0.15	A
		TDSY1150	$I_{FSM}$	0.15	A
		TDSG1150	$I_{FSM}$	0.15	A
		TDSG1160	$I_{FSM}$	0.15	A
Power dissipation	$T_{amb} \leq 45\text{ }^{\circ}\text{C}$		$P_V$	400	mW
Junction temperature			$T_j$	100	$^{\circ}\text{C}$
Operating temperature range			$T_{amb}$	- 40 to + 85	$^{\circ}\text{C}$
Storage temperature range			$T_{stg}$	- 40 to + 85	$^{\circ}\text{C}$
Soldering temperature	$t \leq 3\text{ sec}$ , 2 mm below seating plane		$T_{sd}$	260	$^{\circ}\text{C}$
Thermal resistance LED junction/ambient			$R_{thJA}$	140	K/W

### Optical and Electrical Characteristics

$T_{amb} = 25\text{ }^{\circ}\text{C}$ , unless otherwise specified

#### Orange red

TDSO1150/1160

Parameter	Test condition	Symbol	Min	Typ.	Max	Unit
Luminous intensity per segment (digit average) <sup>1)</sup>	$I_F = 10\text{ mA}$	$I_V$	450			$\mu\text{cd}$
Dominant wavelength	$I_F = 10\text{ mA}$	$\lambda_d$	612		625	nm
Peak wavelength	$I_F = 10\text{ mA}$	$\lambda_p$		630		nm
Angle of half intensity	$I_F = 10\text{ mA}$	$\phi$		$\pm 50$		deg
Forward voltage per segment or DP	$I_F = 20\text{ mA}$	$V_F$		2	3	V
Reverse voltage per segment or DP	$I_R = 10\text{ }\mu\text{A}$	$V_R$	6	15		V

<sup>1)</sup>  $I_{Vmin}$  and  $I_V$  groups are mean

## Yellow

### TDSY1150

Parameter	Test condition	Symbol	Min	Typ.	Max	Unit
Luminous intensity per segment (digit average) <sup>1)</sup>	I <sub>F</sub> = 10 mA	I <sub>V</sub>	450			μcd
Dominant wavelength	I <sub>F</sub> = 10 mA	λ <sub>d</sub>	581		594	nm
Peak wavelength	I <sub>F</sub> = 10 mA	λ <sub>p</sub>		585		nm
Angle of half intensity	I <sub>F</sub> = 10 mA	φ		± 50		deg
Forward voltage per segment or DP	I <sub>F</sub> = 20 mA	V <sub>F</sub>		2.4	3	V
Reverse voltage per segment or DP	I <sub>R</sub> = 10 μA	V <sub>R</sub>	6	15		V

<sup>1)</sup> I<sub>Vmin</sub> and I<sub>V</sub> groups are mean

## Green

### TDSG1150/1160

Parameter	Test condition	Symbol	Min	Typ.	Max	Unit
Luminous intensity per segment (digit average) <sup>1)</sup>	I <sub>F</sub> = 10 mA	I <sub>V</sub>	450			μcd
Dominant wavelength	I <sub>F</sub> = 10 mA	λ <sub>d</sub>	562		575	nm
Peak wavelength	I <sub>F</sub> = 10 mA	λ <sub>p</sub>		565		nm
Angle of half intensity	I <sub>F</sub> = 10 mA	φ		± 50		deg
Forward voltage per segment or DP	I <sub>F</sub> = 20 mA	V <sub>F</sub>		2.4	3	V
Reverse voltage per segment or DP	I <sub>R</sub> = 10 μA	V <sub>R</sub>	6	15		V

<sup>1)</sup> I<sub>Vmin</sub> and I<sub>V</sub> groups are mean

## Typical Characteristics

T<sub>amb</sub> = 25 °C, unless otherwise specified

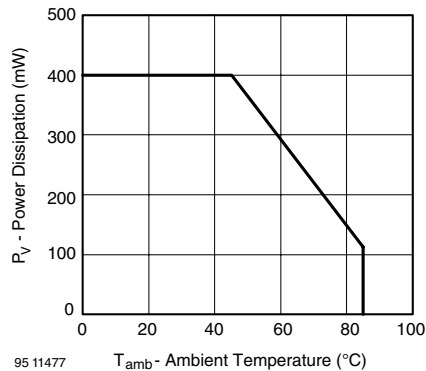

Figure 1. Power Dissipation vs. Ambient Temperature

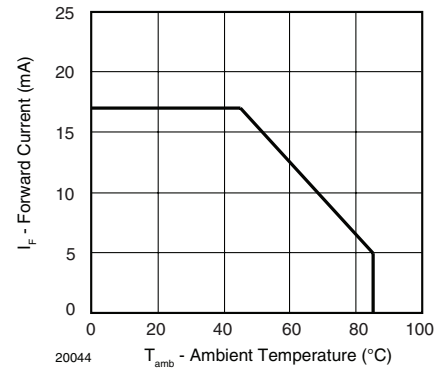

Figure 2. Forward Current vs. Ambient Temperature

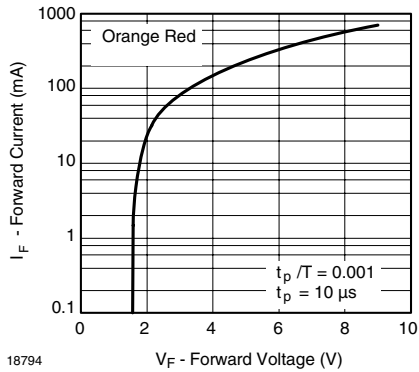

Figure 3. Forward Current vs. Forward Voltage

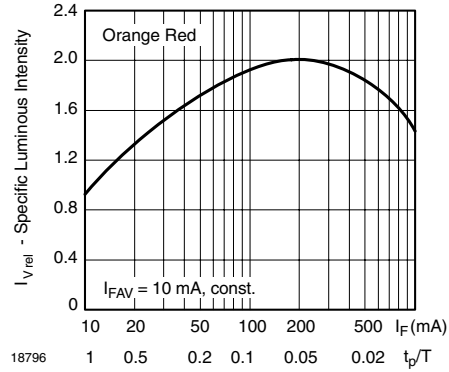

Figure 6. Rel. Lumin. Intensity vs. Forw. Current/Duty Cycle

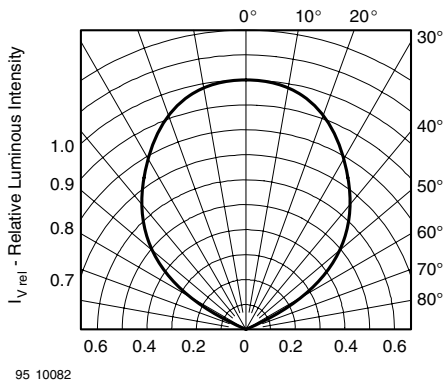

Figure 4. Rel. Luminous Intensity vs. Angular Displacement

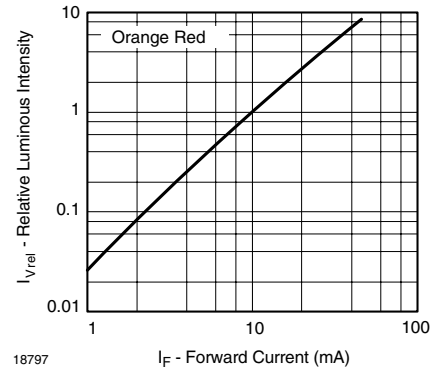

Figure 7. Relative Luminous Intensity vs. Forward Current

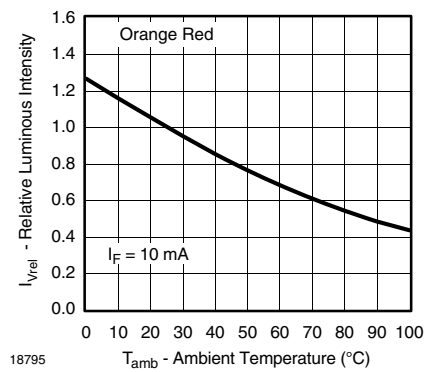

Figure 5. Rel. Luminous Intensity vs. Ambient Temperature

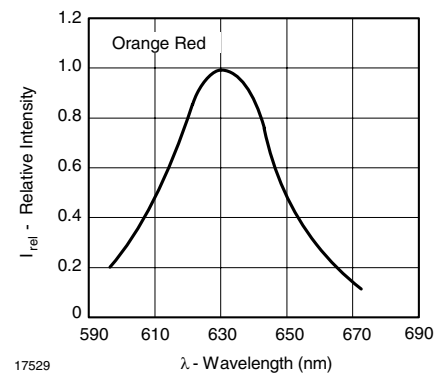

Figure 8. Relative Intensity vs. Wavelength

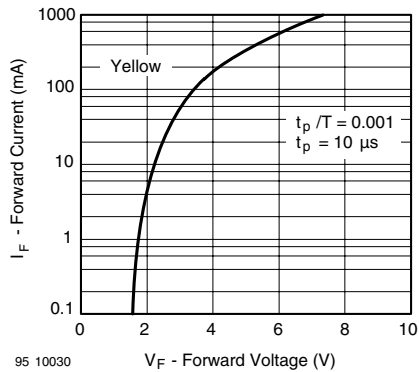

Figure 9. Forward Current vs. Forward Voltage

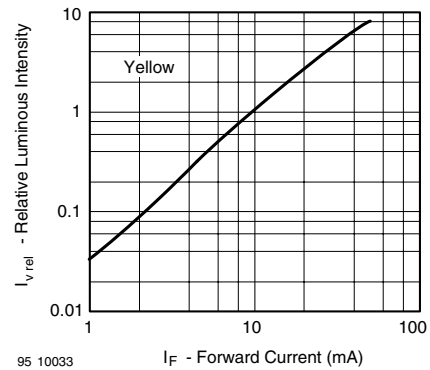

Figure 12. Relative Luminous Intensity vs. Forward Current

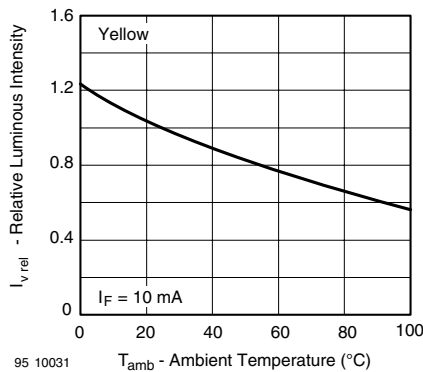

Figure 10. Rel. Luminous Intensity vs. Ambient Temperature

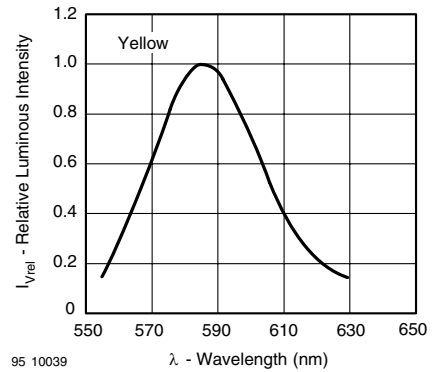

Figure 13. Relative Intensity vs. Wavelength

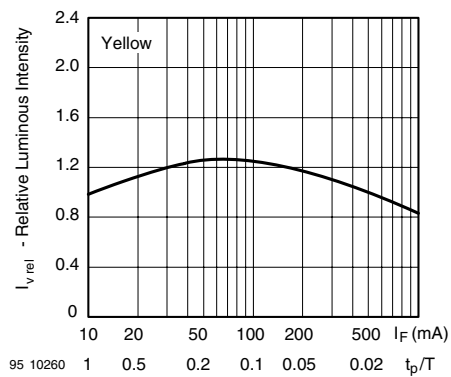

Figure 11. Rel. Lumin. Intensity vs. Forw. Current/Duty Cycle

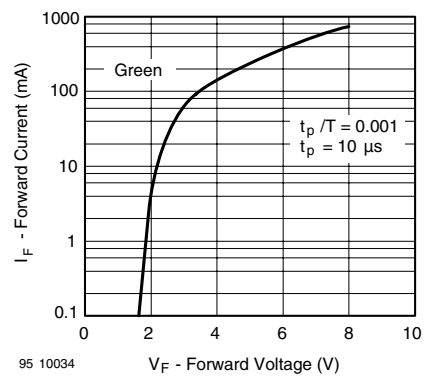

Figure 14. Forward Current vs. Forward Voltage

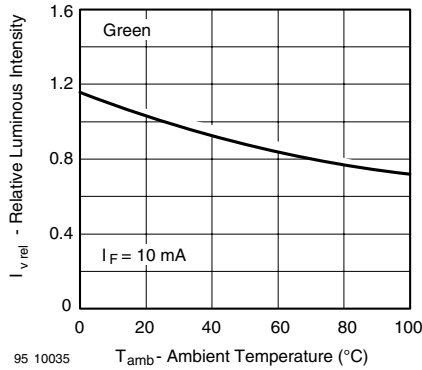

Figure 15. Rel. Luminous Intensity vs. Ambient Temperature

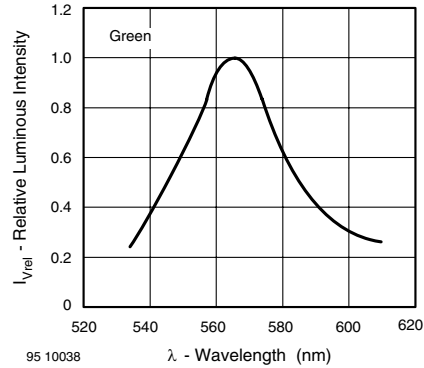

Figure 18. Relative Intensity vs. Wavelength

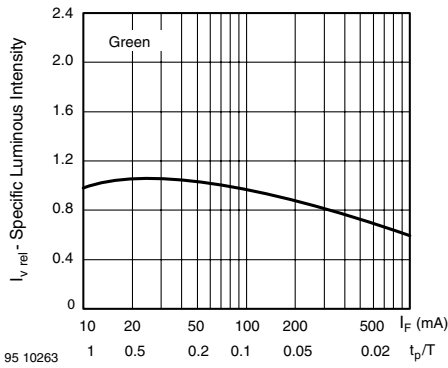

Figure 16. Specific Luminous Intensity vs. Forward Current

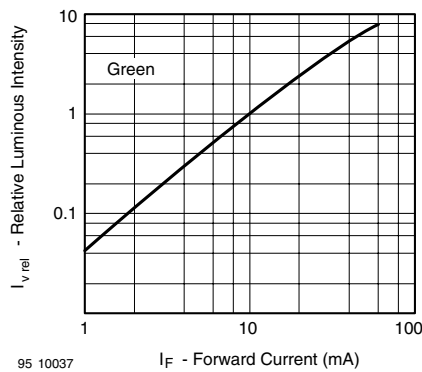
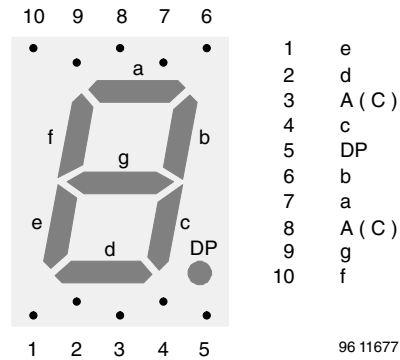
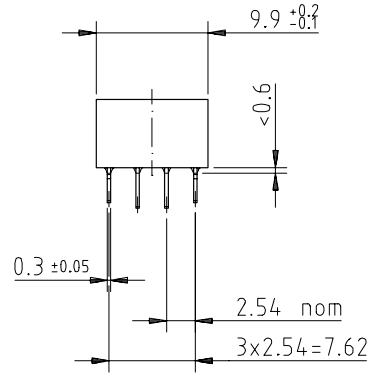
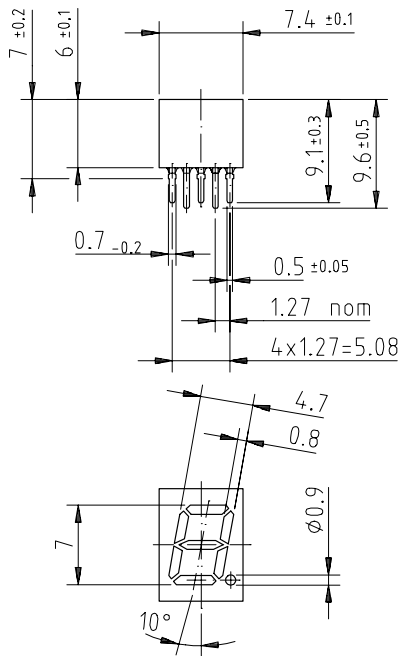
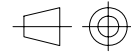

Figure 17. Relative Luminous Intensity vs. Forward Current

## Package Dimensions in mm

technical drawings  
according to DIN  
specifications

95 11342

## Vishay Semiconductors

### Ozone Depleting Substances Policy Statement

It is the policy of Vishay Semiconductor GmbH to

1. Meet all present and future national and international statutory requirements.
2. Regularly and continuously improve the performance of our products, processes, distribution and operating systems with respect to their impact on the health and safety of our employees and the public, as well as their impact on the environment.

It is particular concern to control or eliminate releases of those substances into the atmosphere which are known as ozone depleting substances (ODSs).

The Montreal Protocol (1987) and its London Amendments (1990) intend to severely restrict the use of ODSs and forbid their use within the next ten years. Various national and international initiatives are pressing for an earlier ban on these substances.

Vishay Semiconductor GmbH has been able to use its policy of continuous improvements to eliminate the use of ODSs listed in the following documents.

1. Annex A, B and list of transitional substances of the Montreal Protocol and the London Amendments respectively
2. Class I and II ozone depleting substances in the Clean Air Act Amendments of 1990 by the Environmental Protection Agency (EPA) in the USA
3. Council Decision 88/540/EEC and 91/690/EEC Annex A, B and C (transitional substances) respectively.

Vishay Semiconductor GmbH can certify that our semiconductors are not manufactured with ozone depleting substances and do not contain such substances.

We reserve the right to make changes to improve technical design  
and may do so without further notice.

Parameters can vary in different applications. All operating parameters must be validated for each customer application by the customer. Should the buyer use Vishay Semiconductors products for any unintended or unauthorized application, the buyer shall indemnify Vishay Semiconductors against all claims, costs, damages, and expenses, arising out of, directly or indirectly, any claim of personal damage, injury or death associated with such unintended or unauthorized use.

Vishay Semiconductor GmbH, P.O.B. 3535, D-74025 Heilbronn, Germany





## Notice

Specifications of the products displayed herein are subject to change without notice. Vishay Intertechnology, Inc., or anyone on its behalf, assumes no responsibility or liability for any errors or inaccuracies.

Information contained herein is intended to provide a product description only. No license, express or implied, by estoppel or otherwise, to any intellectual property rights is granted by this document. Except as provided in Vishay's terms and conditions of sale for such products, Vishay assumes no liability whatsoever, and disclaims any express or implied warranty, relating to sale and/or use of Vishay products including liability or warranties relating to fitness for a particular purpose, merchantability, or infringement of any patent, copyright, or other intellectual property right.

The products shown herein are not designed for use in medical, life-saving, or life-sustaining applications. Customers using or selling these products for use in such applications do so at their own risk and agree to fully indemnify Vishay for any damages resulting from such improper use or sale.