



DS4802

Low Voltage, Micro Power, High Performance, Rail-To-Rail Dual Op-Amp

www.dalsemi.com

FEATURES

- Very low operating power:
12 μ A typical per amplifier
- High output sink/source capability
- Supply Voltage Range 1.8 to 5.5V
- Rail-to-Rail Output Swing
- Input offset voltage: 0.95 mV max.

ORDERING INFORMATION

Part Number	Description
DS4802	8-pin DIP
DS4802S	8-pin SOIC
DS4802U	8-pin μ -SOP
DS4802X	8-bump Flip-Chip

For mechanical dimensions see website.

DESCRIPTION

The DS4802 BiCMOS dual operational amplifier combines low input offset voltage, very low power consumption, rail-to-rail output swing, and excellent DC precision. With a maximum input offset voltage of 0.95 mV, a maximum I_{DD} of 25 μ A/amplifier, and 10 pA typical input bias current, the DS4802 is ideal for measurement, medical, and industrial applications. The DS4802 is also ideal for portable applications with 1.8 volt to 5.5 volt single supply voltage operation and low power consumption.

PACKAGES/PINOUTS

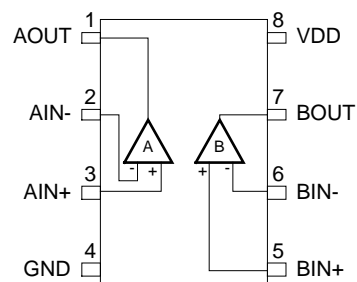

300-mil DIP
150-mil SOIC
118-mil μ -SOP

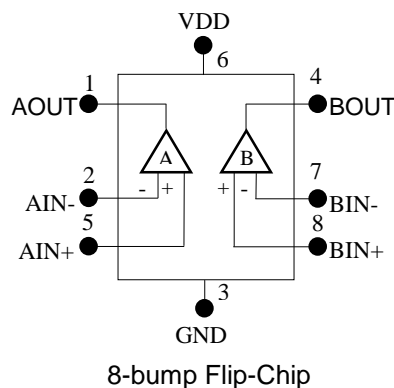

8-bump Flip-Chip

ABSOLUTE MAXIMUM RATINGS

Supply Voltage, V_{DD} (see Note 1)	5.5V
Differential Input Voltage (see Note 2)	$\pm V_{DD}$
Input Voltage Range, V_I (see Note 1)	-0.3V to V_{DD}
Input Current, I_{DD}	± 4 mA
Output Current, I_O	± 50 mA
Total current into V_{DD}	± 50 mA
Total current out of GND	± 50 mA
Duration of short-circuit current (See Note 3)	unlimited
Operating Temperature	0°C to 70°C
Storage Temperature	-55°C to +125°C
Soldering Temperature	260°C for 10 seconds

Notes:

1. Relative to GND.
2. Non-inverting input relative to inverting input. Excessive current flows when input is brought below GND - 0.3V.
3. The output may be shorted to either supply. Temperature and/or supply voltages must be limited to ensure that the maximum dissipation rating is not exceeded.

RECOMMENDED OPERATING CONDITIONS

PARAMETER	SYMBOL	MIN	TYP	MAX	UNITS	NOTES
Supply Voltage	V_{DD}	1.8		5.5	V	1
Input Voltage Range	V_I	GND		$V_{DD} - 1.0$	V	1
Common-Mode Input Voltage	V_{IC}	GND		$V_{DD} - 1.0$	V	
Free-Air Operating Temperature	T_A	0		70	°C	

Notes:

1. Voltage referenced to GND.

ELECTRICAL CHARACTERISTICS

(TA: 0°C – 70°C. VDD = 1.8V)

PARAMETER	SYMBOL	MIN	TYP	MAX	UNITS	NOTES
Input Offset Voltage ($V_{IC} = 0.5V$, $R_S = 50\Omega$, $V_{OUT} = V_{DD}/2$)	V_{IO}		0.1	0.95	mV	
Temperature Coefficient of Input Offset Voltage ($V_{IC} = 0.5V$, $R_S = 50\Omega$, $V_{OUT} = V_{DD}/2$)	αV_{IO}		2		$\mu V/^\circ C$	
Input Offset Current ($R_S = 50\Omega$)	I_{IO}		5	500	pA	
Input Bias Current ($R_S = 50\Omega$)	I_{IB}		10	500	pA	
Common-mode Input Voltage Range ($ V_{IO} \leq 5\text{ mV}$, $R_S = 50\Omega$)	V_{ICR}	0 to 1	-0.3 to 1.2		V	
High Level Output Voltage ($I_{OH} = -50\ \mu A$) ($I_{OH} = -500\ \mu A$)	V_{OH}		1.785 1.65		V	
Low Level Output Voltage ($I_{OL} = 50\ \mu A$) ($I_{OL} = 500\ \mu A$)	V_{OL}		10 100	200	mV	
Large Signal Differential Voltage Amplification ($V_{IC} = 0.5V$, $0.4V \leq V_O \leq 1.4V$) $R_L = 100\text{ k}\Omega$ ($V_{IC} = 0.5V$, $0.4V \leq V_O \leq 1.4V$) $R_L = 10\text{ k}\Omega$	A_{VD}	65 55	75 65		dB	
Input Resistance	R_{IN}		$>10^{12}$		Ω	
Common Mode Input Capacitance	$C_{i(c)}$		24.0		pF	
Common Mode Rejection Ratio ($0V \leq V_{IC} \leq 0.8V$, $R_S = 50\Omega$, $V_O = V_{DD}/2$)	CMRR	60	75		dB	
Supply Voltage Rejection Ratio ($1.8V \leq V_{DD} \leq 3.6V$, $V_{IC} = V_{DD}/2$, no load)	k_{SVR}	70	85		dB	
Amplifier Supply Current (per channel) ($V_O = V_{DD}/2$, no load)	I_{DD}		12	25	μA	
Slew Rate at Unity Gain ($R_L = 100\text{ k}\Omega$, $C_L = 100\text{ pF}$ tied to $V_{DD}/2$)	SR	10	15		V/ms	

PARAMETER	SYMBOL	MIN	TYP	MAX	UNITS	NOTES
Equivalent Input Noise Voltage (f = 10 Hz) (f = 1 kHz)	V_N		120 60		nV/ $\sqrt{\text{Hz}}$	
Unity Gain Bandwidth Product ($R_L = 100 \text{ k}\Omega$, $C_L = 100 \text{ pF}$ tied to $V_{DD}/2$)	UGBW		31		kHz	
Phase Margin at Unity Gain ($R_L = 100 \text{ k}\Omega$, $C_L = 100 \text{ pF}$ tied to $V_{DD}/2$)	ϕ_M		60		Degree	
Gain Margin ($R_L = 100 \text{ k}\Omega$, $C_L = 100 \text{ pF}$ tied to $V_{DD}/2$)			17		dB	

ELECTRICAL CHARACTERISTICS cont. ($T_A: 0^\circ\text{C} - 70^\circ\text{C}$, $V_{DD} = 3.0\text{V}$)

PARAMETER	SYMBOL	MIN	TYP	MAX	UNITS	NOTES
Input Offset Voltage ($V_{IC} = 1.5\text{V}$, $R_S = 50\Omega$, $V_{OUT} = V_{DD}/2$)	V_{IO}		0.1	0.95	mV	
Temperature Coefficient of Input Offset Voltage ($V_{IC} = 1.5\text{V}$, $R_S = 50\Omega$, $V_{OUT} = V_{DD}/2$)	αV_{IO}		2		$\mu\text{V}/^\circ\text{C}$	
Input Offset Current ($R_S = 50\Omega$)	I_{IO}		5	500	pA	
Input Bias Current ($R_S = 50\Omega$)	I_{IB}		10	500	pA	
Common-mode Input Voltage Range ($ V_{IO} \leq 5 \text{ mV}$, $R_S = 50\Omega$)	V_{ICR}	0 to 2	-0.3 to 2.2		V	
High Level Output Voltage ($I_{OH} = -200 \mu\text{A}$) ($I_{OH} = -2 \text{ mA}$)	V_{OH}		2.97 2.7		V	
Low Level Output Voltage ($V_{IC} = 1.5\text{V}$, $I_{OL} = 200 \mu\text{A}$) ($V_{IC} = 1.5\text{V}$, $I_{OL} = 2 \text{ mA}$)	V_{OL}		24 240	500	mV	
Large Signal Differential Voltage Amplification ($V_{IC} = 1.5\text{V}$, $0.5\text{V} \leq V_O \leq 2.5\text{V}$) $R_L = 100 \text{ k}\Omega$ ($V_{IC} = 1.5\text{V}$, $0.5\text{V} \leq V_O \leq 2.5\text{V}$) $R_L = 10\text{k}\Omega$	A_{VD}	70 60	80 70		dB	
Input Resistance	R_{IN}		$>10^{12}$		Ω	
Common Mode Input Capacitance	$C_{I(c)}$		24.0		pF	
Common Mode Rejection Ratio	CMRR	65	80		dB	

PARAMETER	SYMBOL	MIN	TYP	MAX	UNITS	NOTES
($0V \leq V_{IC} \leq 2V$, $R_S = 50\Omega$, $V_O = V_{DD}/2$)						
Supply Voltage Rejection Ratio ($1.8V \leq V_{DD} \leq 3.6V$, $V_{IC} = V_{DD}/2$, no load)	k_{SVR}	70	85		dB	
Amplifier Supply Current (per channel) ($V_O = V_{DD}/2$, no load)	I_{DD}		12	25	μA	
Slew Rate at Unity Gain ($R_L = 100\text{ k}\Omega$, $C_L = 100\text{ pF}$ tied to $V_{DD}/2$)	SR	10	15		V/ms	
Equivalent Input Noise Voltage ($f = 10\text{ Hz}$) ($f = 1\text{ kHz}$)	V_N		120 60		$nV/\sqrt{\text{Hz}}$	
Unity Gain Bandwidth Product ($R_L = 100\text{ k}\Omega$, $C_L = 100\text{ pF}$ tied to $V_{DD}/2$)	UGBW		35		kHz	
Phase Margin at Unity Gain ($R_L = 100\text{ k}\Omega$, $C_L = 100\text{ pF}$ tied to $V_{DD}/2$)	ϕ_M		60		Degree	
Gain Margin ($R_L = 100\text{ k}\Omega$, $C_L = 100\text{ pF}$ tied to $V_{DD}/2$)			17		dB	

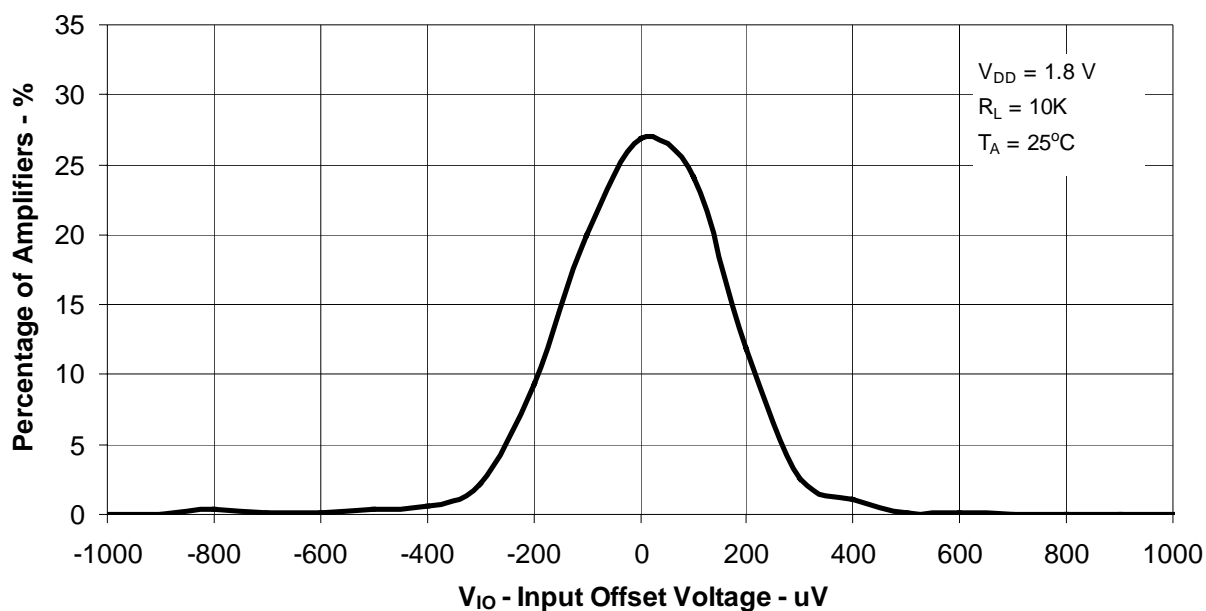
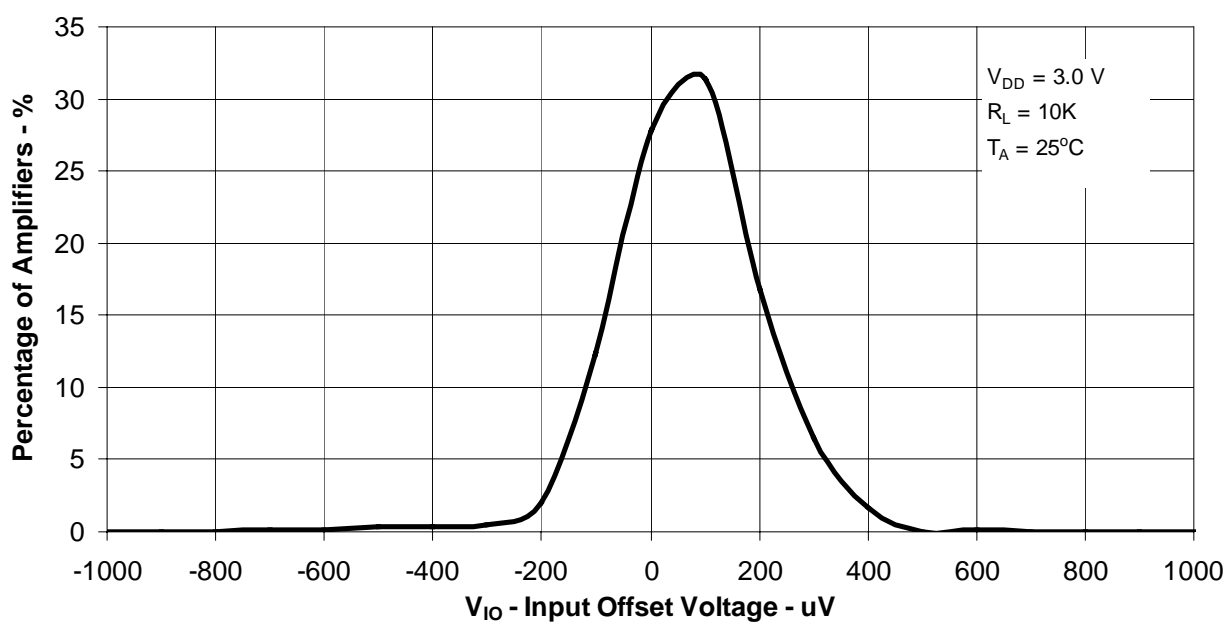
**DISTRIBUTION OF DS4802
INPUT OFFSET VOLTAGE****Figure 1.0****DISTRIBUTION OF DS4802
INPUT OFFSET VOLTAGE****Figure 2.0**

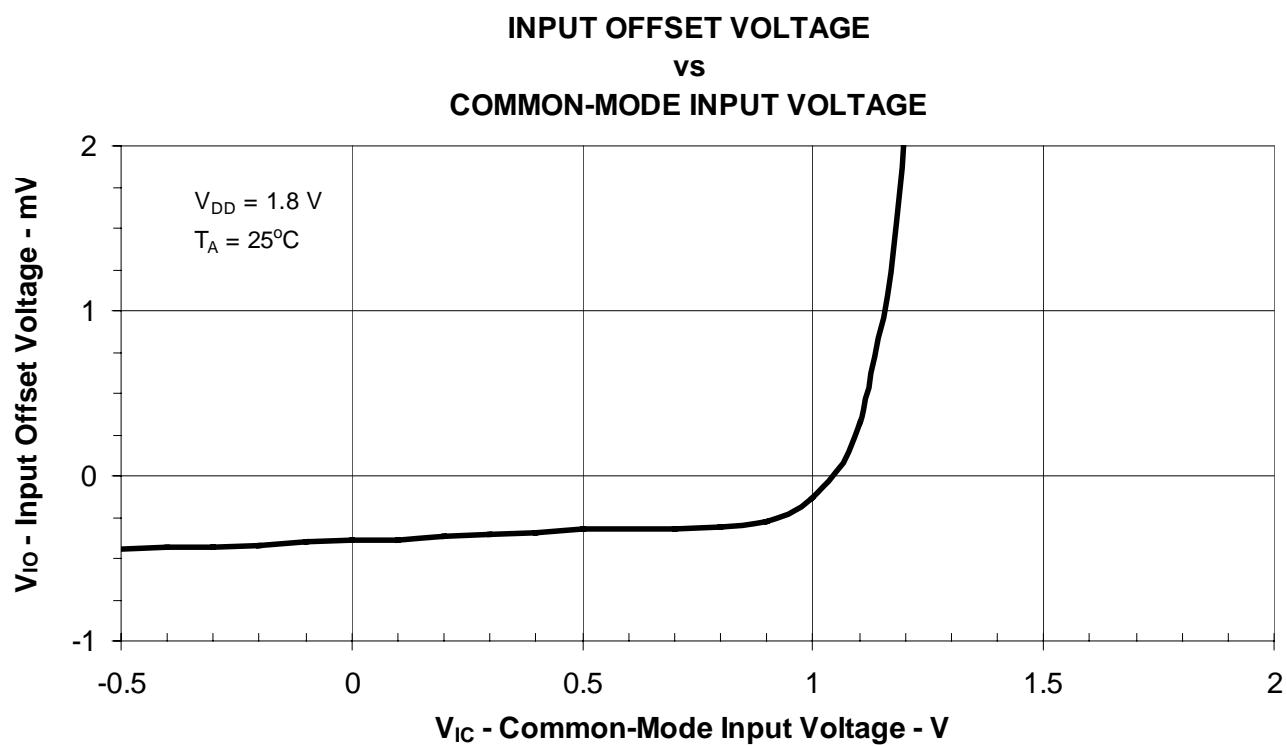

Figure 3.0

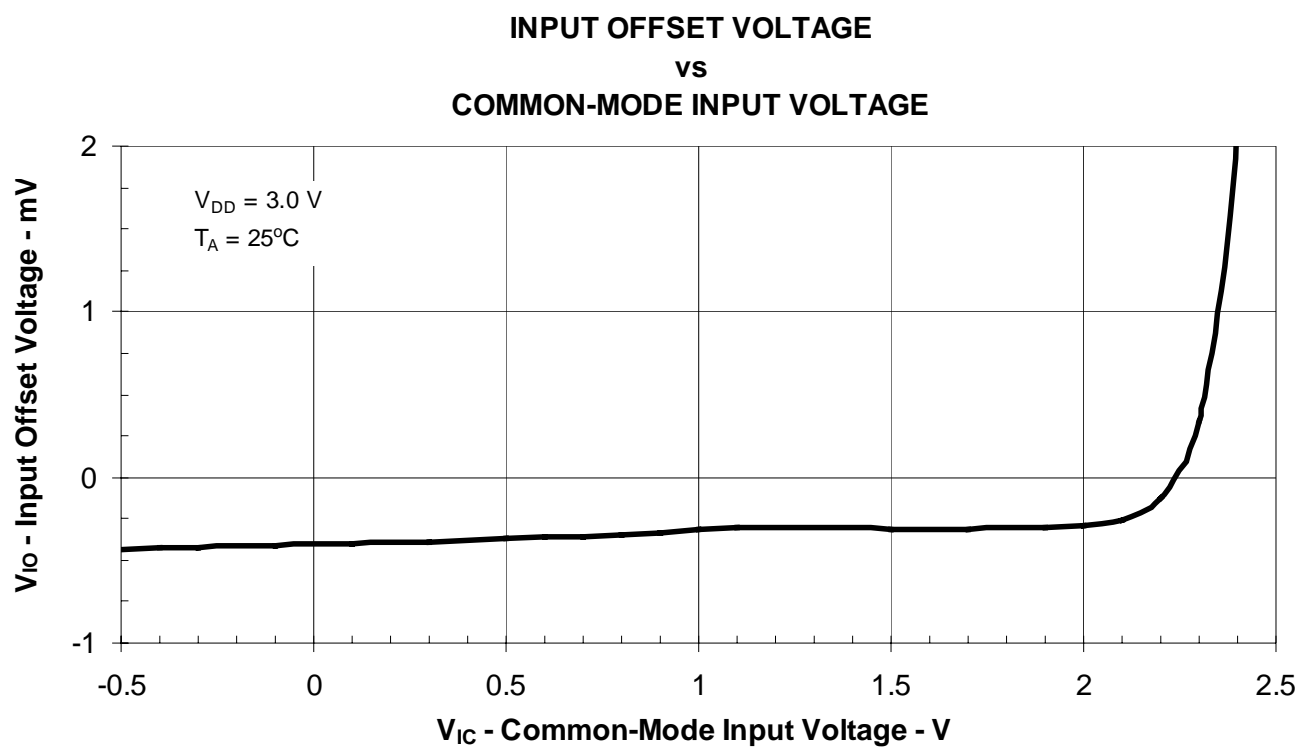

Figure 4.0

**DISTRIBUTION OF DS4802
INPUT OFFSET VOLTAGE
TEMPERATURE COEFFICIENT**

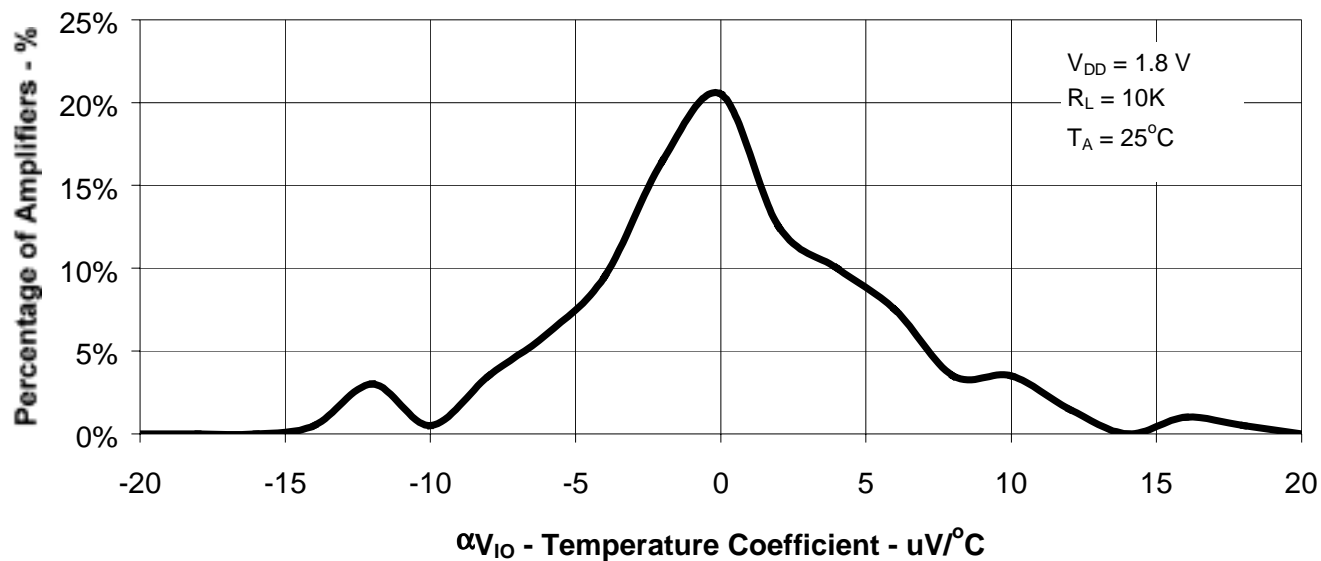

Figure 5.0

**DISTRIBUTION OF DS4802
INPUT OFFSET VOLTAGE
TEMPERATURE COEFFICIENT**

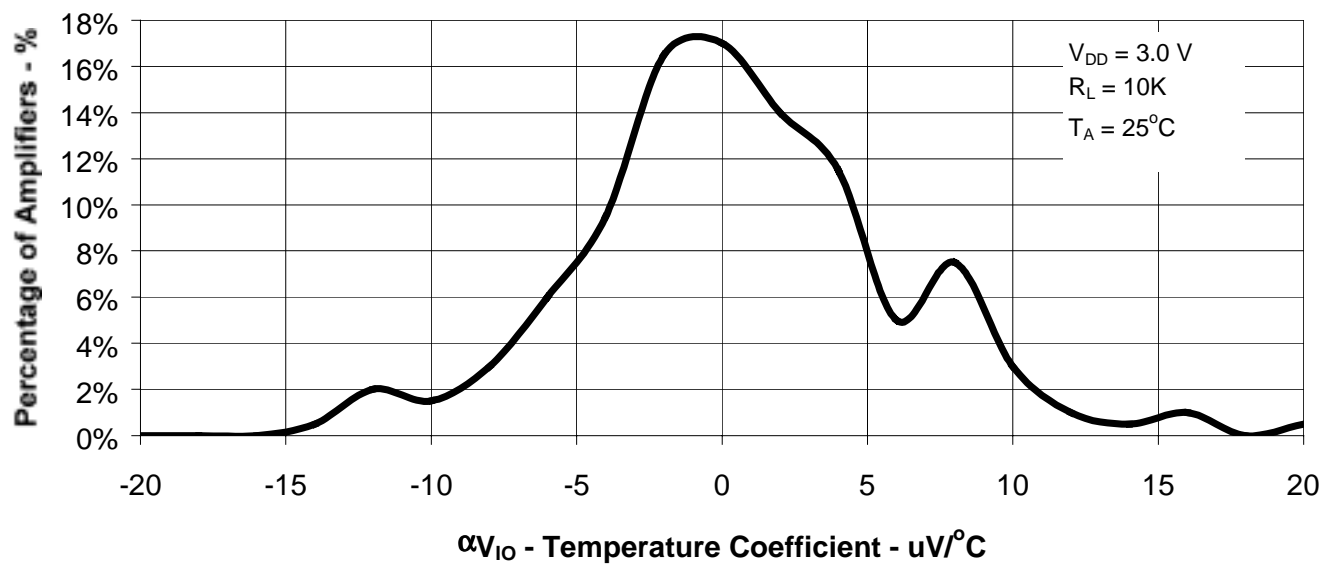
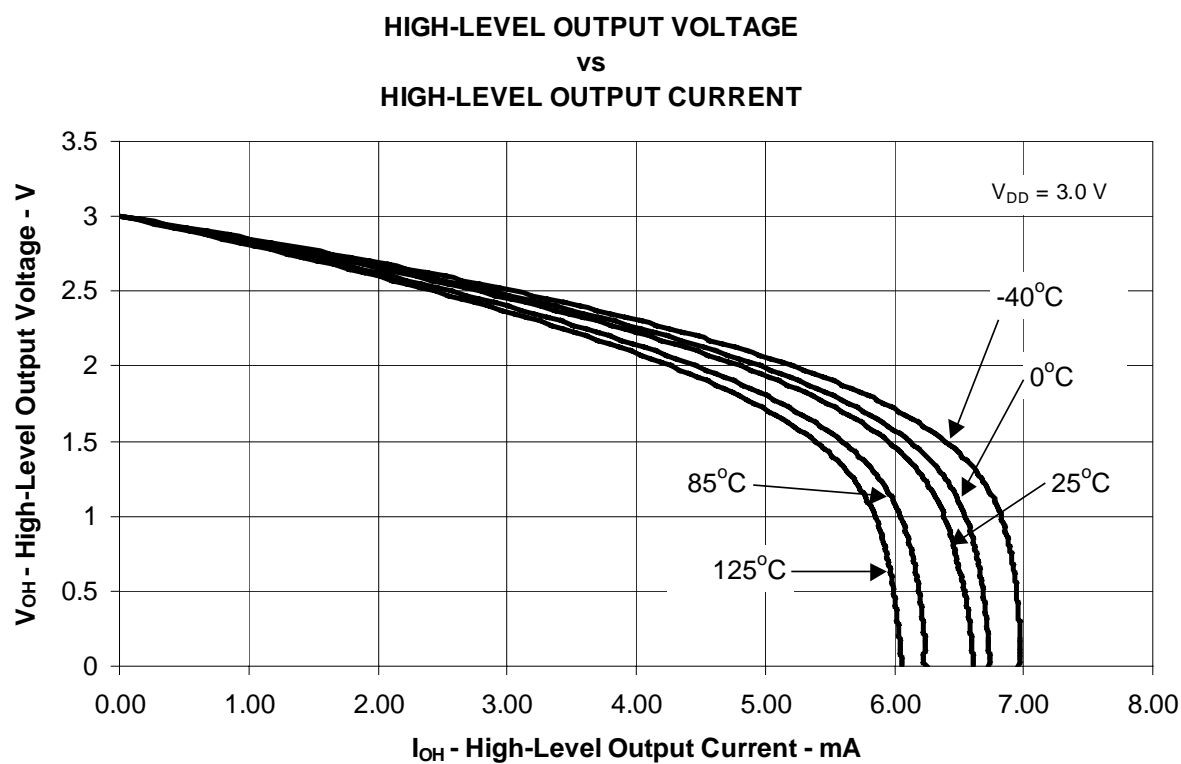
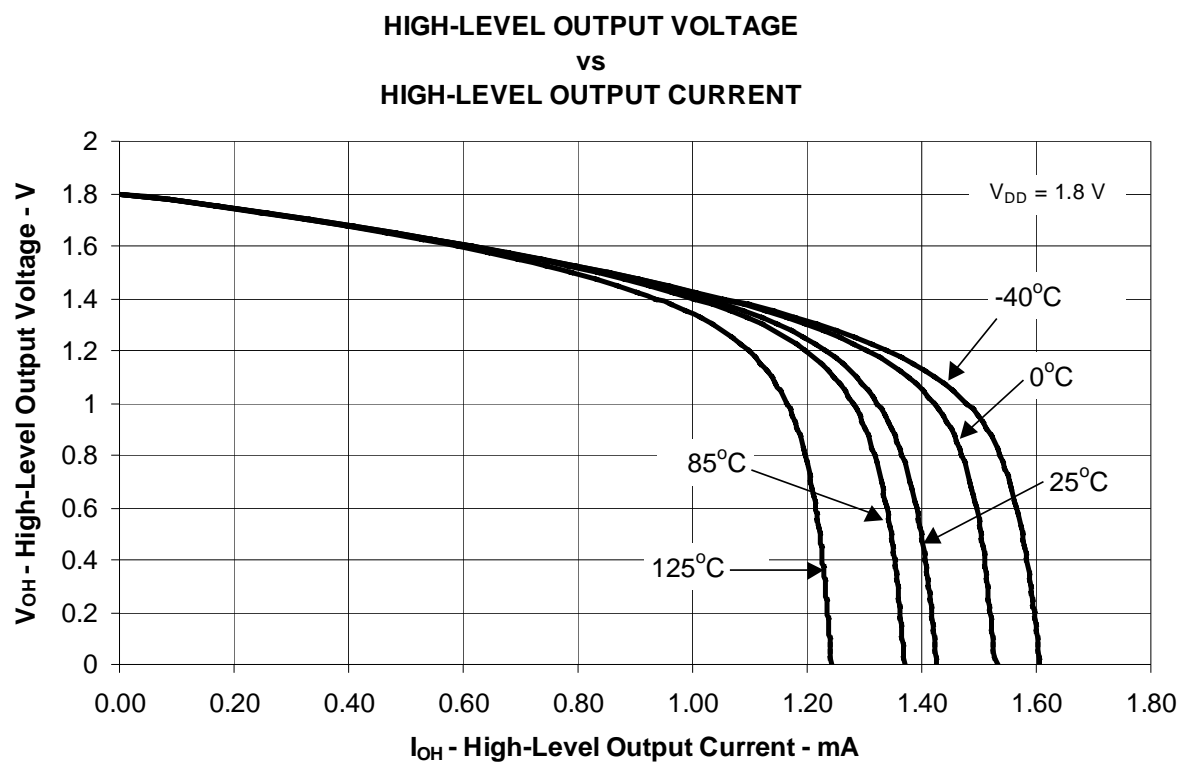

Figure 6.0



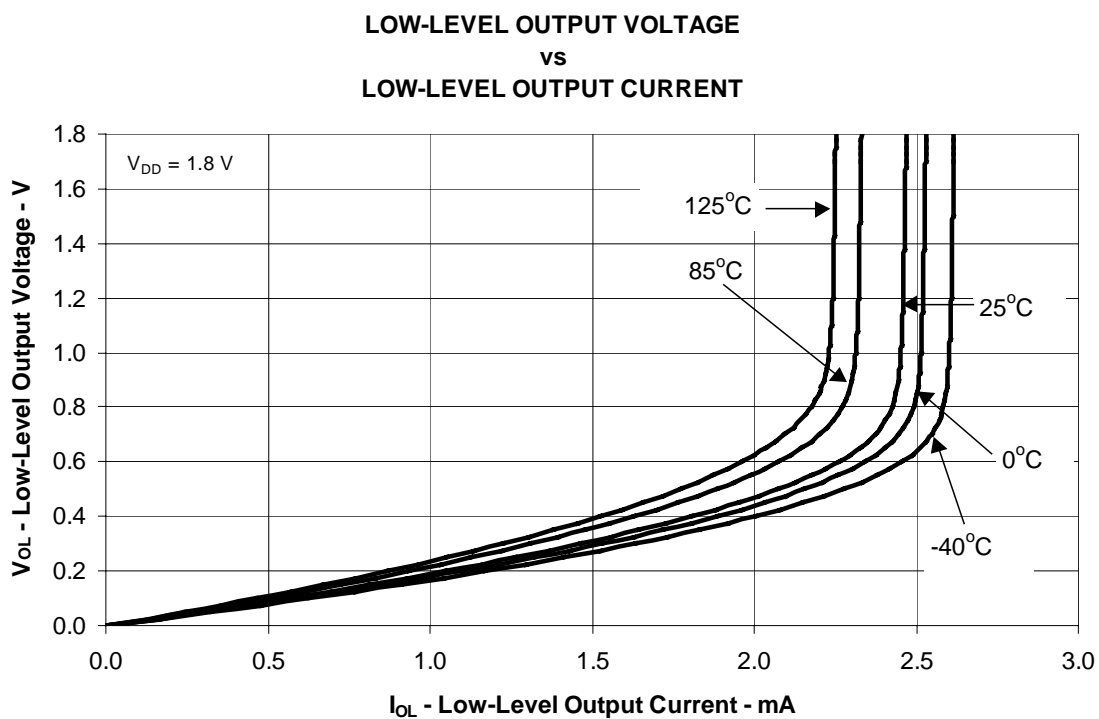

Figure 9.0

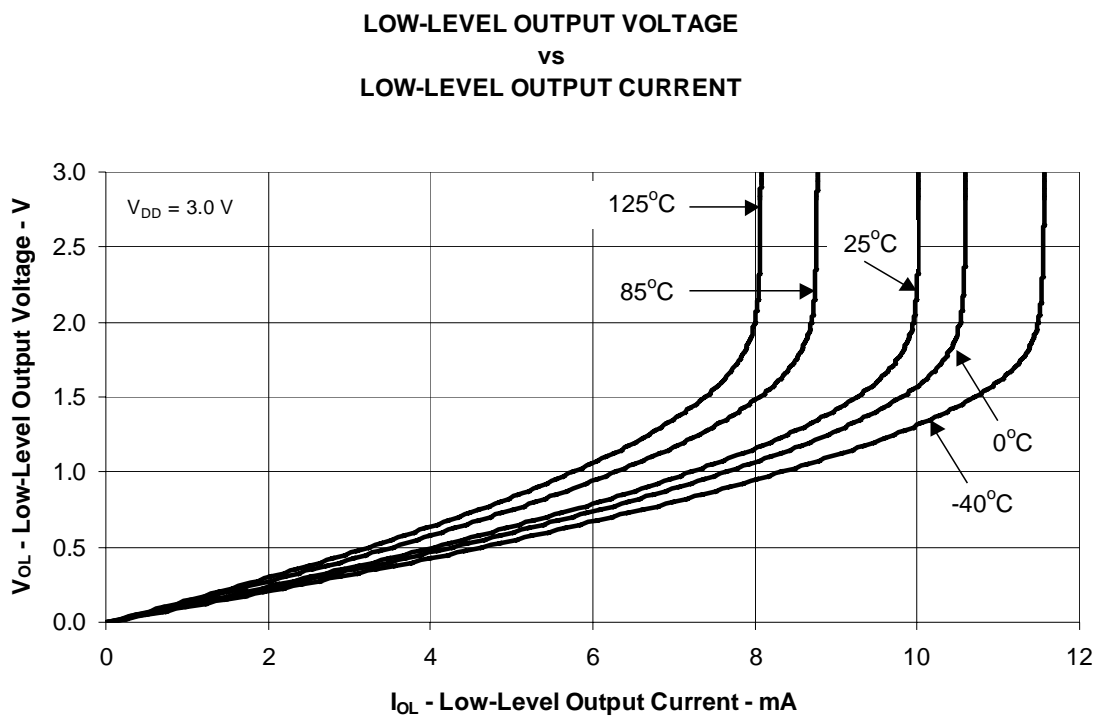

Figure 10.0

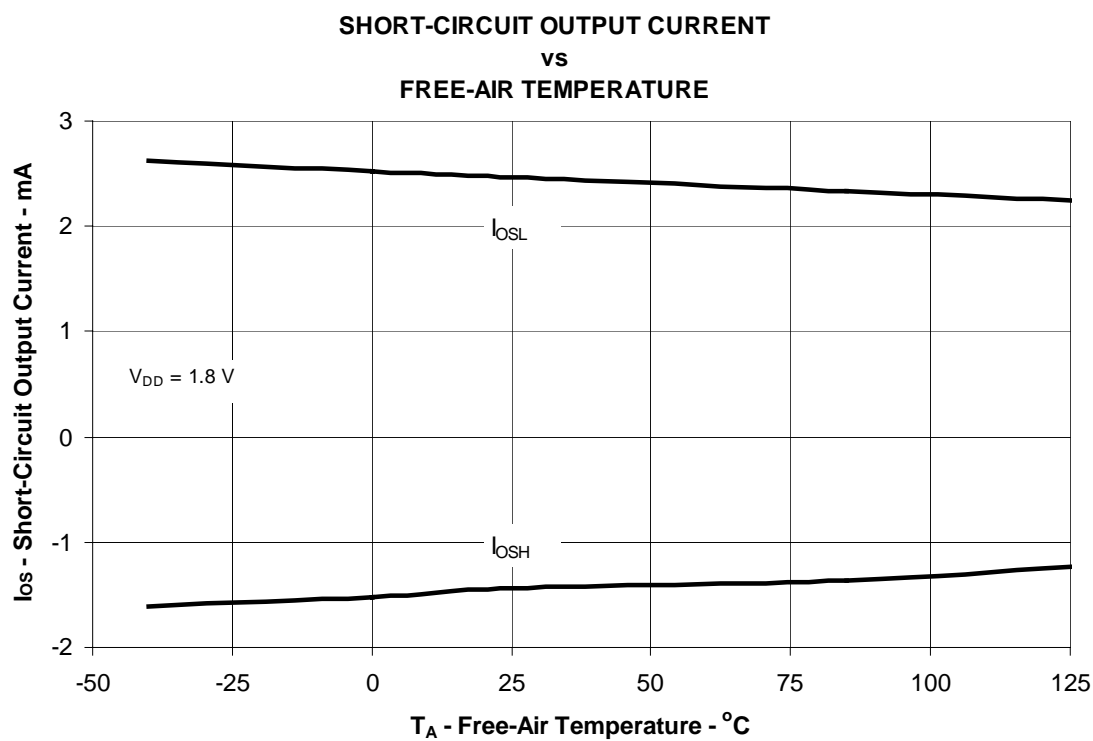

Figure 11.0

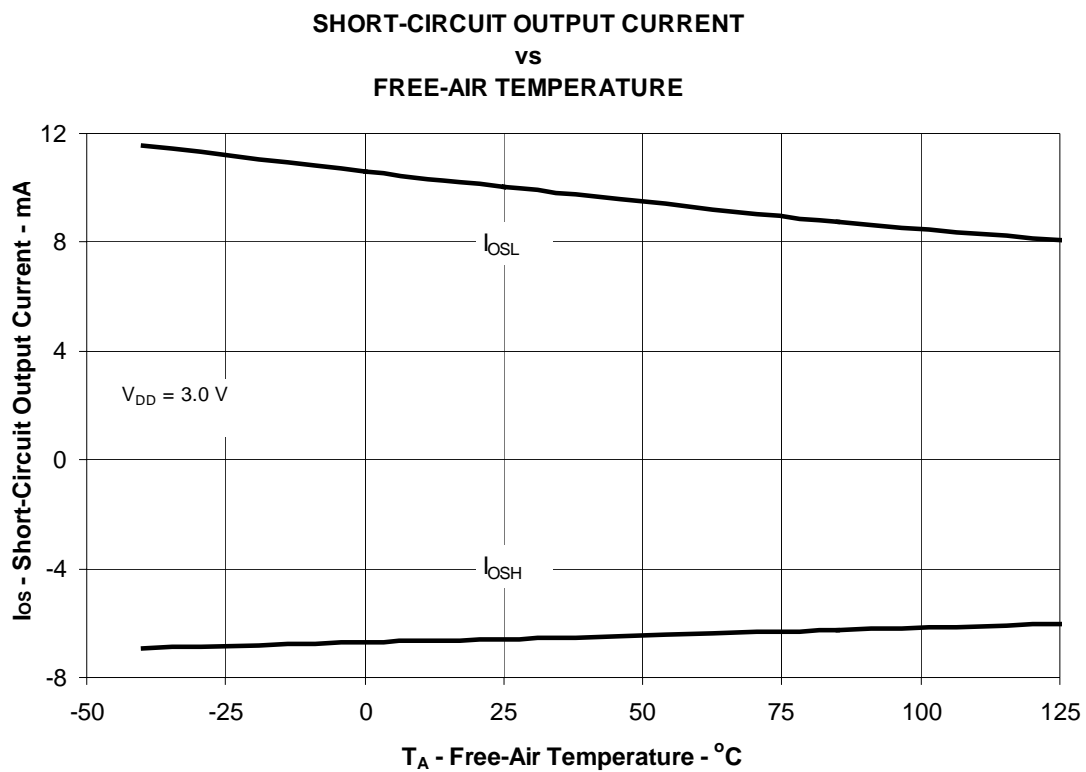

Figure 12.0

**LARGE-SIGNAL DIFFERENTIAL VOLTAGE AMPLIFICATION
AND PHASE MARGIN
vs
FREQUENCY**

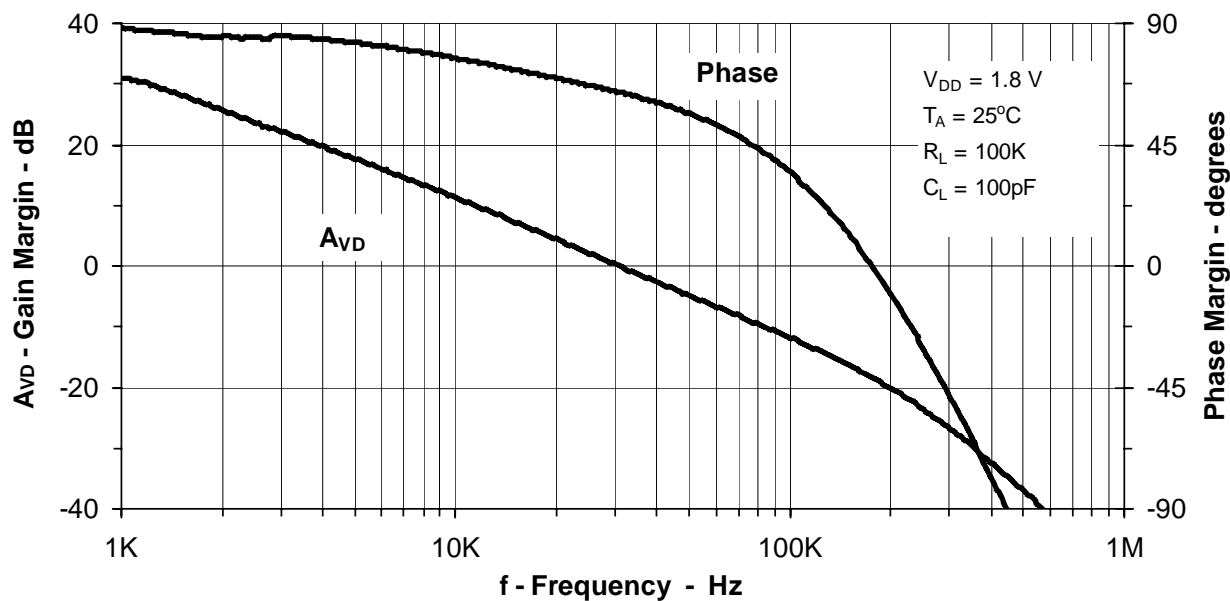

Figure 13.0

**LARGE-SIGNAL DIFFERENTIAL VOLTAGE AMPLIFICATION
AND PHASE MARGIN
vs
FREQUENCY**

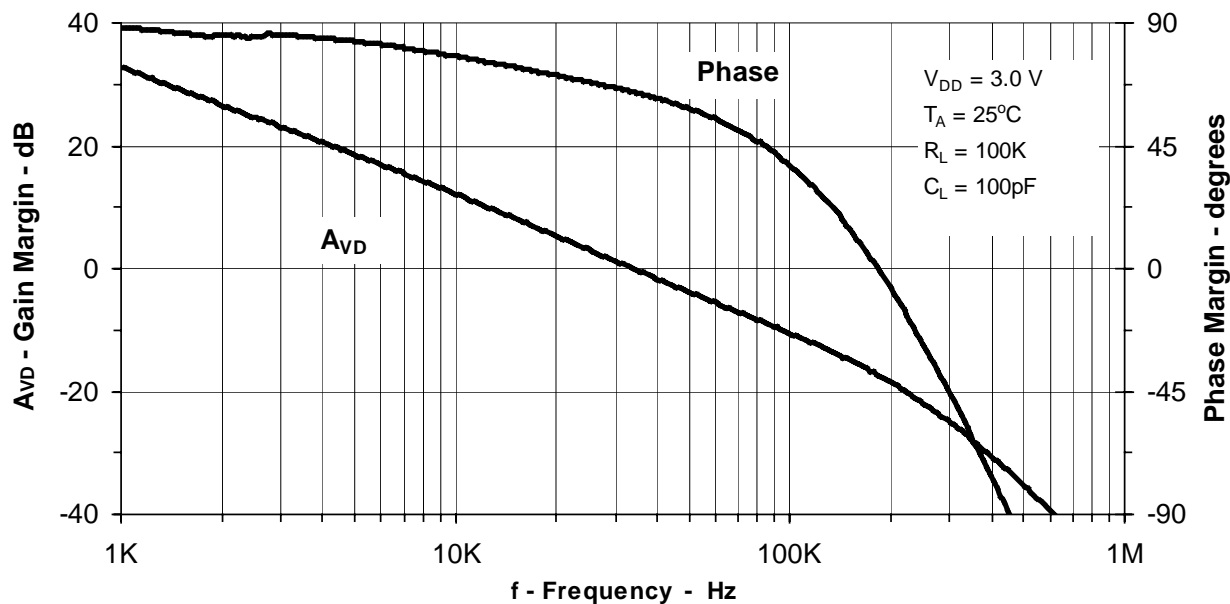

Figure 14.0

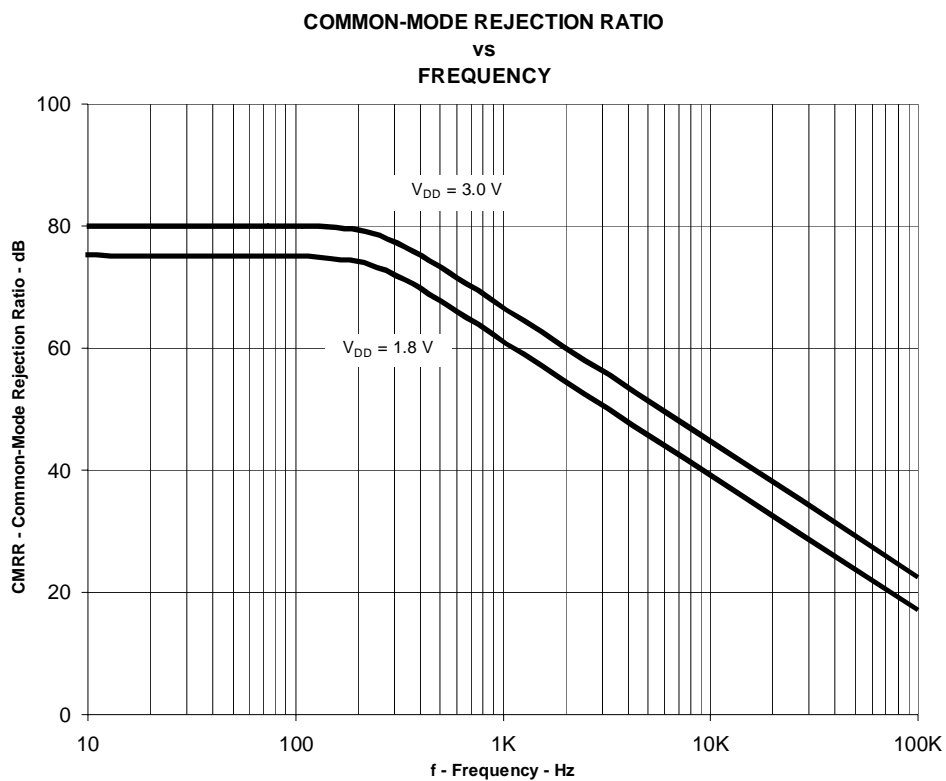

Figure 15.0

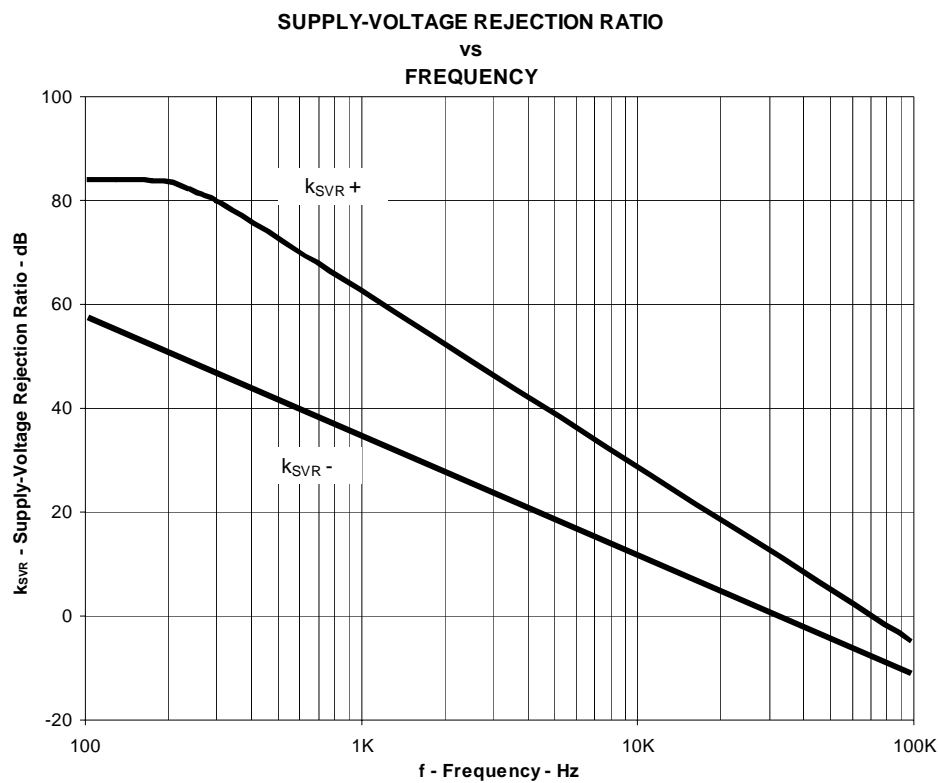

Figure 16.0

VOLTAGE-FOLLOWER SMALL-SIGNAL PULSE RESPONSE

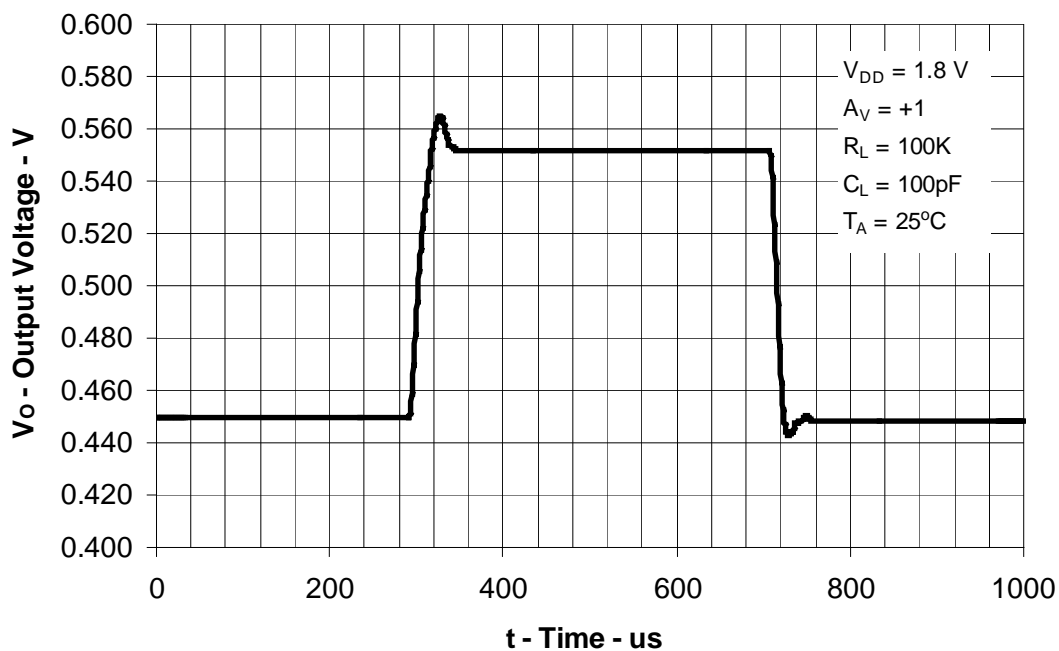

Figure 17.0

VOLTAGE-FOLLOWER SMALL-SIGNAL PULSE RESPONSE

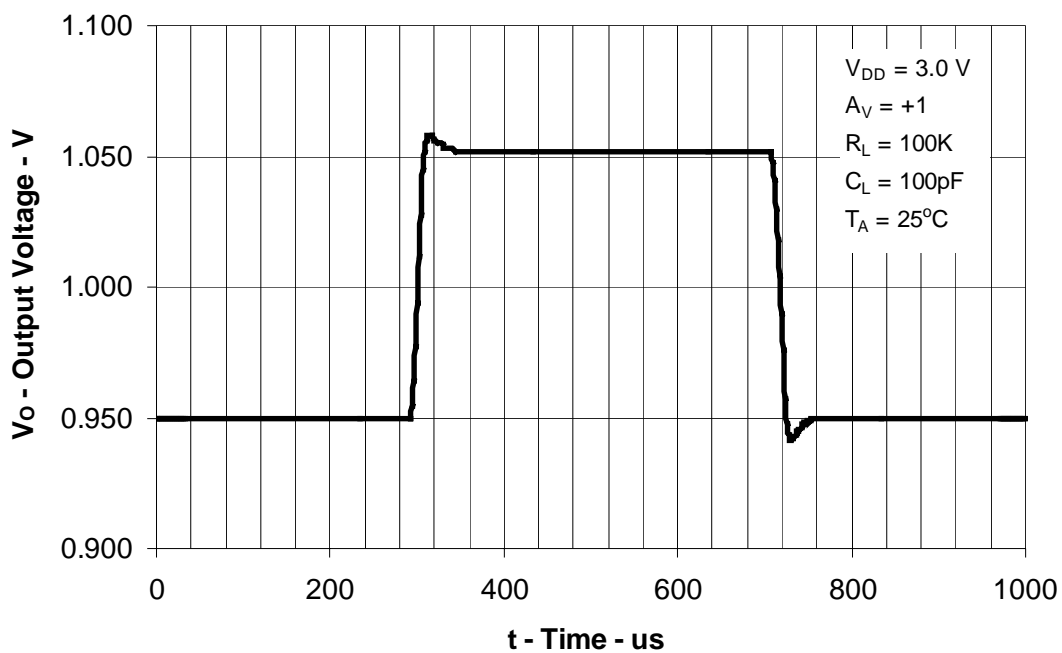

Figure 18.0

VOLTAGE-FOLLOWER LARGE-SIGNAL PULSE RESPONSE

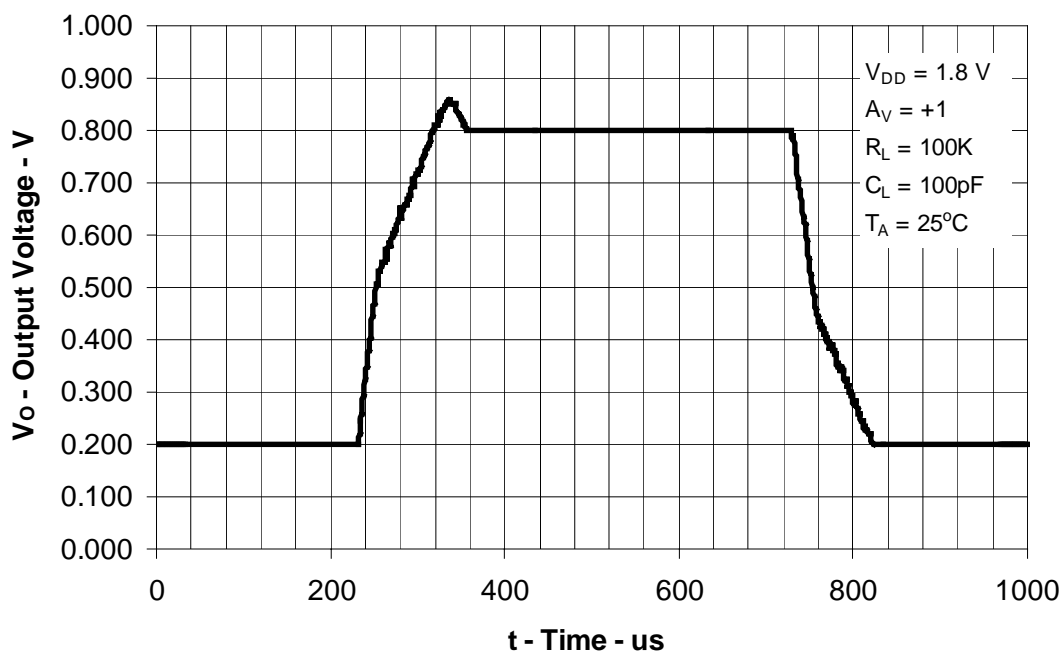

Figure 19.0

VOLTAGE-FOLLOWER LARGE-SIGNAL PULSE RESPONSE

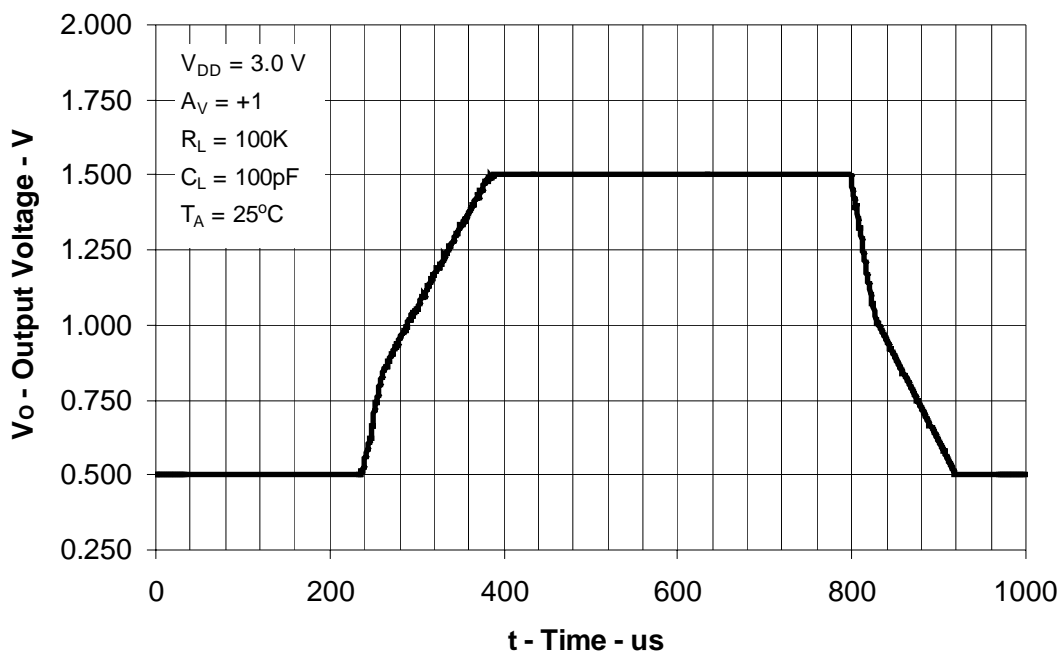
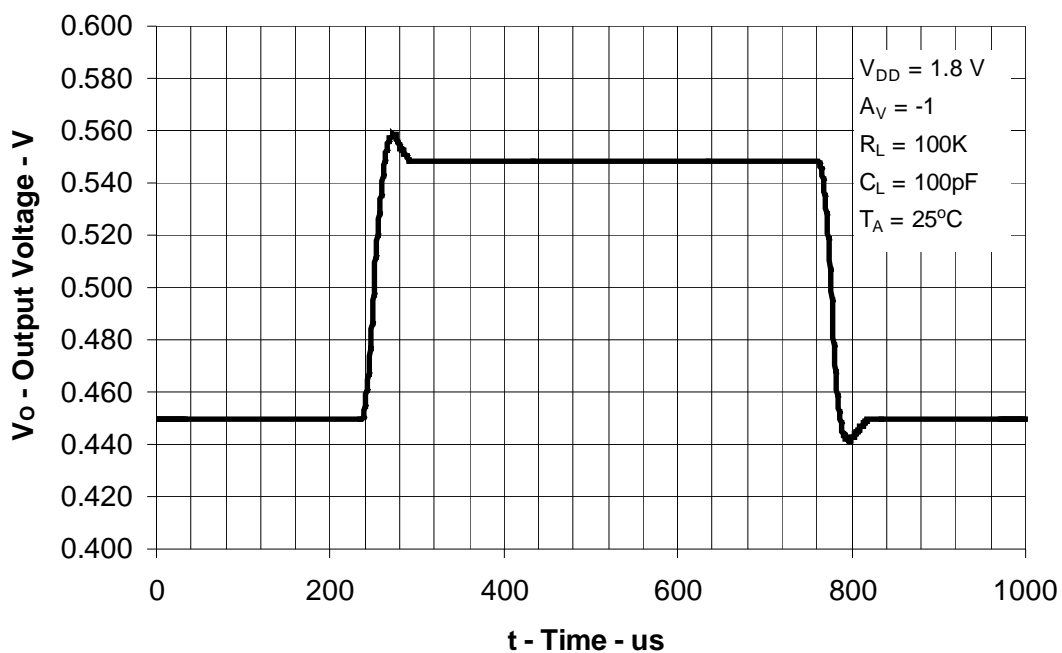
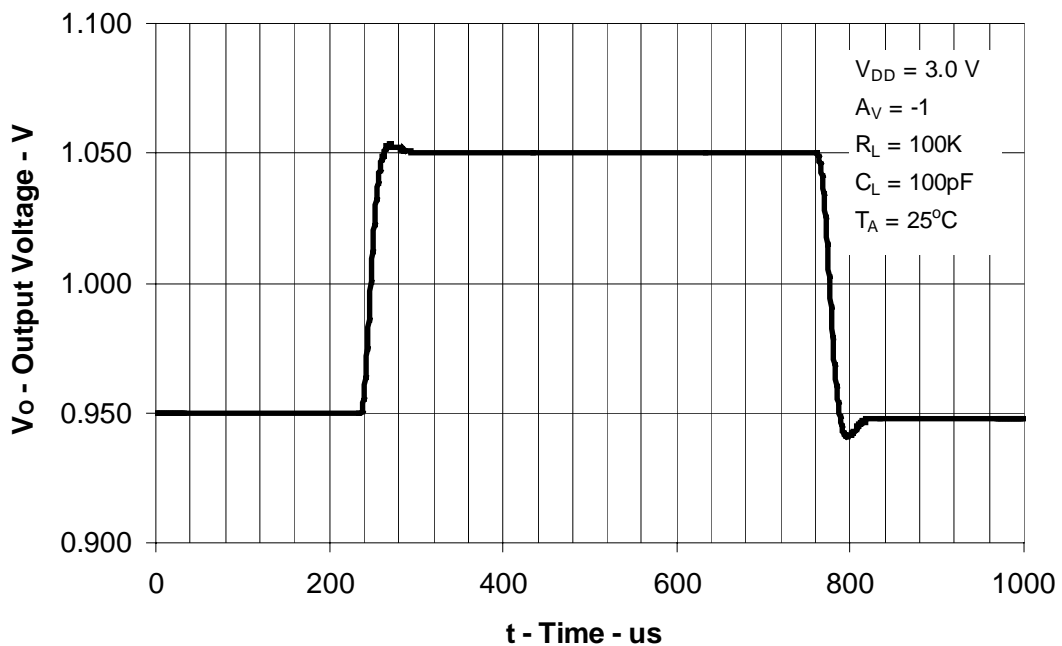
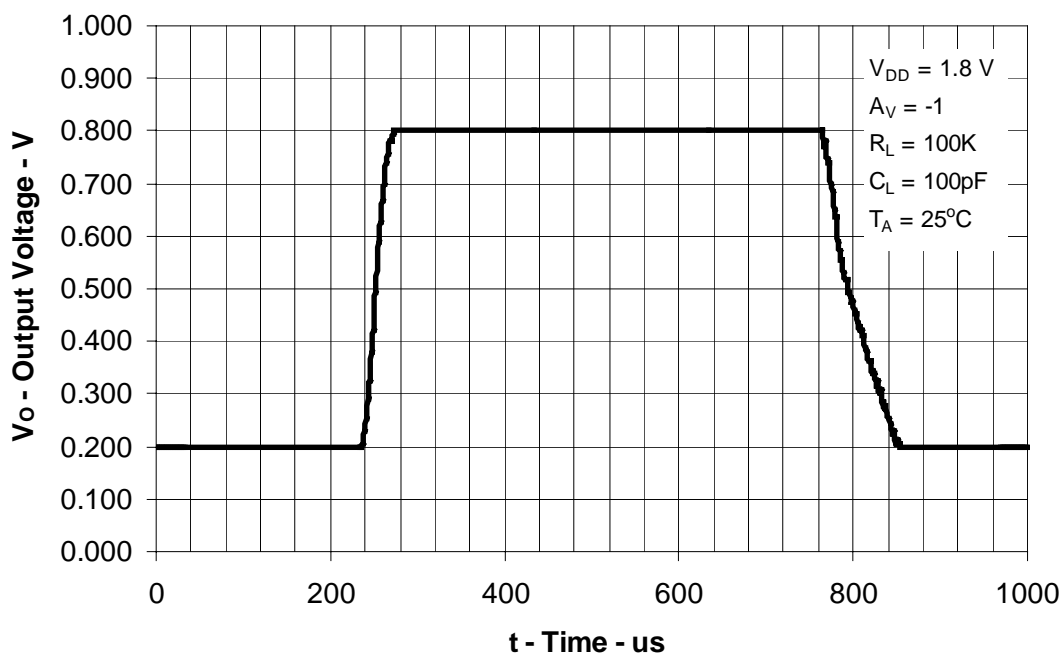
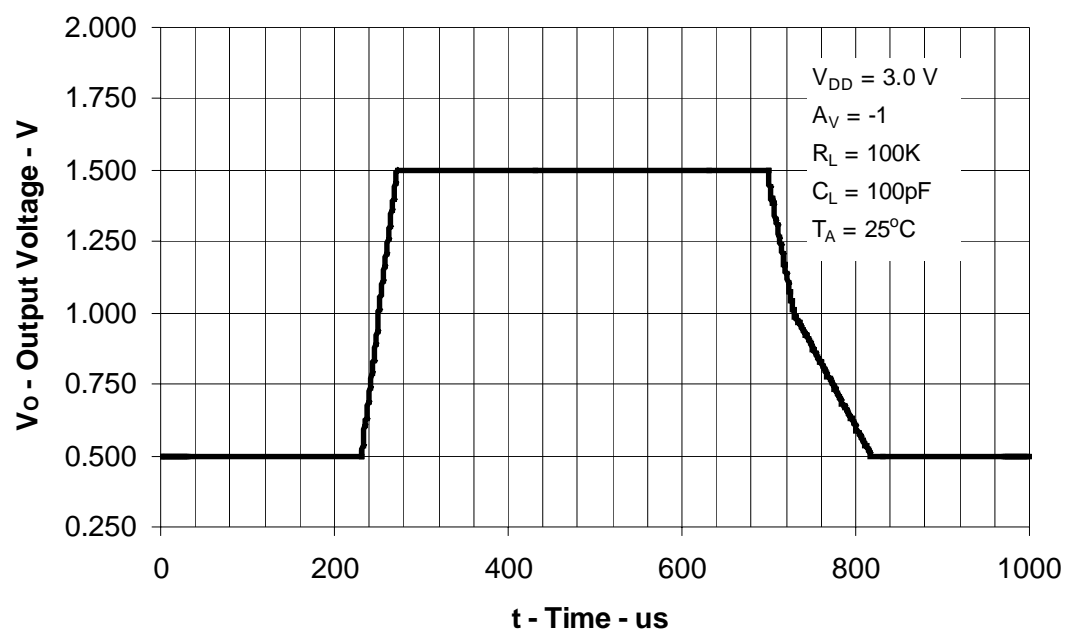

Figure 20.0

**INVERTING SMALL-SIGNAL
PULSE RESPONSE****Figure 21.0****INVERTING SMALL-SIGNAL
PULSE RESPONSE****Figure 22.0**

**INVERTING LARGE-SIGNAL
PULSE RESPONSE****Figure 23.0****INVERTING LARGE-SIGNAL
PULSE RESPONSE****Figure 24.0**

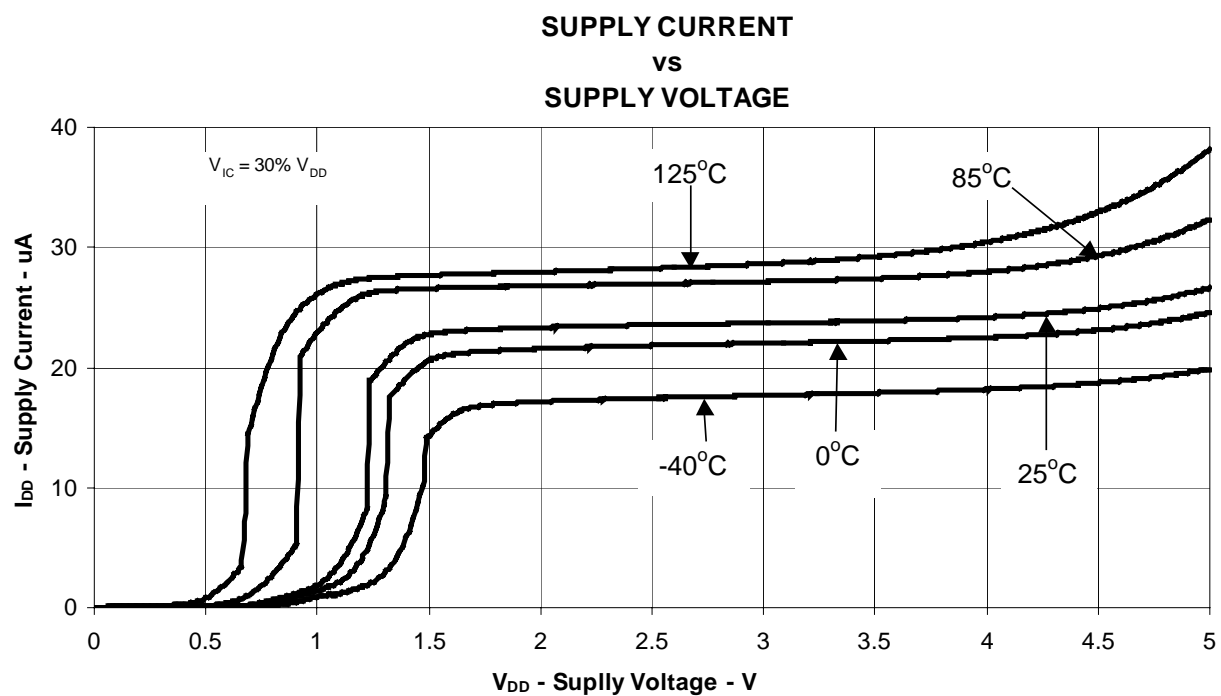

Figure 25.0

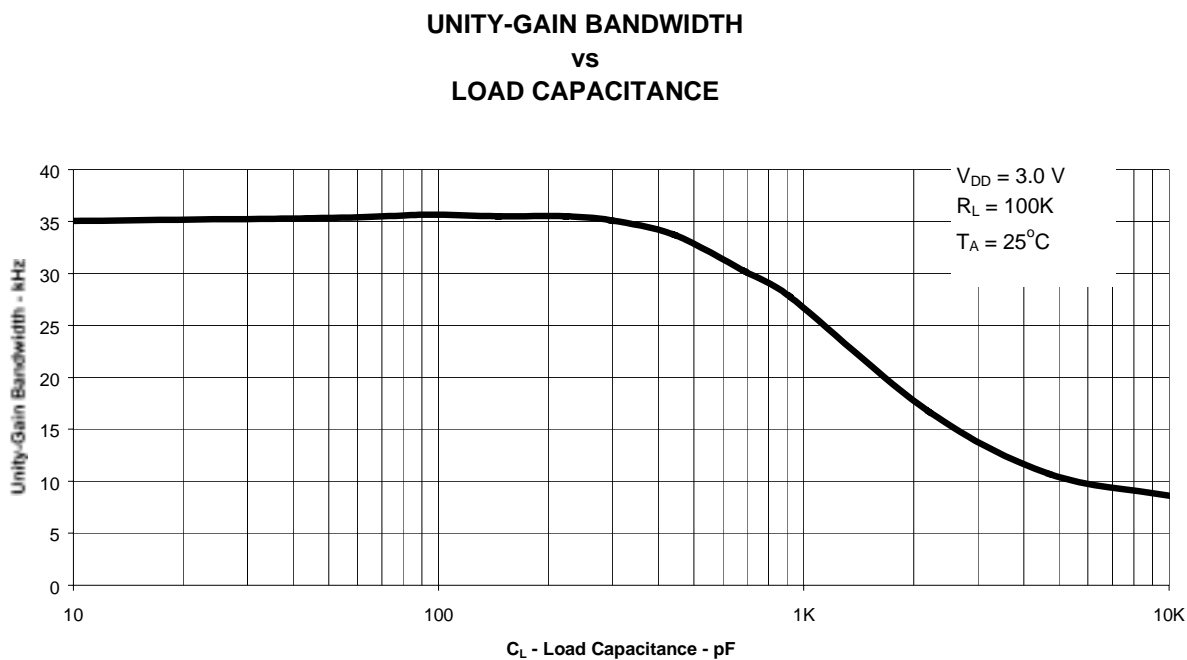

Figure 26.0

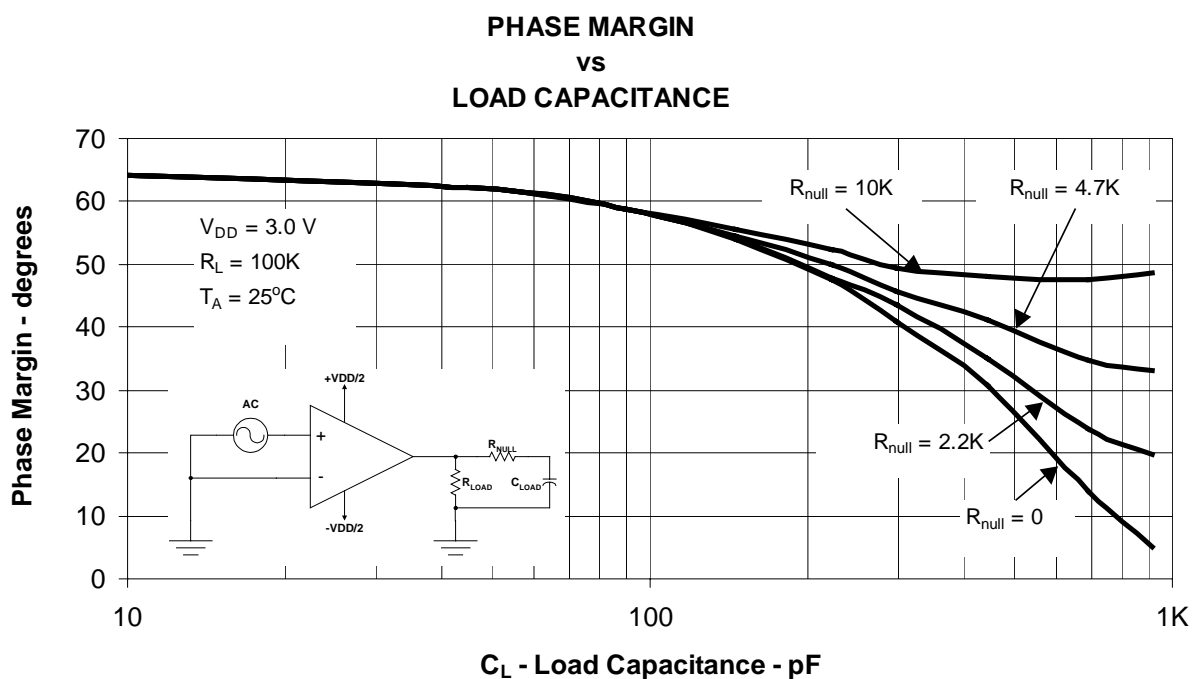

Figure 27.0

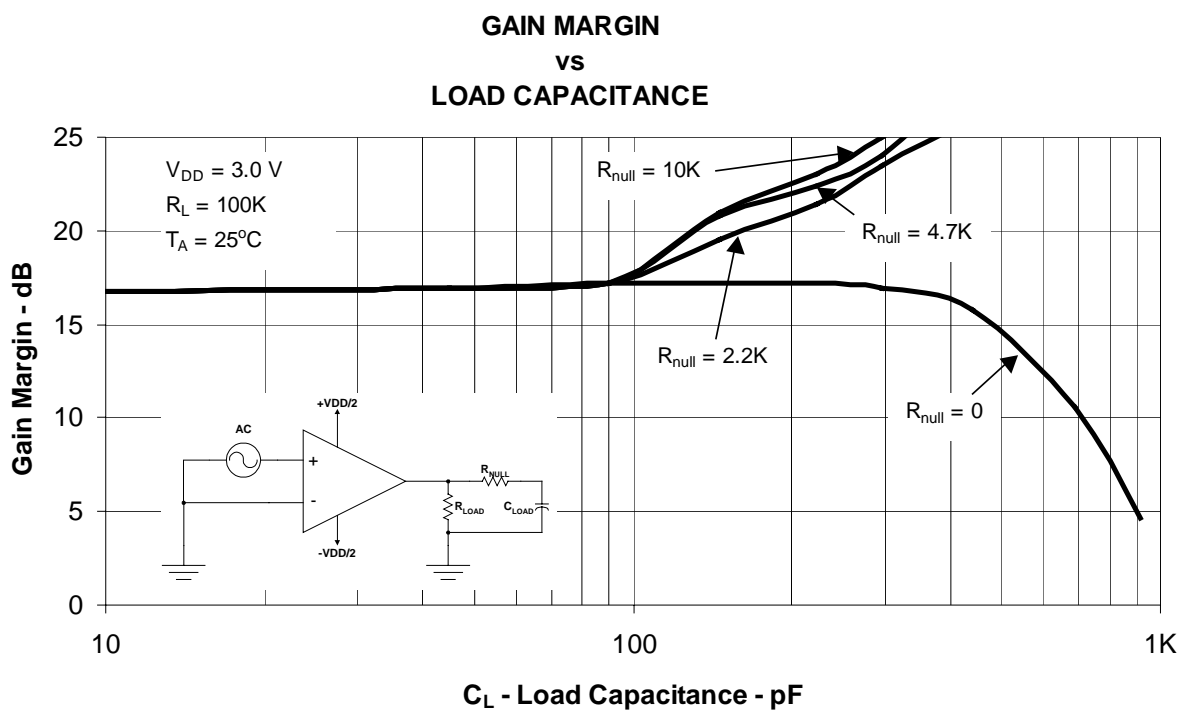

Figure 28.0