

Zener Diodes

Features

- Plastic package has Underwriters Laboratory Flammability Classification 94 V-0
- For surface mounted applications
- Glass passivated chip junction
- Low zener impedance
- Low regulation factor
- High temperature soldering guaranteed: 250 °C/ 10 seconds at terminals

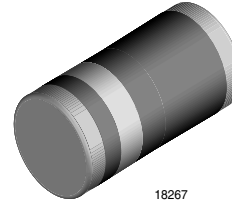

Mechanical Data

Case: MELF Plastic molded plastic over glass passivated junction

Terminals: Solder plated, solderable per MIL-STD-750, Method 2026

Polarity: Red band denotes Zener diode and positive end (cathode)

Mounting Position: Any

Weight: 0.0046oz., 116 mg

Packaging codes/options:

26 / 5 k per 13 " Reel (12 mm tape), 60 k/box

46 / 1.5 k per 7 " Reel (12 mm tape), 30 k/box

Absolute Maximum Ratings

T_{amb} = 25 °C, unless otherwise specified

Parameter	Test condition	Symbol	Value	Unit
Zener current (see Table "Characteristics")				
Power dissipation		P _{tot}	1.0 ³⁾	W

Thermal Characteristics

T_{amb} = 25 °C, unless otherwise specified

Parameter	Test condition	Symbol	Value	Unit
Thermal resistance junction to ambient air		R _{thJA}	170	°C/W
Junction temperature		T _j	150	°C
Storage temperature		T _s	- 65 to + 150	°C

Electrical Characteristics

Partnumber	Nominal Zener Voltage ¹⁾	Test Current	Maximum Dynamic Impedance			Maximum DC Reverse Leakage Current		Maximum Zener Current ⁽²⁾	Maximum Forward Voltage
	$V_Z @ I_{ZT}$	I_{ZT1}	$Z_{ZT} @ I_{ZT}$	$Z_{ZK} @ I_{ZK}$	I_{ZK}	I_R	V_R	I_{ZM}	$V_F @ 200 \text{ mA}$
	V	mA	Ω	Ω	mA	μA	V	mA_{pk}	V
GLL4735	6.2	41	2	700	1	50	3	730	1.2
GLL4736	6.8	37	3.5	700	1	10	4	660	1.2
GLL4737	7.5	34	4	700	0.5	10	5	605	1.2
GLL4738	8.2	31	4.5	700	0.5	10	6	550	1.2
GLL4739	9.1	28	5	700	0.5	10	7	500	1.2
GLL4740	10	25	7	700	0.25	10	7.6	454	1.2
GLL4741	11	23	8	700	0.25	5	8.4	414	1.2
GLL4742	12	21	9	700	0.25	5	9.1	380	1.2
GLL4743	13	19	10	700	0.25	5	9.9	344	1.2
GLL4744	15	17	14	700	0.25	5	11.4	305	1.2
GLL4745	16	15.5	16	700	0.25	5	12.2	285	1.2
GLL4746	18	14	20	750	0.25	5	13.7	250	1.2
GLL4747	20	12.5	22	750	0.25	5	15.2	225	1.2
GLL4748	22	11.5	23	750	0.25	5	16.7	205	1.2
GLL4749	24	10.5	25	750	0.25	5	18.2	190	1.2
GLL4750	27	9.5	35	750	0.25	5	20.6	170	1.2
GLL4751	30	8.5	40	1000	0.25	5	22.8	150	1.2
GLL4752	33	7.5	45	1000	0.25	5	25.1	135	1.2
GLL4753	36	7	50	1000	0.25	5	27.4	125	1.2
GLL4754	39	6.5	60	1000	0.25	5	29.7	115	1.2
GLL4755	43	6	70	1500	0.25	5	32.7	110	1.2
GLL4756	47	5.5	80	1500	0.25	5	35.8	95	1.2
GLL4757	51	5	95	1500	0.25	5	38.8	90	1.2
GLL4758	56	4.5	110	2000	0.25	5	42.6	80	1.2
GLL4759	62	4	125	2000	0.25	5	47.1	70	1.2
GLL4760	68	3.7	150	2000	0.25	5	51.7	65	1.2
GLL4761	75	3.3	175	2000	0.25	5	56	60	1.2
GLL4762	82	3	200	3000	0.25	5	62.2	55	1.2
GLL4763	91	2.8	250	3000	0.25	5	69.2	50	1.2

⁽¹⁾ Standard voltage tolerance is $\pm 10\%$, Suffix A = $\pm 5\%$

⁽²⁾ Surge current is a non-repetitive, 8.3 ms pulse width square wave or equivalent sine-wave superimposed on I_{ZT} per JEDEC Method

⁽³⁾ Maximum steady state power dissipation is 1.0 watt at $T_T = 75^\circ\text{C}$

Typical Characteristics ($T_{amb} = 25\text{ }^{\circ}\text{C}$ unless otherwise specified)

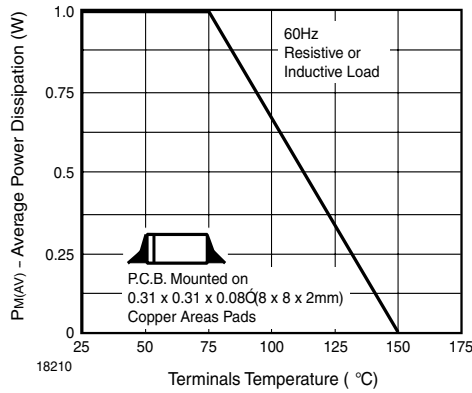

Figure 1. Maximum Continuous Power Dissipation

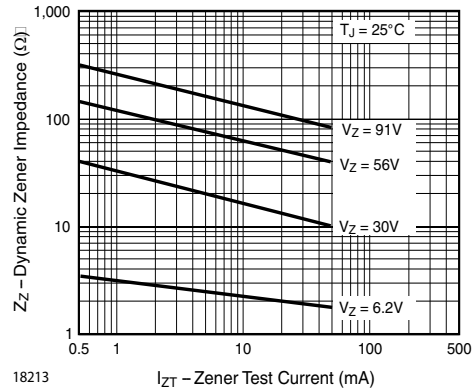

Figure 4. Typical Zener Impedance

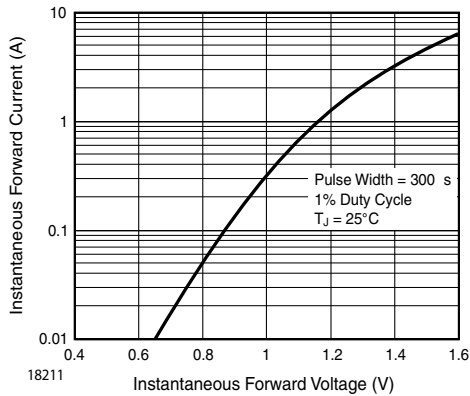

Figure 2. Typical Instantaneous Forward Characteristics for GLL4763

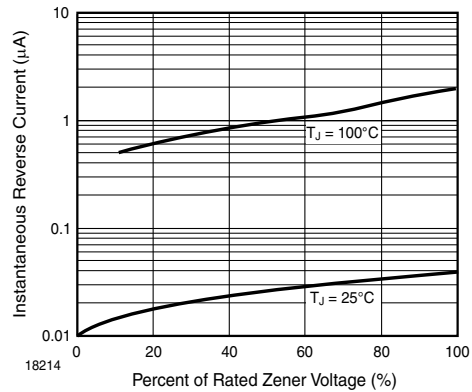

Figure 5. Typical Reverse Characteristics

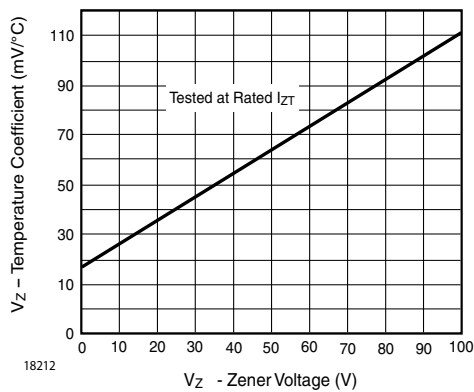

Figure 3. Typical Temperature Coefficients

GLL4735 to GLL4763A



Vishay Semiconductors

Package Dimensions in Inches (mm)

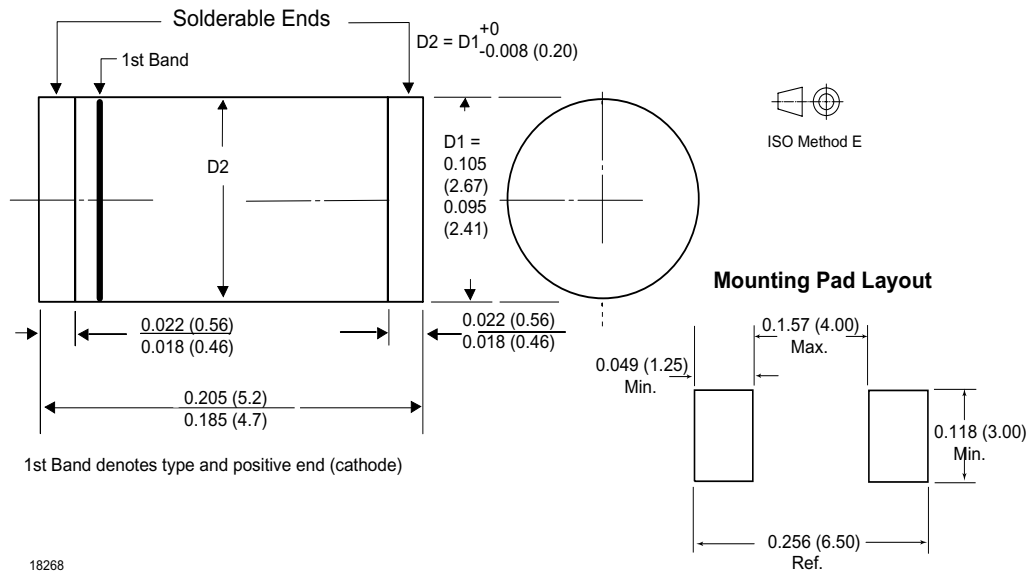



Ozone Depleting Substances Policy Statement

It is the policy of Vishay Semiconductor GmbH to

1. Meet all present and future national and international statutory requirements.
2. Regularly and continuously improve the performance of our products, processes, distribution and operating systems with respect to their impact on the health and safety of our employees and the public, as well as their impact on the environment.

It is particular concern to control or eliminate releases of those substances into the atmosphere which are known as ozone depleting substances (ODSs).

The Montreal Protocol (1987) and its London Amendments (1990) intend to severely restrict the use of ODSs and forbid their use within the next ten years. Various national and international initiatives are pressing for an earlier ban on these substances.

Vishay Semiconductor GmbH has been able to use its policy of continuous improvements to eliminate the use of ODSs listed in the following documents.

1. Annex A, B and list of transitional substances of the Montreal Protocol and the London Amendments respectively
2. Class I and II ozone depleting substances in the Clean Air Act Amendments of 1990 by the Environmental Protection Agency (EPA) in the USA
3. Council Decision 88/540/EEC and 91/690/EEC Annex A, B and C (transitional substances) respectively.

Vishay Semiconductor GmbH can certify that our semiconductors are not manufactured with ozone depleting substances and do not contain such substances.

We reserve the right to make changes to improve technical design and may do so without further notice.

Parameters can vary in different applications. All operating parameters must be validated for each customer application by the customer. Should the buyer use Vishay Semiconductors products for any unintended or unauthorized application, the buyer shall indemnify Vishay Semiconductors against all claims, costs, damages, and expenses, arising out of, directly or indirectly, any claim of personal damage, injury or death associated with such unintended or unauthorized use.

Vishay Semiconductor GmbH, P.O.B. 3535, D-74025 Heilbronn, Germany
Telephone: 49 (0)7131 67 2831, Fax number: 49 (0)7131 67 2423



Notice

Specifications of the products displayed herein are subject to change without notice. Vishay Intertechnology, Inc., or anyone on its behalf, assumes no responsibility or liability for any errors or inaccuracies.

Information contained herein is intended to provide a product description only. No license, express or implied, by estoppel or otherwise, to any intellectual property rights is granted by this document. Except as provided in Vishay's terms and conditions of sale for such products, Vishay assumes no liability whatsoever, and disclaims any express or implied warranty, relating to sale and/or use of Vishay products including liability or warranties relating to fitness for a particular purpose, merchantability, or infringement of any patent, copyright, or other intellectual property right.

The products shown herein are not designed for use in medical, life-saving, or life-sustaining applications. Customers using or selling these products for use in such applications do so at their own risk and agree to fully indemnify Vishay for any damages resulting from such improper use or sale.