

Powerex, Inc., 200 Hillis Street, Youngwood, Pennsylvania 15697-1800 (412) 925-7272
 Powerex, Europe, S.A. 428 Avenue G. Durand, BP107, 72003 Le Mans, France (43) 41.14.14

Phase Control SCR
 350 Amperes Average
 4500 Volts

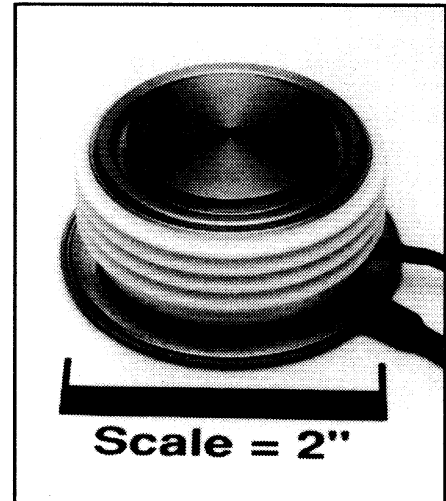
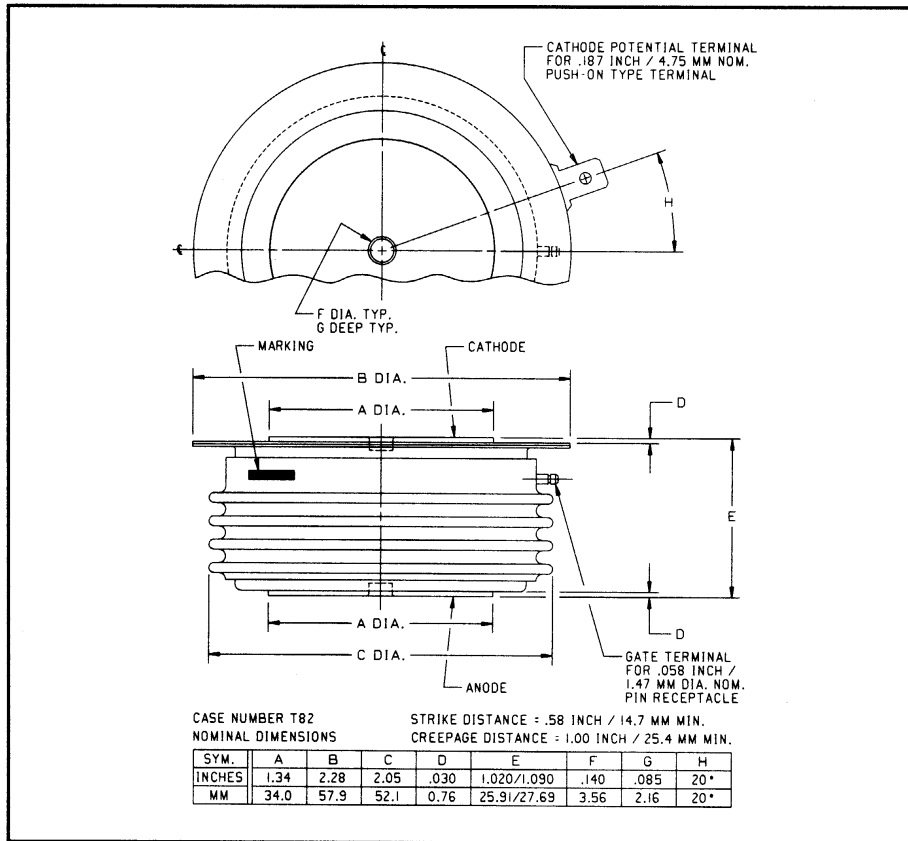

T8K7 350A Phase Control SCR
 350 Amperes Average, 4500 Volts

T8K7 350A (Outline Drawing)

Description:

Powerex Silicon Controlled Rectifiers (SCR) are designed for phase control applications. These are all-diffused, Press-Pak, hermetic Pow-R-Disc devices employing the field proven amplifying gate.

Features:

- Low On-State Voltage
- High di/dt Capability
- High dv/dt Capability
- Hermetic Packaging
- Excellent Surge and I²t Ratings

Applications:

- Power Supplies
- Motor Control

Ordering Information:

Select the complete 12 digit part number you desire from the table below.

Type	Voltage	Current	Turn-off	Gate Current	Lead Code
	V _{DRM} /V _{RRM} (Volts)	I _{T(av)} (A)	t _q (µsec)	I _{GT} (mA)	
T8K7	36 40 45	35	0	3	DH
	3600V 4000V 4500V	350A	250µsec (Typical)	200mA	12"

T8K7 350A

Phase Control SCR

350 Amperes Average, 4500 Volts

Absolute Maximum Ratings

Characteristics	Symbol	T8K7 350A	Units
Non-repetitive Transient Peak Reverse Voltage	V_{RSM}	$V_{RRM} + 100V$	Volts
RMS On-state Current, $T_C = 76^\circ C$	$I_{T(rms)}$	550	Amperes
Average Current 180° Sine Wave, $T_C = 76^\circ C$	$I_{T(av)}$	350	Amperes
RMS On-state Current, $T_C = 55^\circ C$	$I_{T(rms)}$	710	Amperes
Average Current 180° Sine Wave, $T_C = 55^\circ C$	$I_{T(av)}$	450	Amperes
Peak One Cycle Surge On-state Current (Non-repetitive) 60Hz	I_{tsm}	5500	Amperes
Peak One Cycle Surge On-state Current (Non-repetitive) 50Hz	I_{tsm}	5060	Amperes
Critical Rate-of-rise of On-state Current (Non-repetitive)	di/dt	500	A/ μ sec
Critical Rate-of-rise of On-state Current (Repetitive)	di/dt	150	A/ μ sec
I^2t (for Fusing) for One Cycle, 60Hz	I^2t	100,000	A ² sec
Peak Gate Power Dissipation	P_{GM}	50	Watts
Average Gate Power Dissipation	$P_{G(av)}$	5	Watts
Operating Temperature	T_j	-40 to +125°C	°C
Storage Temperature	T_{stg}	-40 to +150°C	°C
Approximate Weight		8	oz.
		227	g
Mounting Force		3000 to 3500	lb.
		1360 to 1590	kg.

T8K7 350A
Phase Control SCR
 350 Amperes Average, 4500 Volts

Electrical Characteristics, $T_j = 25^\circ\text{C}$ Unless Otherwise Specified

Characteristics	Symbol	Test Conditions	Min.	Typ.	Max.	Units
Repetitive Peak Reverse Leakage Current	I_{RRM}	$T_j = 125^\circ\text{C}, V_R = V_{RRM}$			75	mA
Repetitive Peak Forward Leakage Current	I_{DRM}	$T_j = 125^\circ\text{C}, V_D = V_{DRM}$			75	mA
Peak On-state Voltage	V_{TM}	$I_{TM} = 1000\text{A Peak}$ $t_p = 8\text{msec}$			3.5	Volts
Threshold Voltage, Low-level	$V_{(TO)1}$	$T_j = 125^\circ\text{C}, I = 15\%, I_{T(av)}$ to $\pi I_{T(av)}$			1.5618	Volts
Slope Resistance, Low-level	r_{T1}				2.1412	m Ω
Threshold Voltage, High-level	$V_{(TO)2}$	$T_j = 125^\circ\text{C}, I = \pi I_{T(av)}$ to I_{TSM}			2.7113	Volts
Slope Resistance, High-level	r_{T2}				0.96929	m Ω
V_{TM} Coefficients, Low-level		$T_j = 125^\circ\text{C}, I = 15\% I_{T(av)}$ to $\pi I_{T(av)}$			$A_1 = 1.1505$ $B_1 = -0.14678$ $C_1 = -9.586\text{E-}04$ $D_1 = 0.13681$	
V_{TM} Coefficients, High-level		$T_j = 125^\circ\text{C}, I = \pi I_{T(av)}$ to I_{TSM}			$A_2 = -13.457$ $B_2 = 3.0936$ $C_2 = 1.627\text{E-}03$ $D_2 = -0.19076$	
Typical Delay Time	t_d	$V_D = 0.5V_{DRM}$		2.0		μsec
Typical Turn-off Time	t_q	$V_R = 100\text{V},$ $di_R/dt = 5\text{A}/\mu\text{sec}$ Reapplied $dv/dt = 20\text{V}/\mu\text{sec}$ Linear to 50% V_{DRM}		250		μsec
Minimum Critical dv/dt - Linear to V_{DRM}	dv/dt	$T_j = 125^\circ\text{C}, V_D = 0.67V_{DRM}$	500	1000		$\text{V}/\mu\text{sec}$
Gate Trigger Current	I_{GT}	$T_j = 25^\circ\text{C}, V_D = 12\text{V}$			200	mA
Gate Trigger Voltage	V_{GT}	$T_j = 25^\circ\text{C}, V_D = 12\text{V}$			3.0	Volts
Peak Reverse Gate Voltage	V_{GRM}				4.0	Volts

Thermal Characteristics

Maximum Thermal Resistance, Double Sided Cooling

Junction-to-Case	$R_{\theta(j-c)}$				0.040	$^\circ\text{C}/\text{W}$
Case-to-Sink	$R_{\theta(c-s)}$				0.020	$^\circ\text{C}/\text{W}$

Powerex, Inc., 200 Hillis Street, Youngwood, Pennsylvania 15697-1800 (412) 925-7272
 Powerex, Europe, S.A. 428 Avenue G. Durand, BP107, 72003 Le Mans, France (43) 41.14.14

T8K7 350A
Phase Control SCR
 350 Amperes Average, 4500 Volts

Maximum On-State Forward Voltage Drop
 ($T_J = 125^\circ\text{C}$)

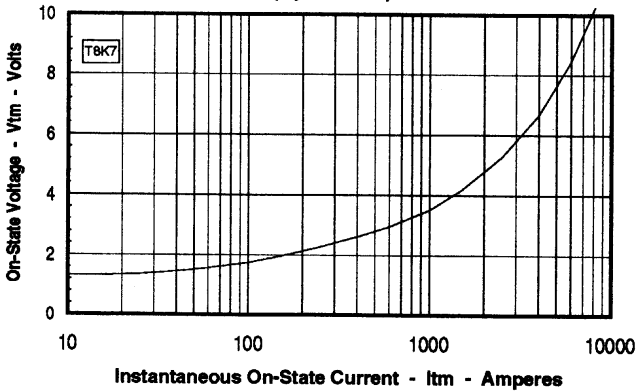

Maximum Transient Thermal Impedance
 (Junction to Case)

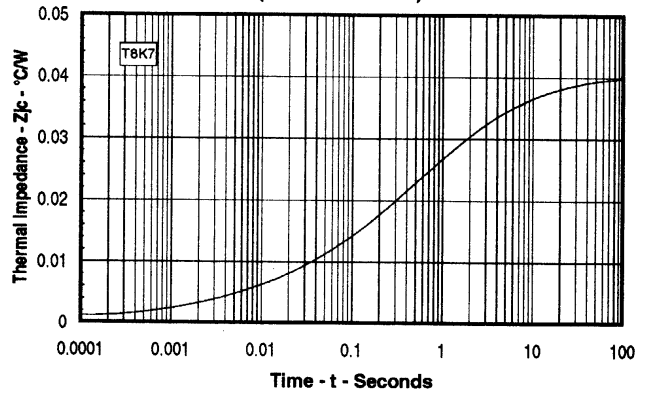

Maximum On-State Power Dissipation
 (Sinusoidal Waveform)

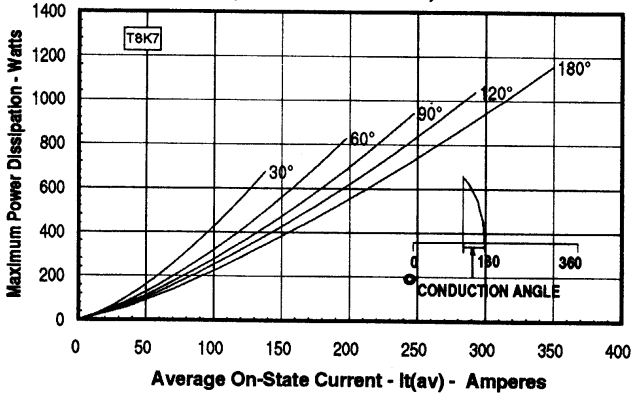

Maximum Allowable Case Temperature
 (Rectangular Waveform)

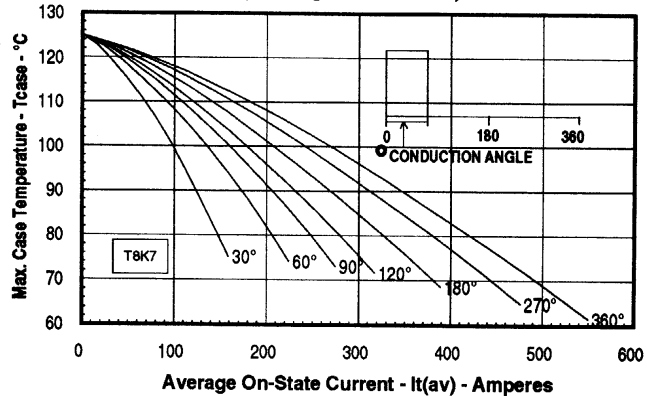

Maximum On-State Power Dissipation
 (Rectangular Waveform)

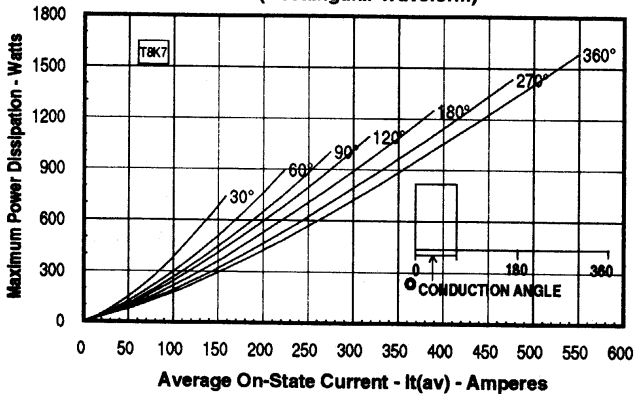

Maximum Allowable Case Temperature
 (Rectangular Waveform)

