

# NID9N05CL

## Power MOSFET 9 Amps, 52 Volts N-Channel, Logic Level, Clamped MOSFET w/ ESD Protection in a DPAK Package

### Benefits

- High Energy Capability for Inductive Loads
- Low Switching Noise Generation

### Features

- Diode Clamp Between Gate and Source
- ESD Protection - HBM 5000 V
- Active Over-Voltage Gate to Drain Clamp
- Scalable to Lower or Higher  $R_{DS(on)}$
- Internal Series Gate Resistance

### Applications

- Automotive and Industrial Markets:  
Solenoid Drivers, Lamp Drivers, Small Motor Drivers

### MAXIMUM RATINGS ( $T_J = 25^\circ\text{C}$ unless otherwise noted)

Rating	Symbol	Value	Unit
Drain-to-Source Voltage Internally Clamped	$V_{DSS}$	52-59	Vdc
Gate-to-Source Voltage - Continuous	$V_{GS}$	$\pm 12$	Vdc
Drain Current - Continuous @ $T_A = 25^\circ\text{C}$ - Single Pulse ( $t_p = 10 \mu\text{s}$ )	$I_D$ $I_{DM}$	9.0 35	A
Total Power Dissipation @ $T_A = 25^\circ\text{C}$	$P_D$	28.8	W
Operating and Storage Temperature Range	$T_J, T_{stg}$	-55 to 175	$^\circ\text{C}$
Single Pulse Drain-to-Source Avalanche Energy - Starting $T_J = 125^\circ\text{C}$ ( $V_{DD} = 50 \text{ V}$ , $I_{D(pk)} = 1.5 \text{ A}$ , $V_{GS} = 10 \text{ V}$ , $R_G = 25 \Omega$ )	$E_{AS}$	160	mJ
Thermal Resistance - Junction-to-Case - Junction-to-Ambient (Note 1) - Junction-to-Ambient (Note 2)	$R_{\theta JC}$ $R_{\theta JA}$ $R_{\theta JA}$	5.2 72 100	$^\circ\text{C/W}$
Maximum Lead Temperature for Soldering Purposes, 1/8" from Case for 10 Sec.	$T_L$	260	$^\circ\text{C}$

1. When surface mounted to an FR4 board using 1" pad size, (Cu area 1.127 in<sup>2</sup>)
2. When surface mounted to an FR4 board using minimum recommended pad size, (Cu area 0.412 in<sup>2</sup>)



ON Semiconductor®

<http://onsemi.com>

**9 AMPERES**  
**52 V CLAMPED**  
 **$R_{DS(on)} = 90 \text{ m}\Omega$  (Typ.)**

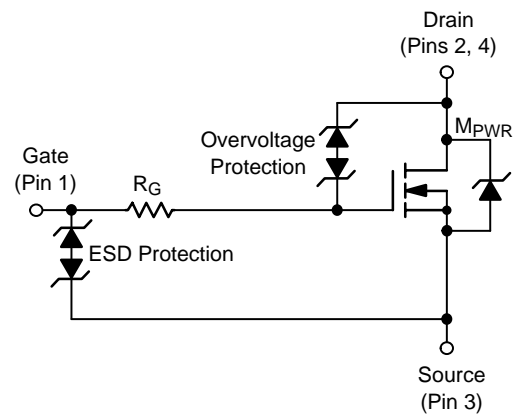

**DPAK  
CASE 369A  
STYLE 2**

### MARKING DIAGRAM

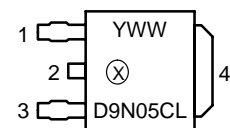

D9N05CL = Device Code  
Y = Year  
WW = Work Week

1 = Gate  
2 = Drain  
3 = Source  
4 = Drain

### ORDERING INFORMATION

Device	Package	Shipping
NID9N05CLT4	DPAK	2500/Tape & Reel
NID9N05CL	DPAK	75 Units/Rail

# NID9N05CL

## MOSFET ELECTRICAL CHARACTERISTICS ( $T_J = 25^\circ\text{C}$ unless otherwise noted)

Characteristic	Symbol	Min	Typ	Max	Unit
----------------	--------	-----	-----	-----	------

### OFF CHARACTERISTICS

Drain-to-Source Breakdown Voltage (Note 3) ( $V_{GS} = 0 \text{ Vdc}$ , $I_D = 1.0 \text{ mAdc}$ ) Temperature Coefficient (Negative)	$V_{(BR)DSS}$	52 -	55 -10	59 -	Vdc mV/ $^\circ\text{C}$
Zero Gate Voltage Drain Current ( $V_{DS} = 40 \text{ Vdc}$ , $V_{GS} = 0 \text{ Vdc}$ ) ( $V_{DS} = 40 \text{ Vdc}$ , $V_{GS} = 0 \text{ Vdc}$ , $T_J = 125^\circ\text{C}$ )	$I_{DSS}$	- -	- -	10 25	$\mu\text{Adc}$
Gate-Body Leakage Current ( $V_{GS} = \pm 8 \text{ Vdc}$ , $V_{DS} = 0 \text{ Vdc}$ ) ( $V_{GS} = \pm 14 \text{ Vdc}$ , $V_{DS} = 0 \text{ Vdc}$ )	$I_{GSS}$	- -	- $\pm 22$	$\pm 10$ -	$\mu\text{Adc}$

### ON CHARACTERISTICS (Note 3)

Gate Threshold Voltage (Note 3) ( $V_{DS} = V_{GS}$ , $I_D = 100 \mu\text{Adc}$ ) Threshold Temperature Coefficient (Negative)	$V_{GS(th)}$	1.3 -	1.75 -4.5	2.5 -	Vdc mV/ $^\circ\text{C}$
Static Drain-to-Source On-Resistance (Note 3) ( $V_{GS} = 4.0 \text{ Vdc}$ , $I_D = 1.5 \text{ Adc}$ ) ( $V_{GS} = 3.5 \text{ Vdc}$ , $I_D = 0.6 \text{ Adc}$ ) ( $V_{GS} = 3.0 \text{ Vdc}$ , $I_D = 0.2 \text{ Adc}$ ) ( $V_{GS} = 12 \text{ Vdc}$ , $I_D = 9.0 \text{ Adc}$ ) ( $V_{GS} = 12 \text{ Vdc}$ , $I_D = 12 \text{ Adc}$ )	$R_{DS(on)}$	- - - 70 67	153 175 - 90 95	181 364 1210 - -	m $\Omega$
Forward Transconductance (Note 3) ( $V_{DS} = 15 \text{ Vdc}$ , $I_D = 9.0 \text{ Adc}$ )	$g_{FS}$	-	24	-	Mhos

### DYNAMIC CHARACTERISTICS

Input Capacitance	$(V_{DS} = 40 \text{ Vdc}, V_{GS} = 0 \text{ V}, f = 10 \text{ kHz})$	$C_{iss}$	-	155	250	pF
Output Capacitance		$C_{oss}$	-	60	100	
Transfer Capacitance		$C_{rss}$	-	25	40	
Input Capacitance	$(V_{DS} = 25 \text{ Vdc}, V_{GS} = 0 \text{ V}, f = 10 \text{ kHz})$	$C_{iss}$	-	175	-	pF
Output Capacitance		$C_{oss}$	-	70	-	
Transfer Capacitance		$C_{rss}$	-	30	-	

3. Pulse Test: Pulse Width  $\leq 300 \mu\text{s}$ , Duty Cycle  $\leq 2\%$ .
4. Switching characteristics are independent of operating junction temperatures.

# NID9N05CL

## MOSFET ELECTRICAL CHARACTERISTICS ( $T_J = 25^\circ\text{C}$ unless otherwise noted)

Characteristic	Symbol	Min	Typ	Max	Unit
<b>SWITCHING CHARACTERISTICS (Note 4)</b>					
Turn-On Delay Time	$t_{d(on)}$	-	130	200	ns
Rise Time	$t_r$	-	500	750	
Turn-Off Delay Time	$t_{d(off)}$	-	1300	2000	
Fall Time	$t_f$	-	1150	1850	
Turn-On Delay Time	$t_{d(on)}$	-	200	-	ns
Rise Time	$t_r$	-	500	-	
Turn-Off Delay Time	$t_{d(off)}$	-	2500	-	
Fall Time	$t_f$	-	1800	-	
Turn-On Delay Time	$t_{d(on)}$	-	120	-	ns
Rise Time	$t_r$	-	275	-	
Turn-Off Delay Time	$t_{d(off)}$	-	1600	-	
Fall Time	$t_f$	-	1100	-	
Gate Charge	$Q_T$	-	4.5	7.0	nC
	$Q_1$	-	1.2	-	
	$Q_2$	-	2.7	-	
Gate Charge	$Q_T$	-	3.6	-	nC
	$Q_1$	-	1.0	-	
	$Q_2$	-	2.0	-	

## SOURCE-DRAIN DIODE CHARACTERISTICS

Forward On-Voltage	( $I_S = 4.5 \text{ Adc}$ , $V_{GS} = 0 \text{ Vdc}$ ) (Note 3) ( $I_S = 4.0 \text{ Adc}$ , $V_{GS} = 0 \text{ Vdc}$ ) ( $I_S = 4.5 \text{ Adc}$ , $V_{GS} = 0 \text{ Vdc}$ , $T_J = 125^\circ\text{C}$ )	$V_{SD}$	- - -	0.86 0.845 0.725	1.2 - -	Vdc
Reverse Recovery Time	( $I_S = 4.5 \text{ Adc}$ , $V_{GS} = 0 \text{ Vdc}$ , $di_s/dt = 100 \text{ A}/\mu\text{s}$ ) (Note 3)	$t_{rr}$	-	700	-	ns
		$t_a$	-	200	-	
		$t_b$	-	500	-	
Reverse Recovery Stored Charge		$Q_{RR}$	-	6.5	-	$\mu\text{C}$

## ESD CHARACTERISTICS

Electro-Static Discharge Capability	Human Body Model (HBM)	ESD	5000	-	-	V
	Machine Model (MM)		500	-	-	

3. Pulse Test: Pulse Width  $\leq 300 \mu\text{s}$ , Duty Cycle  $\leq 2\%$ .
4. Switching characteristics are independent of operating junction temperatures.

# NID9N05CL

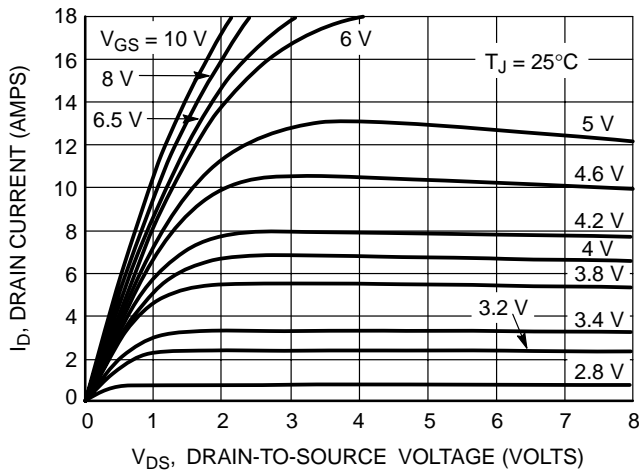

Figure 1. On-Region Characteristics

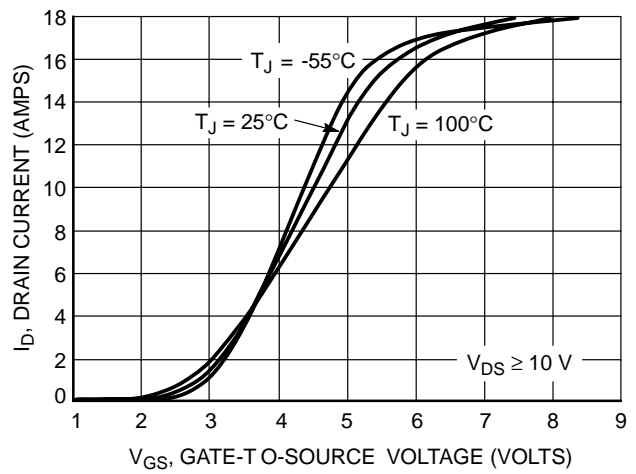

Figure 2. Transfer Characteristics

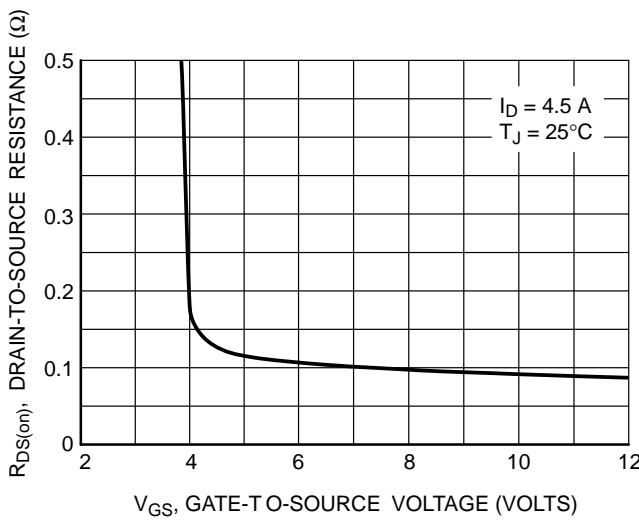

Figure 3. On-Resistance versus Gate-to-Source Voltage

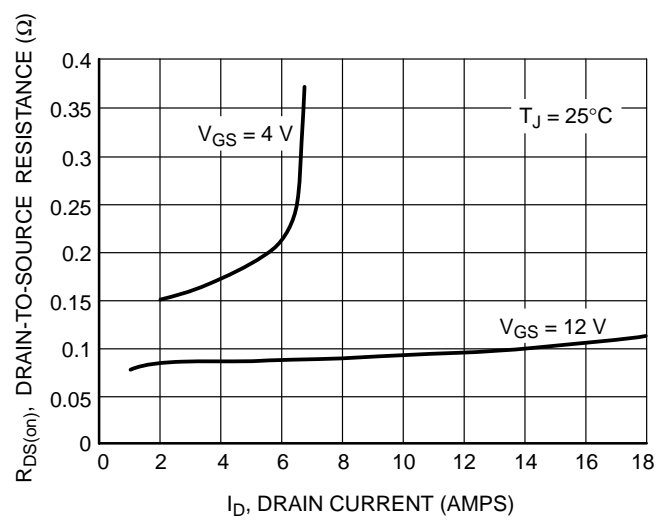

Figure 4. On-Resistance versus Drain Current and Gate Voltage

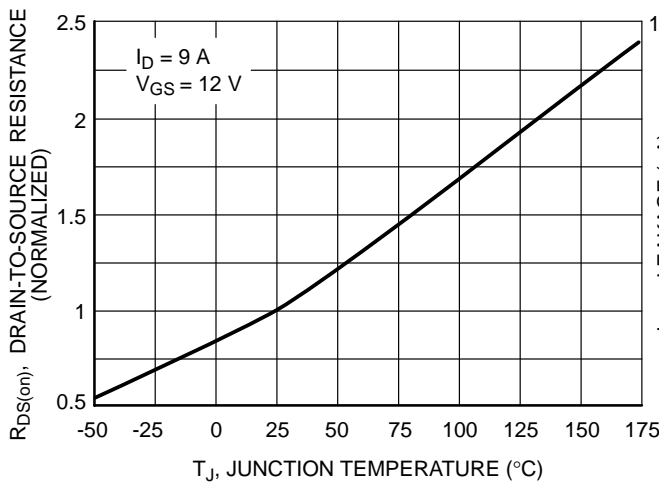

Figure 5. On-Resistance Variation with Temperature

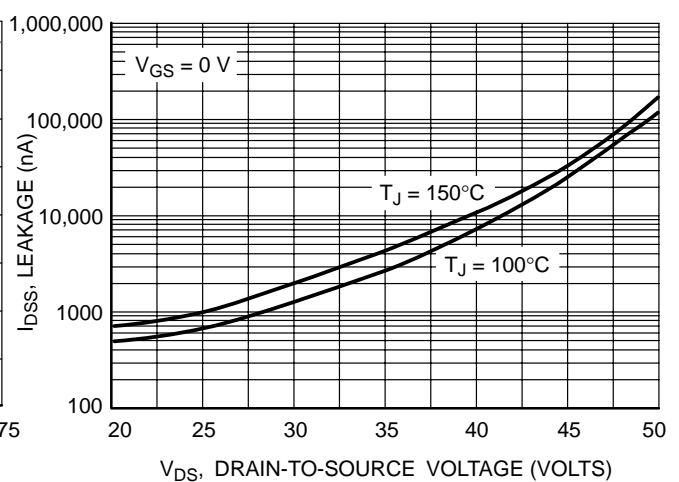

Figure 6. Drain-to-Source Leakage Current versus Voltage

# NID9N05CL

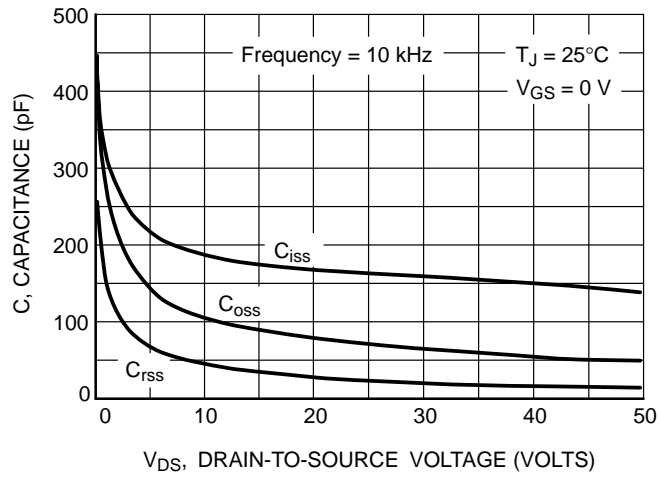

Figure 7. Capacitance Variation

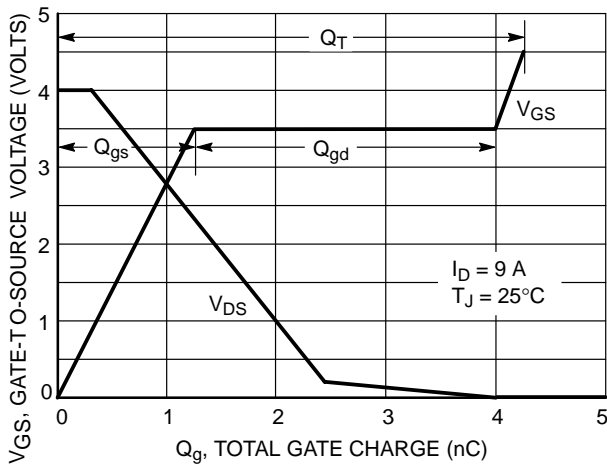

Figure 8. Gate-To-Source and Drain-To-Source Voltage versus Total Charge

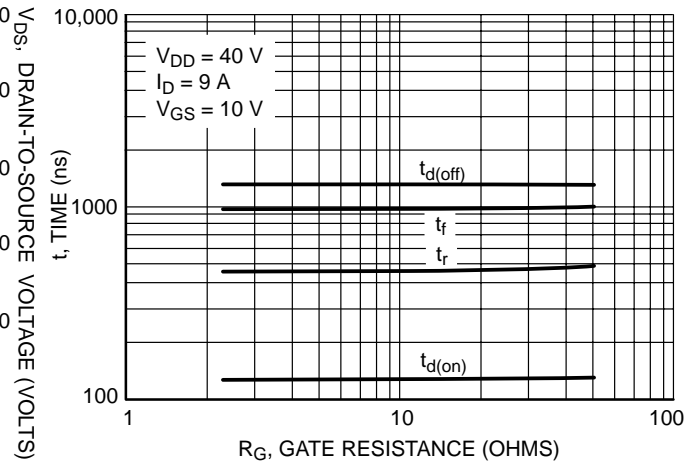

Figure 9. Resistive Switching Time Variation versus Gate Resistance

## DRAIN-TO-SOURCE DIODE CHARACTERISTICS

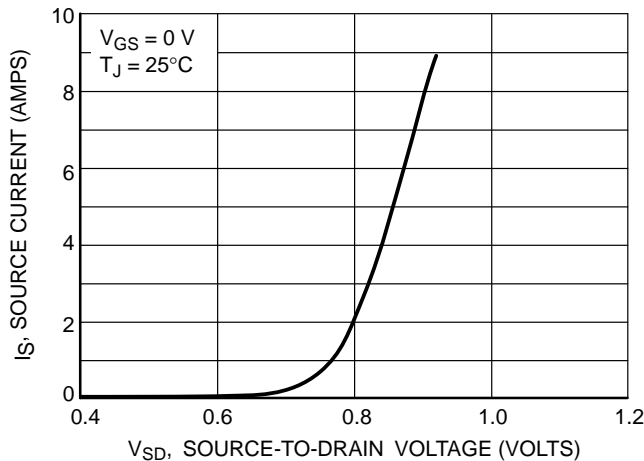

Figure 10. Diode Forward Voltage versus Current

## SAFE OPERATING AREA

The Forward Biased Safe Operating Area curves define the maximum simultaneous drain-to-source voltage and drain current that a transistor can handle safely when it is forward biased. Curves are based upon maximum peak junction temperature and a case temperature ( $T_C$ ) of 25°C. Peak repetitive pulsed power limits are determined by using the thermal response data in conjunction with the procedures discussed in AN569, "Transient Thermal Resistance - General Data and Its Use."

Switching between the off-state and the on-state may traverse any load line provided neither rated peak current ( $I_{DM}$ ) nor rated voltage ( $V_{DSS}$ ) is exceeded and the transition time ( $t_r, t_f$ ) do not exceed 10  $\mu$ s. In addition the total power averaged over a complete switching cycle must not exceed  $(T_{J(MAX)} - T_C)/(R_{\theta JC})$ .

A Power MOSFET designated E-FET can be safely used in switching circuits with unclamped inductive loads. For

reliable operation, the stored energy from circuit inductance dissipated in the transistor while in avalanche must be less than the rated limit and adjusted for operating conditions differing from those specified. Although industry practice is to rate in terms of energy, avalanche energy capability is not a constant. The energy rating decreases non-linearly with an increase of peak current in avalanche and peak junction temperature.

Although many E-FETs can withstand the stress of drain-to-source avalanche at currents up to rated pulsed current ( $I_{DM}$ ), the energy rating is specified at rated continuous current ( $I_D$ ), in accordance with industry custom. The energy rating must be derated for temperature as shown in the accompanying graph (Figure 12). Maximum energy at currents below rated continuous  $I_D$  can safely be assumed to equal the values indicated.

# NID9N05CL

## SAFE OPERATING AREA

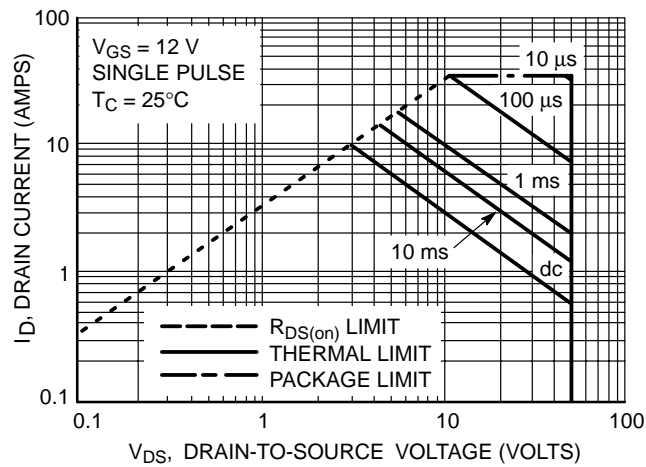

Figure 11. Maximum Rated Forward Biased Safe Operating Area

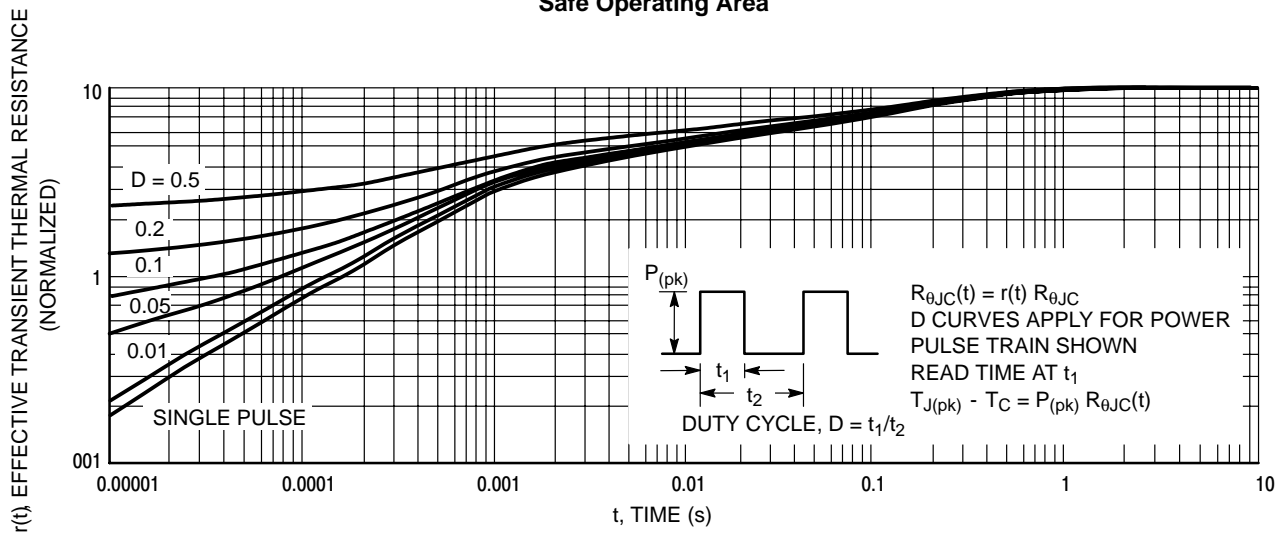
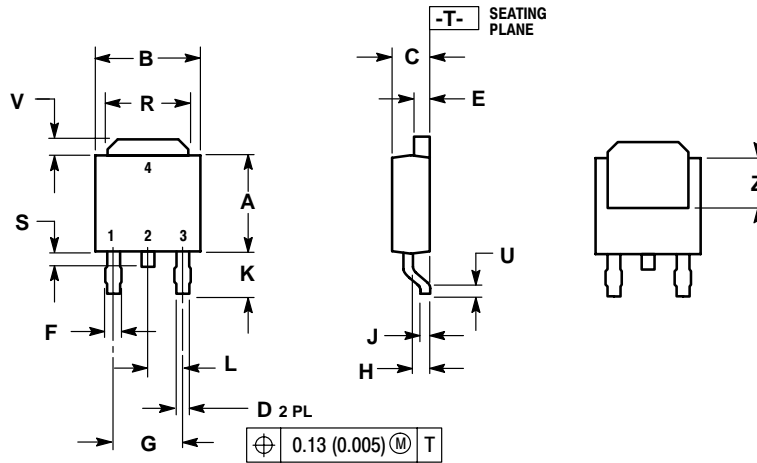

Figure 12. Thermal Response

# NID9N05CL

## PACKAGE DIMENSIONS

DPAK  
CASE 369A-13  
ISSUE AB



- NOTES:  
1. DIMENSIONING AND TOLERANCING PER ANSI Y14.5M, 1982.  
2. CONTROLLING DIMENSION: INCH.

DIM	INCHES		MILLIMETERS	
	MIN	MAX	MIN	MAX
A	0.235	0.250	5.97	6.35
B	0.250	0.265	6.35	6.73
C	0.086	0.094	2.19	2.38
D	0.027	0.035	0.69	0.88
E	0.033	0.040	0.84	1.01
F	0.037	0.047	0.94	1.19
G	0.180 BSC		4.58 BSC	
H	0.034	0.040	0.87	1.01
J	0.018	0.023	0.46	0.58
K	0.102	0.114	2.60	2.89
L	0.090 BSC		2.29 BSC	
R	0.175	0.215	4.45	5.46
S	0.020	0.050	0.51	1.27
U	0.020	---	0.51	---
V	0.030	0.050	0.77	1.27
Z	0.138	---	3.51	---

- STYLE 2:  
PIN 1. GATE  
2. DRAIN  
3. SOURCE  
4. DRAIN

ON Semiconductor and  are registered trademarks of Semiconductor Components Industries, LLC (SCILLC). SCILLC reserves the right to make changes without further notice to any products herein. SCILLC makes no warranty, representation or guarantee regarding the suitability of its products for any particular purpose, nor does SCILLC assume any liability arising out of the application or use of any product or circuit, and specifically disclaims any and all liability, including without limitation special, consequential or incidental damages. "Typical" parameters which may be provided in SCILLC data sheets and/or specifications can and do vary in different applications and actual performance may vary over time. All operating parameters, including "Typicals" must be validated for each customer application by customer's technical experts. SCILLC does not convey any license under its patent rights nor the rights of others. SCILLC products are not designed, intended, or authorized for use as components in systems intended for surgical implant into the body, or other applications intended to support or sustain life, or for any other application in which the failure of the SCILLC product could create a situation where personal injury or death may occur. Should Buyer purchase or use SCILLC products for any such unintended or unauthorized application, Buyer shall indemnify and hold SCILLC and its officers, employees, subsidiaries, affiliates, and distributors harmless against all claims, costs, damages, and expenses, and reasonable attorney fees arising out of, directly or indirectly, any claim of personal injury or death associated with such unintended or unauthorized use, even if such claim alleges that SCILLC was negligent regarding the design or manufacture of the part. SCILLC is an Equal Opportunity/Affirmative Action Employer.

### PUBLICATION ORDERING INFORMATION

#### Literature Fulfillment:

Literature Distribution Center for ON Semiconductor  
P.O. Box 5163, Denver, Colorado 80217 USA  
Phone: 303-675-2175 or 800-344-3860 Toll Free USA/Canada  
Fax: 303-675-2176 or 800-344-3867 Toll Free USA/Canada  
Email: ONlit@hibbertco.com

N. American Technical Support: 800-282-9855 Toll Free USA/Canada

JAPAN: ON Semiconductor, Japan Customer Focus Center  
2-9-1 Kamimeguro, Meguro-ku, Tokyo, Japan 153-0051  
Phone: 81-3-5773-3850

ON Semiconductor Website: <http://onsemi.com>

For additional information, please contact your local Sales Representative.

NID9N05CL/D