

# 7MBP75RTB060

## IPM-R3 series

600V / 75A 7 in one-package

### Features

- Temperature protection provided by directly detecting the junction temperature of the IGBTs
- Low power loss and soft switching
- High performance and high reliability IGBT with overheating protection
- Higher reliability because of a big decrease in number of parts in built-in control circuit

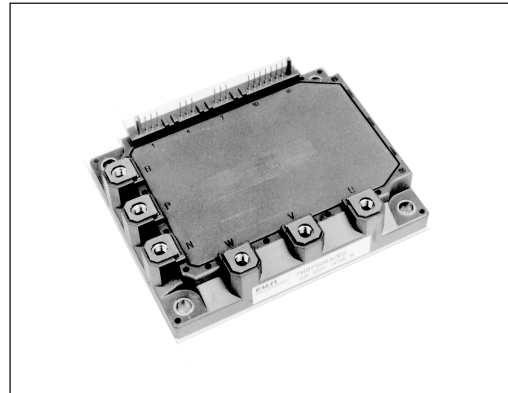

### Maximum ratings and characteristics

- Absolute maximum ratings(at Tc=25°C unless otherwise specified)

Item		Symbol	Rating		Unit	
			Min.	Max.		
Bus voltage (between terminal P and N)	DC	V <sub>dc</sub>	0	450	V	
	Surge	V <sub>DC(surge)</sub>	0	500	V	
	Shortoperating	V <sub>sc</sub>	200	400	V	
Collector-Emitter voltage		V <sub>CEs</sub> *1	0	600	V	
Inverter	Collector current	DC	I <sub>c</sub>	-	75	A
		1ms	I <sub>cP</sub>	-	150	A
		Duty=75.0%	-I <sub>c</sub> *2	-	75	A
Collector power dissipation		One transistor	P <sub>c</sub> *3	-	198	W
Brake	Collector current	DC	I <sub>c</sub>	-	50	A
		1ms	I <sub>cP</sub>	-	100	A
		Forward Current of Diode	I <sub>F</sub>	-	50	A
Collector power dissipation		One transistor	P <sub>c</sub> *3	-	198	W
Input voltage of power supply for Pre-Driver		V <sub>CC</sub> *4	-0.5	20	V	
Input signal voltage		V <sub>in</sub> *5	-0.5	V <sub>CC</sub> +0.5	V	
Input signal current		I <sub>in</sub>	-	3	mA	
Alarm signal voltage		V <sub>ALM</sub> *6	-0.5	V <sub>CC</sub>	V	
Alarm signal current		I <sub>ALM</sub> *7	-	20	mA	
Junction temperature		T <sub>j</sub>	-	150	°C	
Operating case temperature		T <sub>CP</sub>	-20	100	°C	
Storage temperature		T <sub>stg</sub>	-40	125	°C	
Isolating voltage (Case-Terminal)		V <sub>iso</sub> *8	-	AC2.5	kV	
Screw torque	Mounting (M5)		-	3.5 *9	N·m	
	Terminal (M5)		-	3.5 *9	N·m	

Note

\*1 : V<sub>ces</sub> shall be applied to the input voltage between terminal P and U or V or W or DB, N and U or V or W or DB.

\*2 :  $125^{\circ}\text{C}/\text{FWD } R_{th(j-c)} / (I_c \times V_F \text{ MAX}) = 125/0.855 / (75 \times 2.6) \times 100 = 75.0\%$

\*3 : P<sub>c</sub>=125°C/IGBT R<sub>th(j-c)</sub>=125/0.63=198W [Inverter]

P<sub>c</sub>=125°C/IGBT R<sub>th(j-c)</sub>=125/0.63=198W [Break]

\*4 : V<sub>CC</sub> shall be applied to the input voltage between terminal No. 3 and 1, 6 and 4, 9 and 7, 11 and 10.

\*5 : V<sub>in</sub> shall be applied to the input voltage between terminal No. 2 and 1, 5 and 4, 8 and 7, 12,13,14,15 and 10.

\*6 : V<sub>ALM</sub> shall be applied to the voltage between terminal No. 16 and 10.

\*7 : I<sub>ALM</sub> shall be applied to the input current to terminal No. 16.

\*8 : 50Hz/60Hz sine wave 1 minute.

\*9 : Recommendable Value : 2.5 to 3.0 N·m

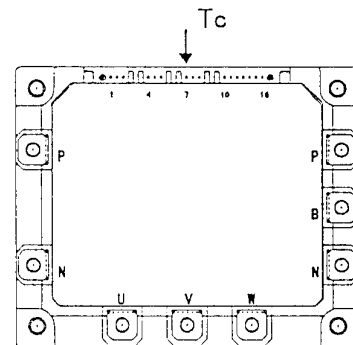

Fig.1 Measurement of case temperature

### Weight

Item	Symbol	Min.	Typ.	Max.	Unit
Weight	Wt	-	450	-	g

\*9 : (For 1 device, Case is under the device)

Electrical characteristics (at  $T_c=T_j=25^\circ\text{C}$ ,  $V_{cc}=15\text{V}$  unless otherwise specified.)

● Main circuit

Item		Symbol	Condition	Min.	Typ.	Max.	Unit	
Inverter	Collector current at off signal input	ICES	$V_{CE}=600\text{V}$ $V_{in}$ terminal open.	-	-	1.0	mA	
	Collector-Emitter saturation voltage	$V_{CE(sat)}$	Ic=75A	Terminal	-	-	2.4	V
				Chip	-	2.0	-	
	Forward voltage of FWD	$V_F$	Ic=75A	Terminal	-	-	2.6	V
Chip				-	1.6	-		
Brake	Collector current at off signal input	ICES	$V_{CE}=600\text{V}$ $V_{in}$ terminal open.	-	-	1.0	mA	
	Collector-Emitter saturation voltage	$V_{CE(sat)}$	Ic=50A	Terminal	-	-	2.2	V
				Chip	-	1.75	-	
	Forward voltage of Diode	$V_F$	-Ic=50A	Terminal	-	-	3.3	V
Chip				-	1.9	-	V	
Turn-on time	$t_{on}$	$V_{DC}=300\text{V}, T_j=125^\circ\text{C}$		1.2	-	-	$\mu\text{s}$	
Turn-off time	$t_{off}$	Ic=75A Fig.1, Fig.6		-	-	3.6		
Reverse recovery time	$t_{rr}$	$V_{DC}=300\text{V}, I_c=75\text{A}$ Fig.1, Fig.6		-	-	0.3		
Maximum Avalanche Energy (A non-repetition)	PAV	Internal wiring inductance=50nH Main circuit wiring inductance=54nH		40	-	-	mJ	

● Control circuit

Item	Symbol	Condition	Min.	Typ.	Max.	Unit
Supply current of P-line side pre-driver(one unit)	$I_{ccp}$	Switching Frequency : 0 to 15kHz $T_c=-20$ to $125^\circ\text{C}$ Fig.7	-	-	18	mA
Supply current of N-line side pre-driver	$I_{ccn}$		-	-	65	mA
Input signal threshold voltage (on/off)	$V_{in(th)}$	ON	1.00	1.35	1.70	V
		OFF	1.25	1.60	1.95	V
Input zener voltage	$V_Z$	$R_{in}=20\text{k ohm}$	-	8.0	-	V
Alarm signal hold time	tALM	$T_c=-20^\circ\text{C}$ Fig.2	1.1	-	-	ms
		$T_c=25^\circ\text{C}$ Fig.2	-	2.0	-	ms
		$T_c=125^\circ\text{C}$ Fig.2	-	-	4.0	ms
Limiting resistor for alarm	RALM		1425	1500	1575	ohm

● Protection Section (  $V_{cc}=15\text{V}$  )

Item	Symbol	Condition	Min.	Typ.	Max.	Unit
Over Current Protection Level of Inverter circuit	Ioc	$T_j=125^\circ\text{C}$	113	-	-	A
Over Current Protection Level of brake circuit		$T_j=125^\circ\text{C}$	75	-	-	A
Over Current Protection Delay time	tDOC	$T_j=125^\circ\text{C}$	-	5	-	$\mu\text{s}$
SC Protection Delay time	tSC	$T_j=125^\circ\text{C}$ Fig.4	-	-	8	$\mu\text{s}$
IGBT Chip Over Heating	$T_{jOH}$	surface of IGBT chips	150	-	-	$^\circ\text{C}$
Over Heating Protection Hysteresis	$T_{jH}$		-	20	-	$^\circ\text{C}$
Over Heating Protection Temperature Level	$T_{COH}$	$V_{DC}=0\text{V}, I_c=0\text{A}$ , Case temperature	110	-	125	$^\circ\text{C}$
Over Heating Protection Hysteresis	TCH		-	20	-	
Under Voltage Protection Level	$V_{UV}$		11.0	-	12.5	V
Under Voltage Protection Hysteresis	$V_H$		0.2	0.5	-	

● Thermal characteristics(  $T_c=25^\circ\text{C}$  )

Item	Symbol		Min.	Typ.	Max.	Unit
Junction to Case thermal resistance	INV	IGBT	-	-	0.63	$^\circ\text{C/W}$
		FWD	-	-	0.855	$^\circ\text{C/W}$
	Brake	IGBT	-	-	0.63	$^\circ\text{C/W}$
Case to fin thermal resistance with compound	Rth(c-f)		-	0.05	-	$^\circ\text{C/W}$

● Noise Immunity (  $V_{DC}=300\text{V}, V_{cc}=15\text{V}$ , Test Circuit Fig.5)

Item	Condition	Min.	Typ.	Max.	Unit
Common mode rectangular noise	Pulse width $1\mu\text{s}$ , polarity $\pm 10\text{minuets}$ Judge : no over-current, no miss operating	$\pm 2.0$	-	-	kV
Common mode lightning surge	Rise time $1.2\mu\text{s}$ , Fall time $50\mu\text{s}$ Interval 20s, 10 times Judge : no over-current, no miss operating	$\pm 5.0$	-	-	kV

● Recommendable value

Item	Symbol	Min.	Typ.	Max.	Unit
DC Bus Voltage	$V_{DC}$	-	-	400	V
Operating Supply Voltage of Pre-Driver	$V_{cc}$	13.5	15.0	16.5	V
Screw torque (M5)	-	2.5	-	3.0	Nm

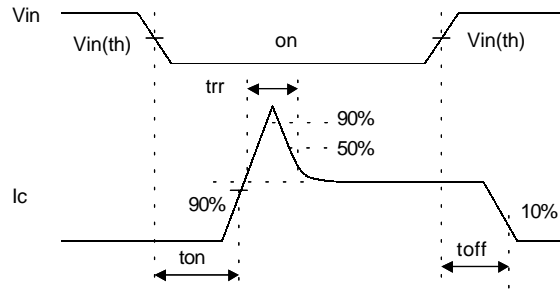
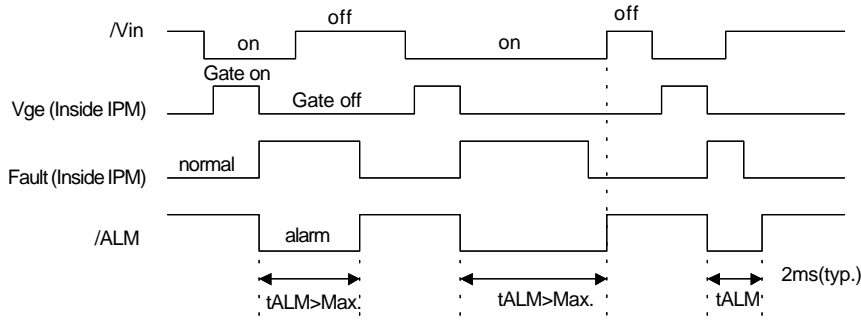

Figure 1. Switching Time Waveform Definitions



Fault : Over-current, Over-heat or Under-voltage

Figure 2. Input / Output Timing Diagram

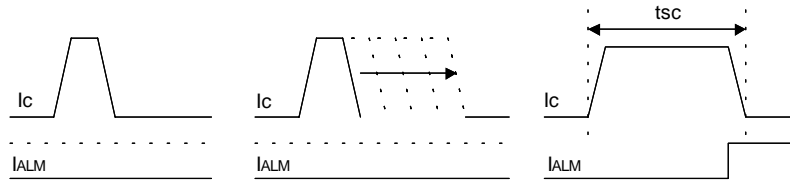

Figure 4 Definition of tsc

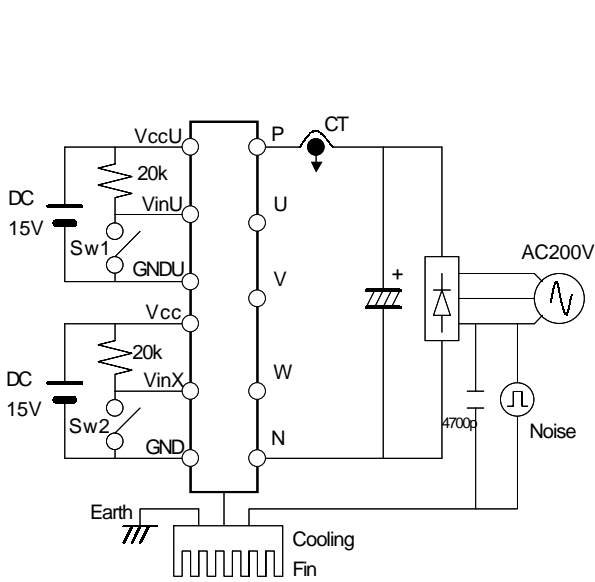

Figure 5. Noise Test Circuit

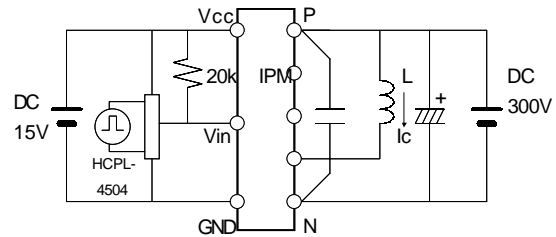

Figure 6. Switching Characteristics Test Circuit

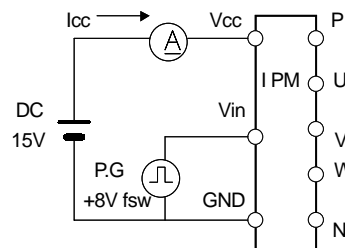
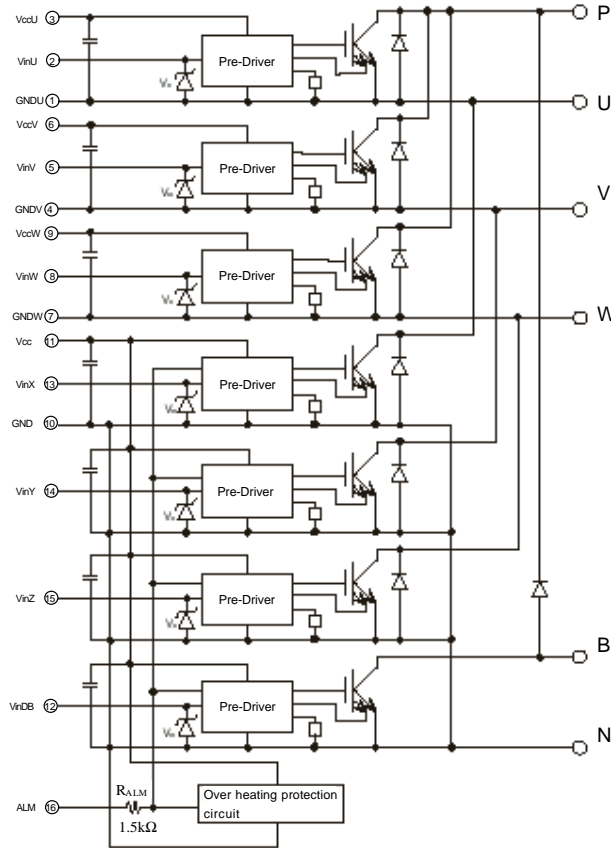

Figure 7. Icc Test Circuit

Block diagram



- Pre-driver include following functions
- ① Amplifier for drive
  - ② Short circuit protection
  - ③ Under voltage lockout circuit
  - ④ Over current protection
  - ⑤ IGBT chip over heating protection

Outline drawings, mm

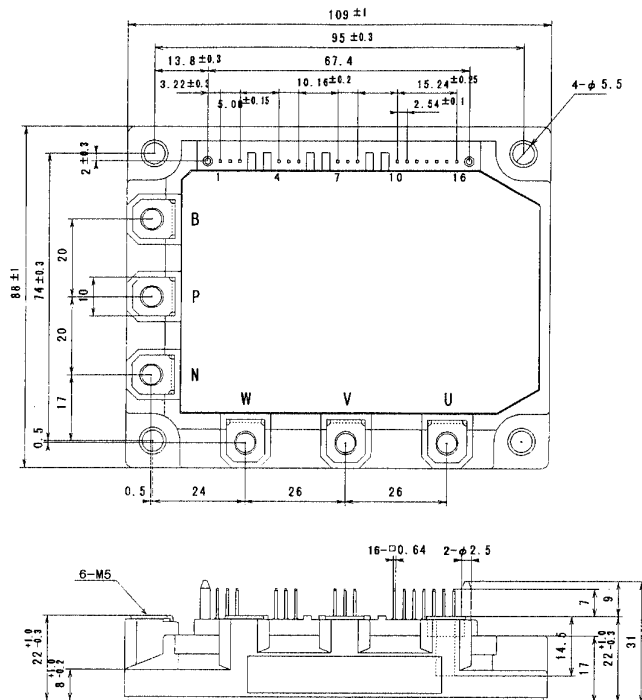

Mass : 450g

Characteristics

Control circuit characteristics (Representative)

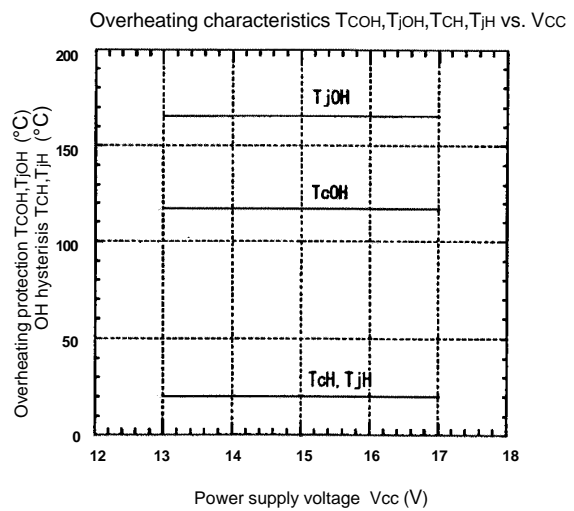
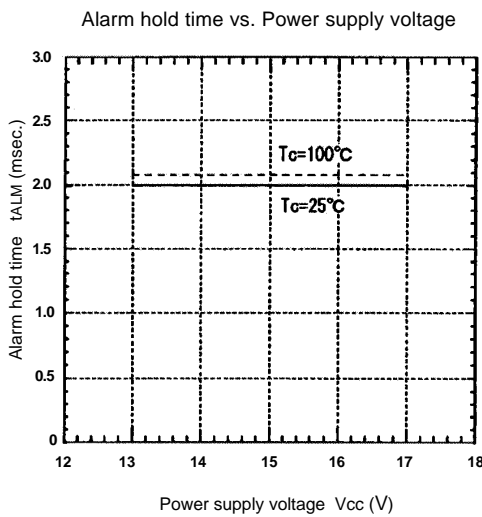
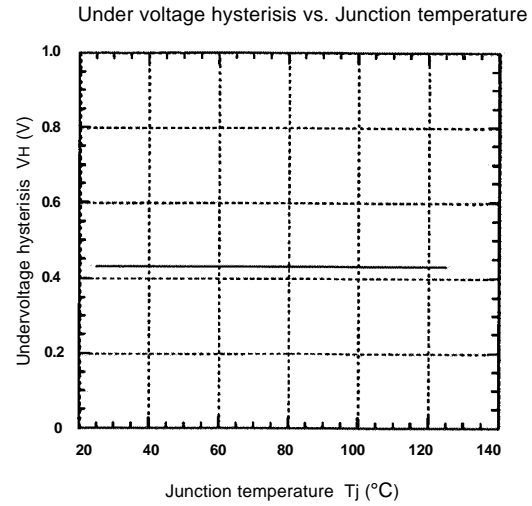
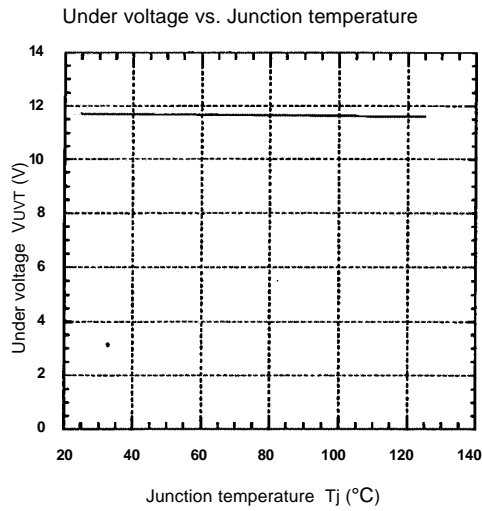
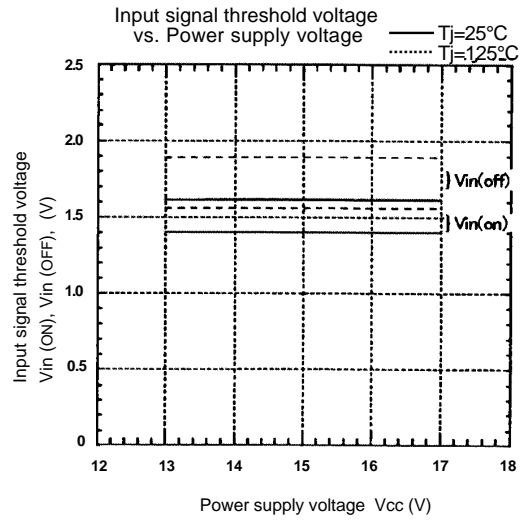
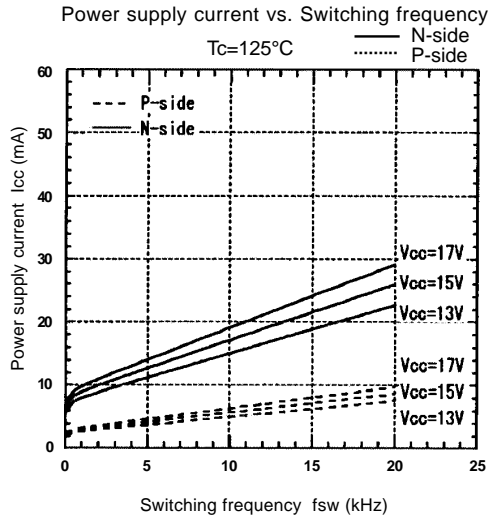

● Main circuit characteristics (Representative)

Collector current vs. Collector-Emittter voltage  
T<sub>j</sub>=25°C(Chip)

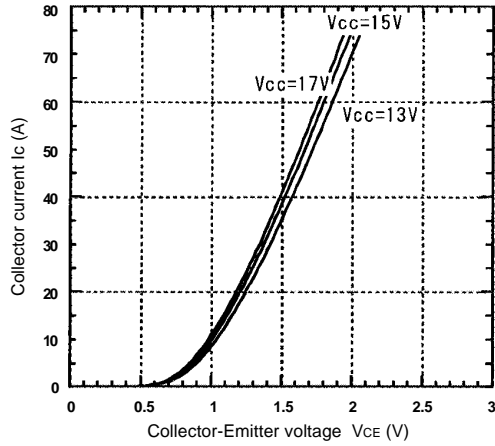

Collector current vs. Collector-Emittter voltage  
T<sub>j</sub>=25°C(Terminal)

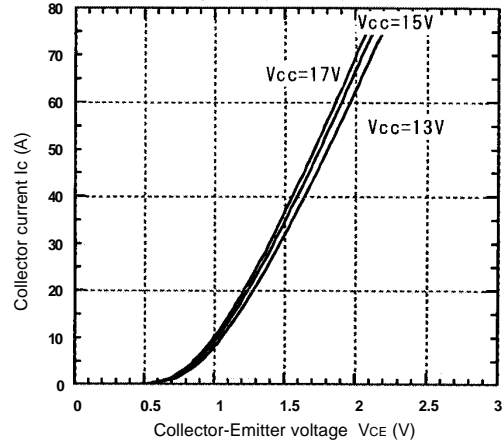

Collector current vs. Collector-Emittter voltage  
T<sub>j</sub>=125°C(Chip)

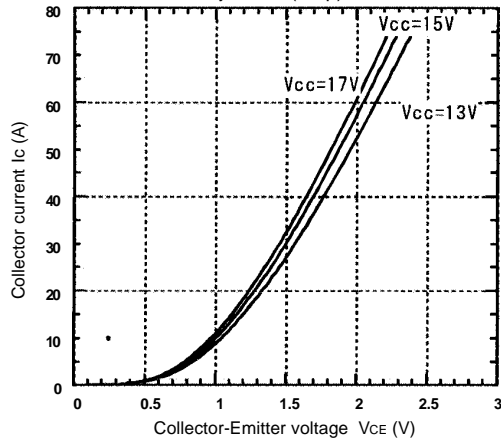

Collector current vs. Collector-Emittter voltage  
T<sub>j</sub>=125°C(Terminal)

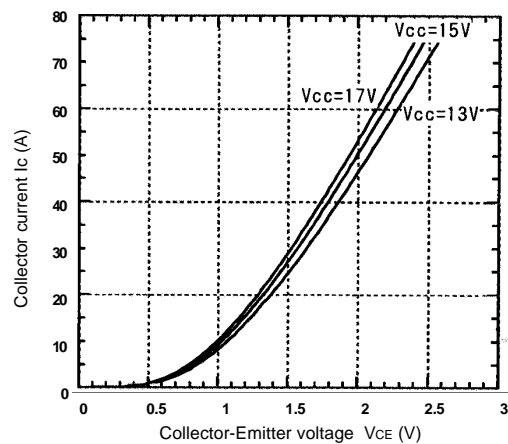

Forward current vs. Forward voltage  
(Chip)

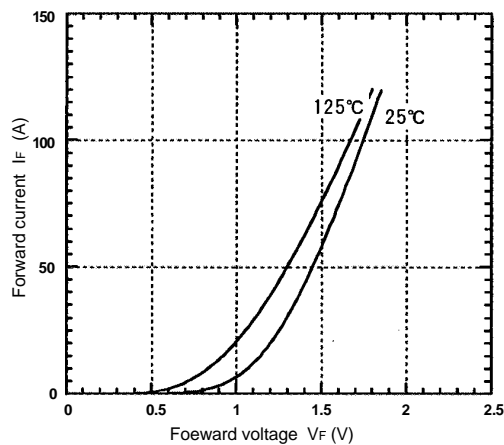

Forward current vs. Forward voltage  
(Terminal)

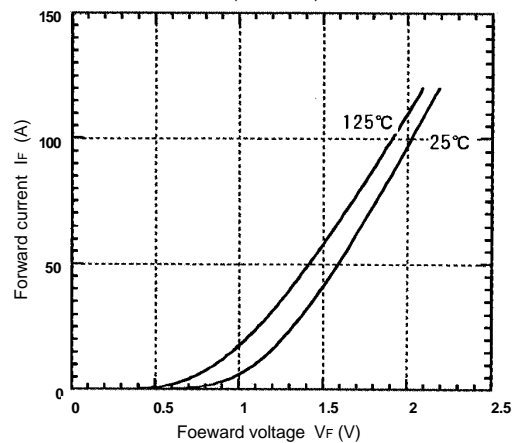

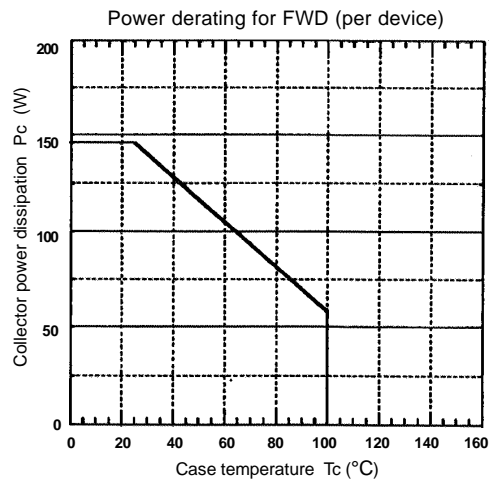
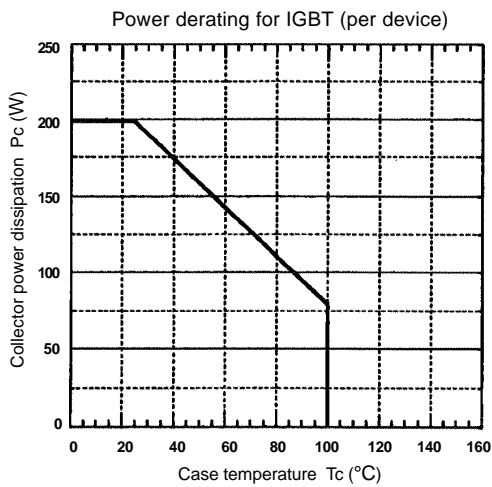
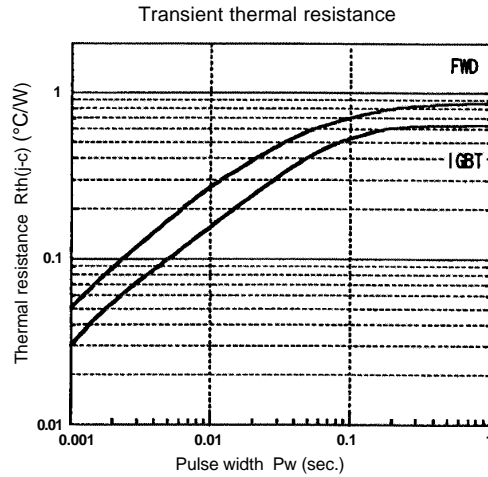
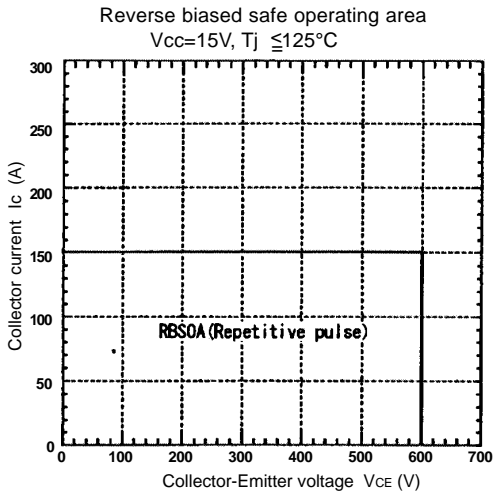
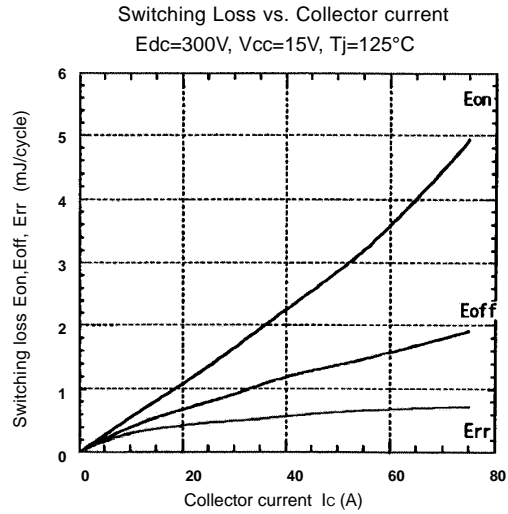
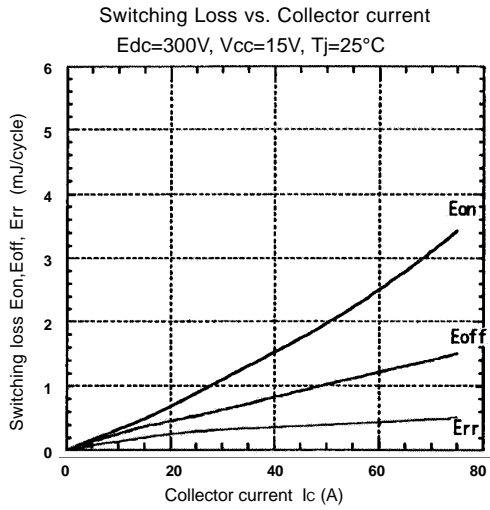

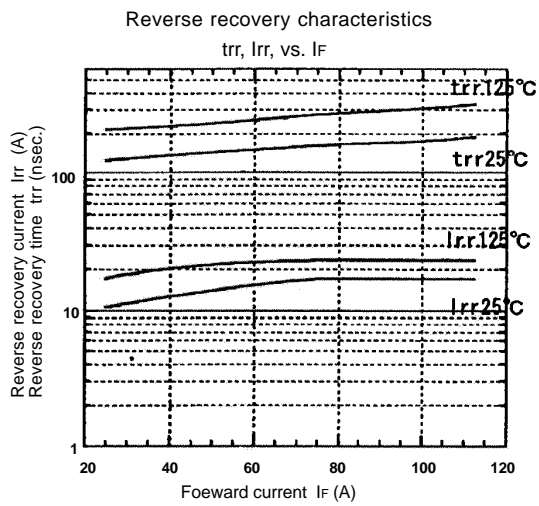
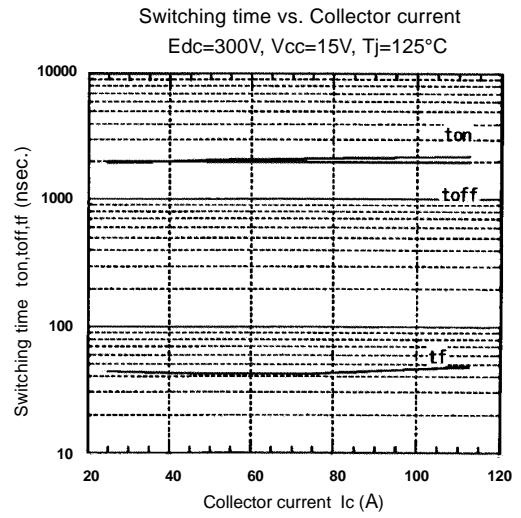
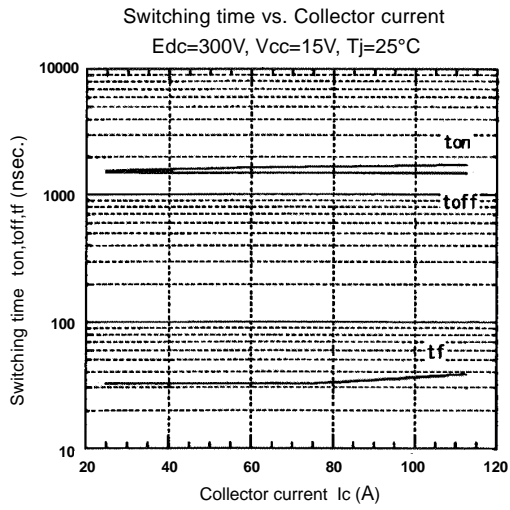



● Dynamic brake characteristics (Representative)

