

High-performance Clock Generator Series

Compact 1ch Clock Generators for Digital Cameras



BU3071HFV, BU3072HFV, BU3073HFV, BU3076HFV BU7322HFV, BU7325HFV

●Description

These Clock Generators incorporates compact package compared to oscillators, which provides the generation of high-frequency CCD, USB, VIDEO clocks necessary for digital still cameras and digital video cameras.

●Features

- 1) SEL pin allowing for the selection of frequencies
- 2) Selection of OE pin enabling Power-down function
- 3) Crystal-oscillator-level clock precision with high C/N characteristics and low jitter
- 4) Microminiature HVSO6 Package incorporated
- 5) Single power supply of 3.3 V

●Applications

Digital Still Camera, Digital Video Camera, and others

●Lineup

	BU3071HFV	BU3072HFV	BU3073HFV	BU3076HFV	BU7322HFV	BU7325HFV
Supply voltage	3.0 V~3.6V	3.0 V~3.6V	3.0 V~3.6V	2.85 V~3.6V	2.85 V~3.6V	2.85 V~3.6V
Operating temperature range	-5°C~70°C	-5°C~70°C	-5°C~70°C	-5°C~75°C	-5°C~75°C	-30°C~85°C
Reference input clock	28.6363MHz	48.0000MHz	48.0000MHz	27.0000MHz	27.0000MHz	27.0000MHz
Output clock	54.0000MHz	27.0000MHz	24.3750MHz	54.0000MHz	49.5000MHz	48.0000MHz
	-	36.0000MHz	24.5454MHz	67.5000MHz	36.0000MHz	78.0000MHz
Power-down function	Provided	Provided	Provided	Provided	Provided	Provided
Operating current (TYP)	10mA	11mA	11mA	12mA	10mA	12mA
Package	HVSO6	HVSO6	HVSO6	HVSO6	HVSO6	HVSO6

●Absolute Maximum Ratings (Ta=25°C)

	Symbol	Limit	Unit
Supply voltage	VDD	-0.3~4.0	V
Input voltage	VIN	-0.3~VDD+0.3	V
Storage temperature range	Tstg	-30~125	°C
Power dissipation	Pd	410	mW

*1 Operating is not guaranteed.

*2 In the case of exceeding Ta = 25°C, 4.1mW should be reduced per 1°C.

*3 The radiation-resistance design is not carried out.

*4 Power dissipation is measured when the IC is mounted to the printed circuit board.

● Recommended Operating Range

Parameter	Symbol	Limit	Unit
Supply voltage	VDD	3.0~3.6	V
Input H voltage	VINH	0.8VDD~VDD	V
Input L voltage	VINL	0.0~0.2VDD	V
Operating temperature	Topr	-5~70	°C
Output load	CL	15(MAX)	pF

● Electrical characteristics

BU3071HFV (Ta=25°C, VDD=3.3V, Crystal frequency=28.6363MHz, unless otherwise specified.)

Parameter	Symbol	Min.	Typ.	Max.	Unit	Conditions
Output H voltage	VOH	2.8	-	-	V	IOH=-4.0mA
Output L voltage	VOL	-	-	0.5	V	IOL=4.0mA
Consumption current 1	IDD1	-	10	15	mA	OE=H, at no load
Consumption current 2	IDD2	-	1	1.3	mA	OE=L
Output frequency		-	54.0000	-	MHz	IN*264/35/4
The following parameters represent design guaranteed performance.						
Duty	Duty	45	50	55	%	Measured at a voltage of 1/2 of VDD
Period-Jitter 1 σ	PJsSD	-	50	-	psec	※1
Period-Jitter MIN-MAX	PJsABS	-	300	-	psec	※2
Rise time	tr	-	2.5	-	nsec	Period of transition time required for the output to reach 80% from 20% of VDD. Provided with 15pF output load.
Fall time	tf	-	2.5	-	nsec	Period of transition time required for the output to reach 20% from 80% of VDD. Provided with 15pF output load.
Output Lock time	tLOCK	-	-	1	msec	※3

Note) The output frequency is determined by the arithmetic (frequency division) expression of a frequency input to IN. If the input frequency is set to 28.6363MHz, the output frequency will be as listed above.

BU3072HFV (Ta=25°C, VDD=3.3V, Crystal frequency=48.0000MHz, unless otherwise specified.)

Parameter	Symbol	Min.	Typ.	Max.	Unit	Conditions
Output H voltage	VOH	2.8	-	-	V	IOH=-4.0mA
Output L voltage	VOL	-	-	0.5	V	IOL=4.0mA
Consumption current 1	IDD1	-	11	16	mA	PD=H, at no load
Consumption current 2	IDD2	-	-	5	μ A	PD=L
Output frequency	CLK_27	-	27.0000	-	MHz	SEL=L, IN*18/8/4
	CLK_36	-	36.0000	-	MHz	SEL=H, IN*24/8/4
The following parameters represent design guaranteed performance.						
Duty	Duty	45	50	55	%	Measured at a voltage of 1/2 of VDD
Period-Jitter 1 σ	PJsSD	-	35	-	psec	※1
Long-Term-Jitter MIN-MAX	LTJsABS	-	0.9	1.5	nsec	MIN-MAX of long-term jitter (100 μ sec from trigger)
Rise time	tr	-	2.5	-	nsec	Period of transition time required for the output to reach 80% from 20% of VDD. Provided with 15pF output load.
Fall time	tf	-	2.5	-	nsec	Period of transition time required for the output to reach 20% from 80% of VDD. Provided with 15pF output load.
Output Lock time	tLOCK	-	-	1	msec	※3

Note) The output frequency is determined by the arithmetic (frequency division) expression of a frequency input to IN. If the input frequency is set to 48.0000MHz, the output frequency will be as listed above.

BU3073HFV (Ta=25°C, VDD=3.3V, Crystal frequency=48.0000MHz, unless otherwise specified.)

Parameter	Symbol	Min.	Typ.	Max.	Unit	Conditions
Output H voltage	VOH	2.8	-	-	V	IOH=-4.0mA
Output L voltage	VOL	-	-	0.5	V	IOL=4.0mA
Consumption current 1	IDD1	-	11	16	mA	PD=H, at no load
Consumption current 2	IDD2	-	-	5	mA	PD=L
Output frequency	CLK_375	-	24.3750	-	MHz	SEL=L, IN*65/16/8
	CLK_545	-	24.5454	-	MHz	SEL=H, IN*45/11/8
The following parameters represent design guaranteed performance.						
Duty	Duty	45	50	55	%	Measured at a voltage of 1/2 of VDD
Period-Jitter 1 σ	PJsSD	-	45	-	psec	※1
Long-Term-Jitter MIN-MAX	LTJsABS	-	0.9	1.5	nsec	MIN-MAX of long-term jitter (100 μ sec from trigger)
Rise time	tr	-	2.5	-	nsec	Period of transition time required for the output to reach 80% from 20% of VDD. Provided with 15pF output load.
Fall time	tf	-	2.5	-	nsec	Period of transition time required for the output to reach 20% from 80% of VDD. Provided with 15pF output load.
Output Lock time	tLOCK	-	-	1	msec	※3

Note) The output frequency is determined by the arithmetic (frequency division) expression of a frequency input to IN.
If the input frequency is set to 48.0000MHz, the output frequency will be as listed above.

BU3076HFV (Ta=25°C, VDD=3.3V, Crystal frequency=27.0000MHz, unless otherwise specified.)

Parameter	Symbol	Min.	Typ.	Max.	Unit	Conditions
Output H voltage	VOH	2.8	-	-	V	IOH=-4.0mA
Output L voltage	VOL	-	-	0.5	V	IOL=4.0mA
Pull-down resistance	Rpd	25	50	100	K Ω	Pull-down resistance on input pin
Consumption current 1	IDD1	-	10	15	mA	54MHz output, at no load
Consumption current 2	IDD2	-	12	18	mA	67.5MHz output, at no load
Standby current	IDDst	-	-	1	μ A	OE=L
Output frequency	CLK_54	-	54.0000	-	MHz	SEL=L, IN*48/6/4
	CLK_67.5	-	67.5000	-	MHz	SEL=H, IN*60/6/4
The following parameters represent design guaranteed performance.						
Duty	Duty	45	50	55	%	Measured at a voltage of 1/2 of VDD
Period-Jitter 1 σ	PJsSD	-	50	-	psec	※1
Period-Jitter MIN-MAX	PJsABS	-	300	-	psec	※2
Rise time	tr	-	1.5	-	nsec	Period of transition time required for the output to reach 80% from 20% of VDD. Provided with 15pF output load.
Fall time	tf	-	1.5	-	nsec	Period of transition time required for the output to reach 20% from 80% of VDD. Provided with 15pF output load.
Output Lock time	tLOCK	-	-	200	usec	※3

Note) The output frequency is determined by the arithmetic (frequency division) expression of a frequency input to IN.
If the input frequency is set to 27.0000MHz, the output frequency will be as listed above.

BU7322HFV (Ta=25°C, VDD=3.3V, Crystal frequency=27.0000MHz, unless otherwise specified.)

Parameter	Symbol	Min.	Typ.	Max.	Unit	Conditions
Output H voltage	VOH	2.8	-	-	V	IOH=-4.0mA
Output L voltage	VOL	-	-	0.5	V	IOL=4.0mA
Pull-down resistance	Rpd	25	50	100	kΩ	Pull-down resistance on input pin
Consumption current 1	IDD	-	10	13.5	mA	49.5MHz output, at no load
Consumption current 2	IDD2	-	9.5	13.0	mA	36.0MHz output, at no load
Standby current	IDDst	-	-	1	μA	OE=L
Output frequency	CLK_49.5	-	49.5000	-	MHz	SEL=L, IN*66/6/6
	CLK_36	-	36.0000	-	MHz	SEL=H, IN*64/6/8

The following parameters represent design guaranteed performance.

Duty	Duty	45	50	55	%	Measured at a voltage of 1/2 of VDD
Period-Jitter 1σ	PJsSD	-	50	-	psec	※1
Period-Jitter MIN-MAX	PJsABS	-	300	-	psec	※2
Rise time	tr	-	2.5	-	nsec	Period of transition time required for the output to reach 80% from 20% of VDD. Provided with 15pF output load.
Fall time	tf	-	2.5	-	nsec	Period of transition time required for the output to reach 20% from 80% of VDD. Provided with 15pF output load.
Output Lock time	tLOCK	-	-	200	usec	※3

Note) The output frequency is determined by the arithmetic (frequency division) expression of a frequency input to IN.

If the input frequency is set to 27.0000MHz, the output frequency will be as listed above.

BU7325HFV (Ta=25°C, VDD=3.3V, Crystal frequency=27.0000MHz, unless otherwise specified.)

Parameter	Symbol	Min.	Typ.	Max.	Unit	Conditions
Output H voltage	VOH	2.8	-	-	V	IOH=-4.0mA
Output L voltage	VOL	-	-	0.5	V	IOL=4.0mA
Pull-down resistance	Rpd	25	50	100	kΩ	Pull-down resistance on input pin
Consumption current 1	IDD1	-	11	15	mA	OE=H, SEL=L, at no load
Consumption current 2	IDD2	-	12	16.5	mA	OE=H, SEL=H, at no load
Standby current	IDDst	-	-	1	μA	OE=L
Output frequency	CLK_48	-	48.0000	-	MHz	SEL=L, IN*96/9/6
	CLK_78	-	78.0000	-	MHz	SEL=H, IN*104/9/4

The following parameters represent design guaranteed performance.

Duty	Duty	45	50	55	%	Measured at a voltage of 1/2 of VDD
Period-Jitter 1σ	PJsSD	-	50	-	psec	※1
Period-Jitter MIN-MAX	PJsABS	-	300	-	psec	※2
Rise time	tr	-	1.5	-	nsec	Period of transition time required for the output to reach 80% from 20% of VDD. Provided with 15pF output load.
Fall time	tf	-	1.5	-	nsec	Period of transition time required for the output to reach 20% from 80% of VDD. Provided with 15pF output load.
Output Lock time	tLOCK	-	-	200	usec	※3

Note) The output frequency is determined by the arithmetic (frequency division) expression of a frequency input to IN.

If the input frequency is set to 27.0000MHz, the output frequency will be as listed above.

Common to BU3071HFV, BU3072HFV, BU3073HFV, BU3076HFV, BU7322HFV, BU7325HFV

*1 Period-Jitter 1σ

This parameter represents standard deviation (=1σ) on cycle distribution data at the time when the output clock cycles are sampled 1000 times consecutively with the TDS7104 Digital Phosphor Oscilloscope of Tektronix Japan, Ltd.

*2 Period-Jitter MIN-MAX

This parameter represents a maximum distribution width on cycle distribution data at the time when the output clock cycles are sampled 1000 times consecutively with the TDS7104 Digital Phosphor Oscilloscope of Tektronix Japan, Ltd.

*3 Output Lock Time

This parameter represents elapsed time after power supply turns ON to reach a voltage of 3.0 V, after the system is switched from Power-Down state to normal operation state, or after the output frequency is switched, until it is stabilized at a specified frequency, respectively.

●Reference data (BU3071HFV basic data)

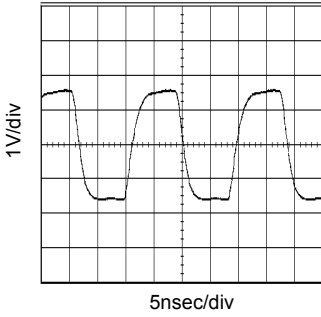

Fig.1 54MHz output waveform
(VDD=3.3V,CL=15pF,Ta=25°C)

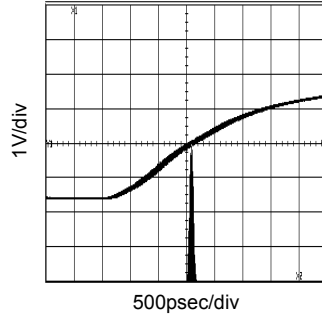

Fig.2 54MHz Period-Jitter
(VDD=3.3V,CL=15pF,Ta=25°C)

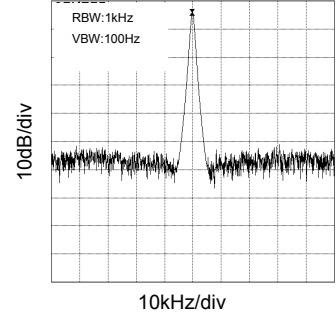

Fig.3 54MHz spectrum
(VDD=3.3V,CL=15pF,Ta=25°C)

●Reference data (BU3072HFV basic data)

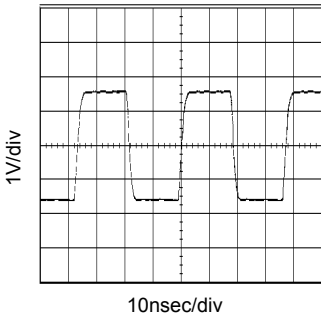

Fig.4 27MHz output waveform
(VDD=3.3V,CL=15pF,Ta=25°C)

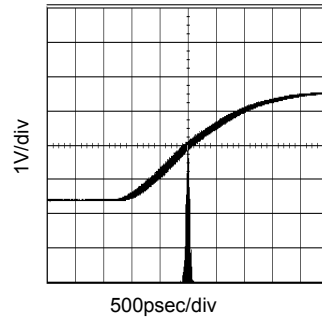

Fig.5 27MHz Period-Jitter
(VDD=3.3V,CL=15pF,Ta=25°C)

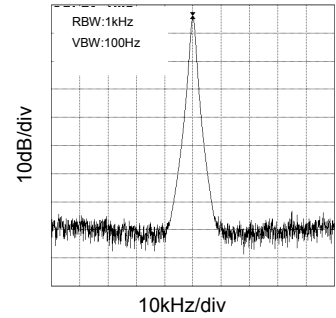

Fig.6 27MHz spectrum
(VDD=3.3V,CL=15pF,Ta=25°C)

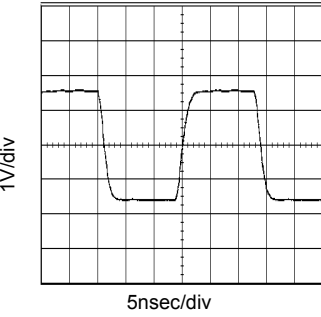

Fig.7 36MHz output waveform
(VDD=3.3V,CL=15pF,Ta=25°C)

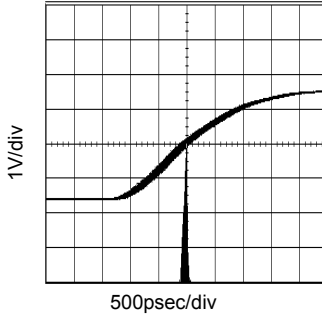

Fig.8 36MHz Period-Jitter
(VDD=3.3V,CL=15pF,Ta=25°C)

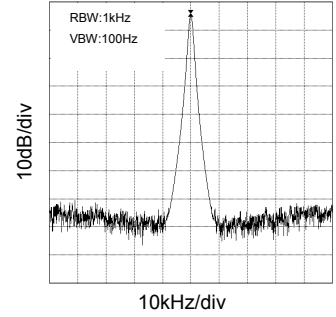

Fig.9 36MHz spectrum
(VDD=3.3V,CL=15pF,Ta=25°C)

●Reference data (BU3073HFV basic data)

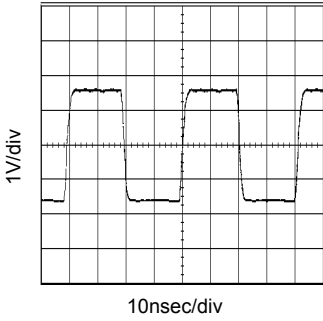

Fig.10 24.375MHz output waveform (VDD=3.3V,CL=15pF,Ta=25°C)

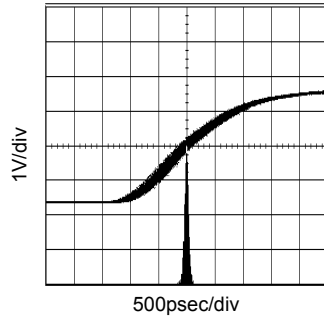

Fig.11 24.375MHz Period-Jitter (VDD=3.3V,CL=15pF,Ta=25°C)

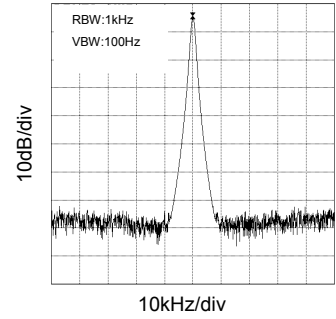

Fig.12 24.375MHz spectrum (VDD=3.3V,CL=15pF,Ta=25°C)

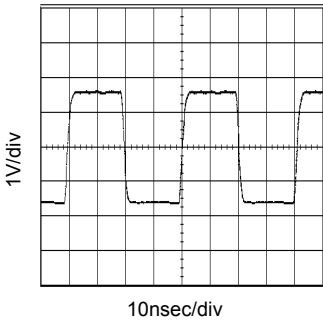

Fig.13 24.5454MHz output waveform (VDD=3.3V,CL=15pF,Ta=25°C)

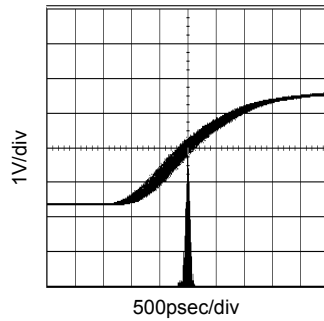

Fig.14 24.5454MHz Period-Jitter (VDD=3.3V,CL=15pF,Ta=25°C)

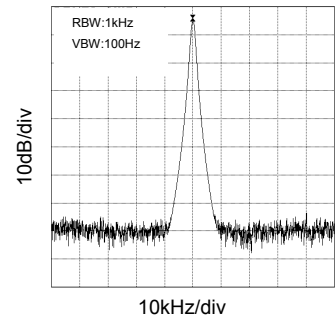

Fig.15 24.5454MHz spectrum (VDD=3.3V,CL=15pF,Ta=25°C)

●Reference data (BU3076HFV basic data)

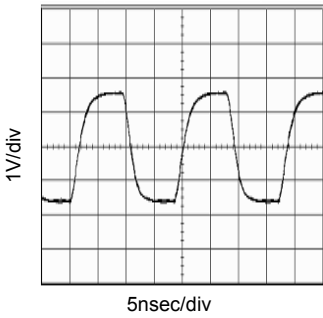

Fig.16 54MHz output waveform (VDD=3.3V,CL=15pF,Ta=25°C)

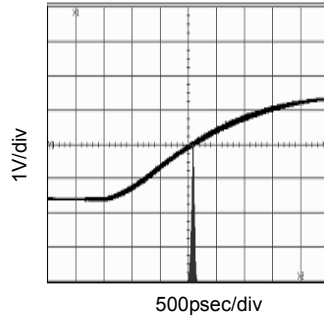

Fig.17 54MHz Period-Jitter (VDD=3.3V,CL=15pF,Ta=25°C)

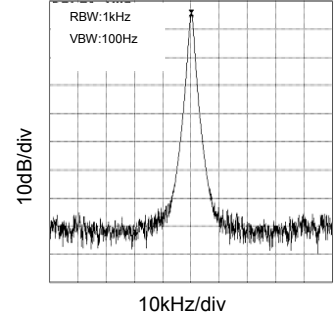

Fig.18 54MHz spectrum (VDD=3.3V,CL=15pF,Ta=25°C)

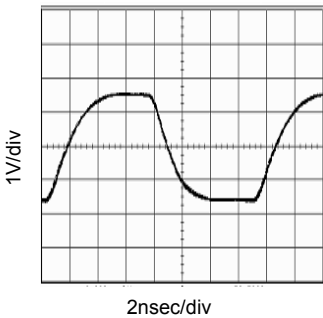

Fig.19 67.5MHz output waveform (VDD=3.3V,CL=15pF,Ta=25°C)

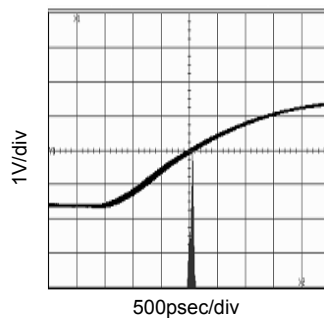

Fig.20 67.5MHz Period-Jitter (VDD=3.3V,CL=15pF,Ta=25°C)

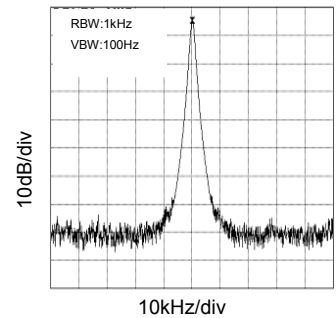

Fig.21 67.5MHz spectrum (VDD=3.3V,CL=15pF,Ta=25°C)

●Reference data (BU7322HFV basic data)

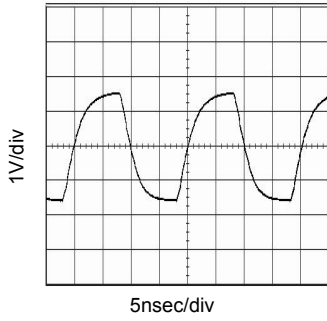

Fig.22 49.5MHz output waveform (VDD=3.3V,CL=15pF,Ta=25°C)

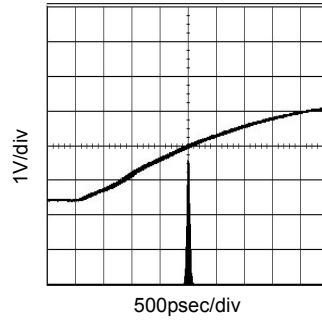

Fig.23 49.5MHz Period-Jitter (VDD=3.3V,CL=15pF,Ta=25°C)

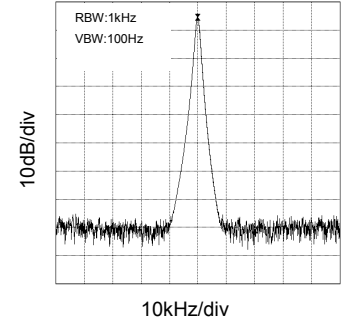

Fig.24 49.5MHz spectrum (VDD=3.3V,CL=15pF,Ta=25°C)

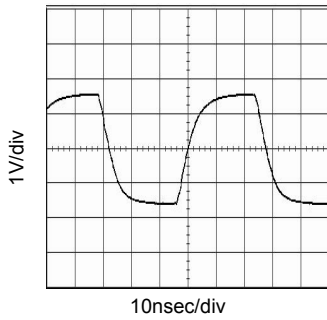

Fig.25 36MHz output waveform (VDD=3.3V,CL=15pF,Ta=25°C)

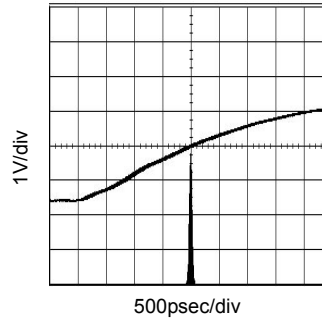

Fig.26 36MHz Period-Jitter (VDD=3.3V,CL=15pF,Ta=25°C)

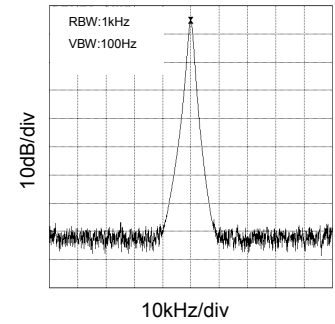

Fig.27 36MHz spectrum (VDD=3.3V,CL=15pF,Ta=25°C)

●Reference data (BU7325HFV basic data)

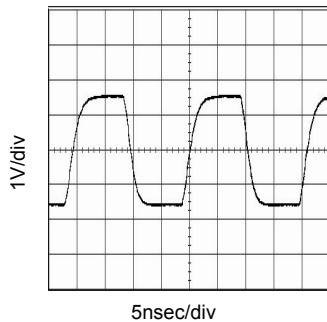

Fig.28 48MHz output waveform (VDD=3.3V,CL=15pF,Ta=25°C)

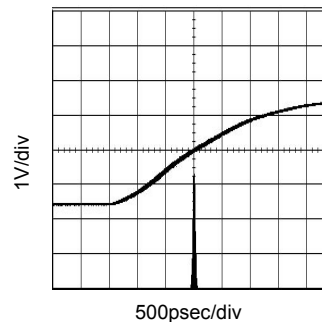

Fig.29 48MHz Period-Jitter (VDD=3.3V,CL=15pF,Ta=25°C)

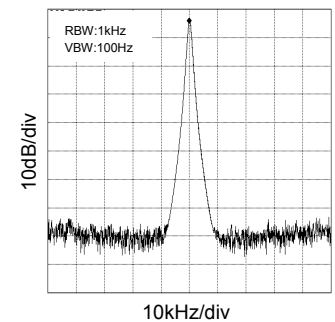

Fig.30 48MHz spectrum (VDD=3.3V,CL=15pF,Ta=25°C)

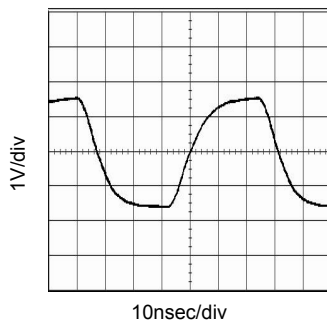

Fig.31 78MHz output waveform (VDD=3.3V,CL=15pF,Ta=25°C)

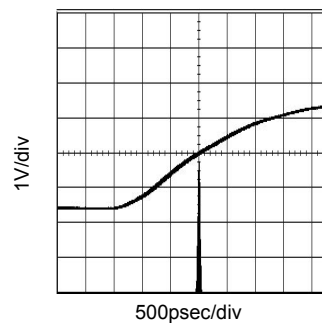

Fig.32 78MHz Period-Jitter (VDD=3.3V,CL=15pF,Ta=25°C)

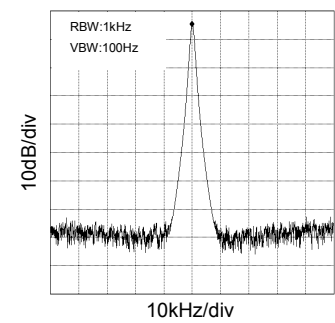
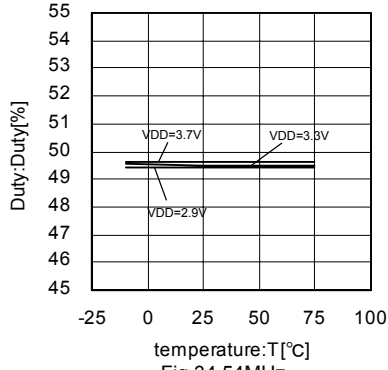
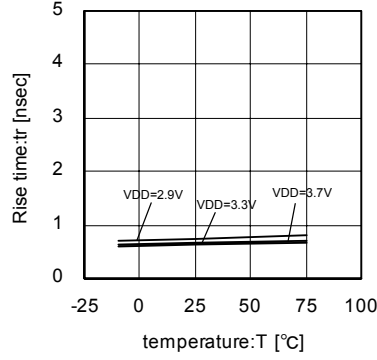

Fig.33 78MHz spectrum (VDD=3.3V,CL=15pF,Ta=25°C)

●Reference data (BU3071HFV Temperature and Supply voltage variations data)



Duty temperature characteristics



Rise-time temperature characteristics

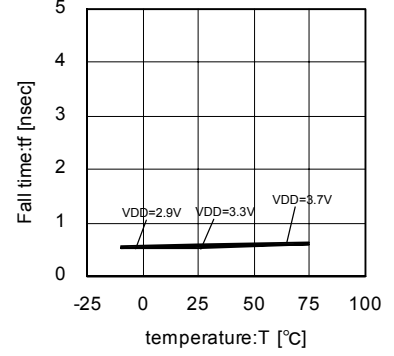

Fall-time temperature characteristics

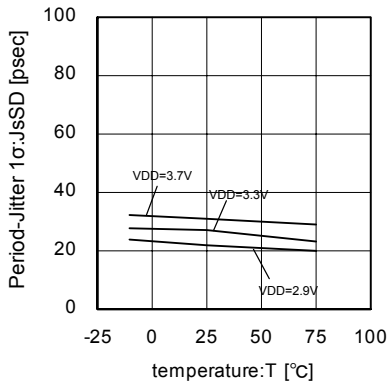

Period-Jitter 1σ temperature characteristics

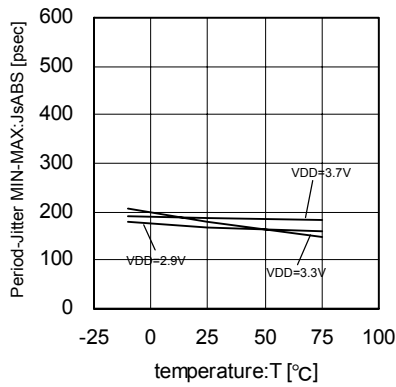

Jitter-MinMax temperature characteristics

● Reference data (BU3072HFV Temperature and Supply voltage variations data)

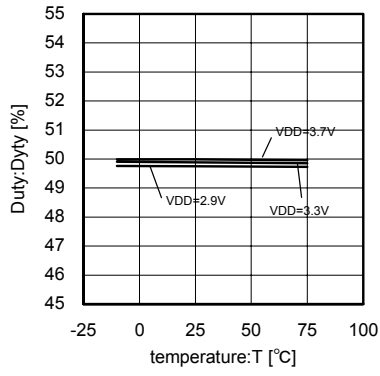

Fig. 39 27MHz
Duty temperature characteristics

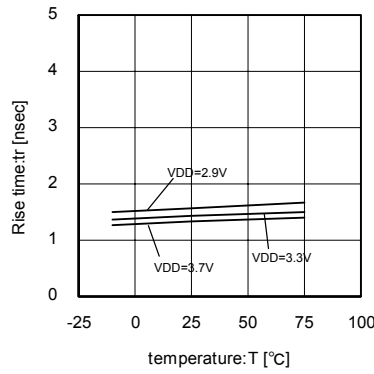

Fig. 40 27MHz
Rise-time temperature characteristics

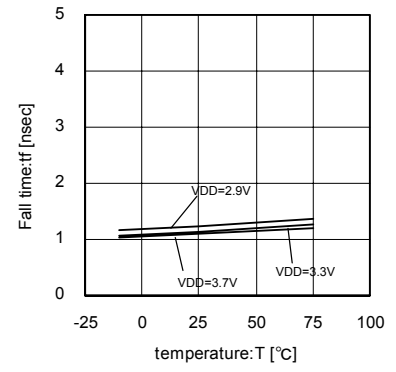

Fig. 41 27MHz
Fall-time temperature characteristics

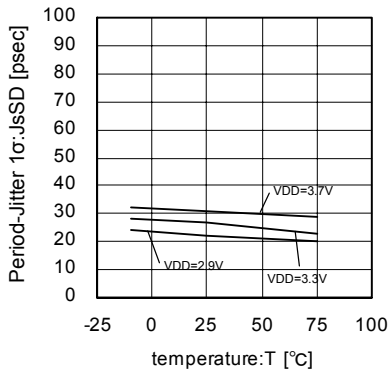

Fig. 42 27MHz
Period-Jitter 1 σ temperature characteristics

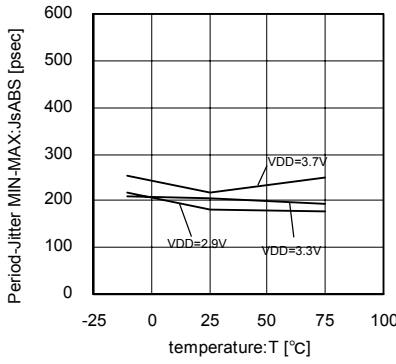

Fig. 43 27MHz
Jitter-MinMax temperature characteristics

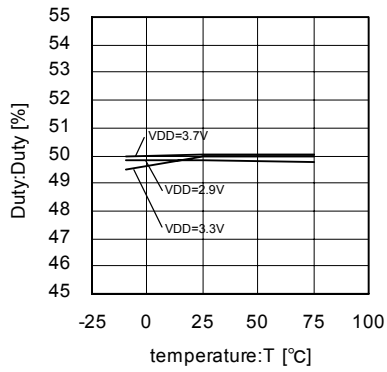

Fig. 44 36MHz
Duty temperature characteristics

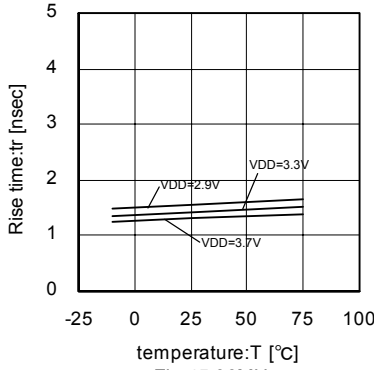

Fig. 45 36MHz
Rise-time temperature characteristics

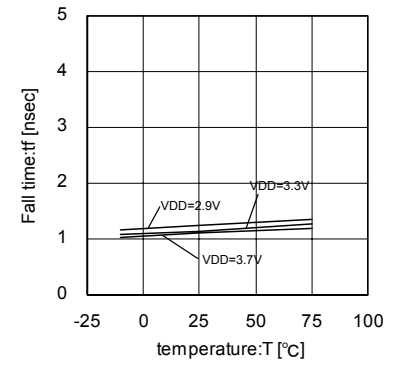

Fig. 46 36MHz
Fall-time temperature characteristics

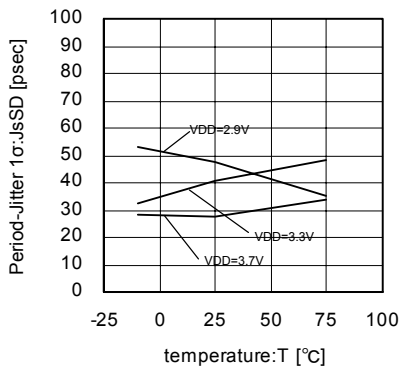

Fig. 47 36MHz
Period-Jitter 1 σ temperature characteristics

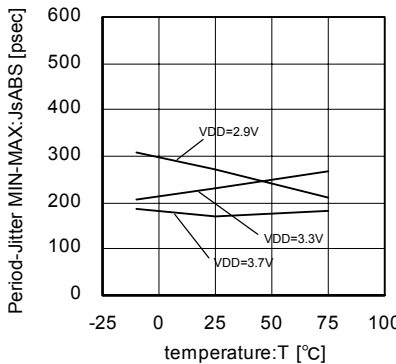

Fig. 48 36MHz
Jitter-MinMax temperature characteristics

● Reference data (BU3073HFV Temperature and Supply voltage variations data)

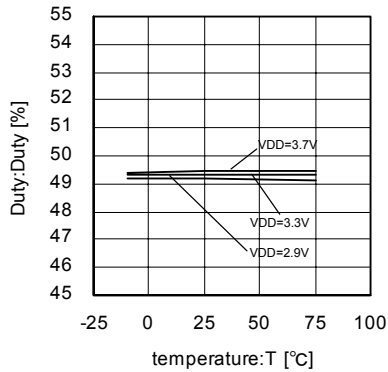

Fig.49 24.375MHz
Duty temperature characteristics

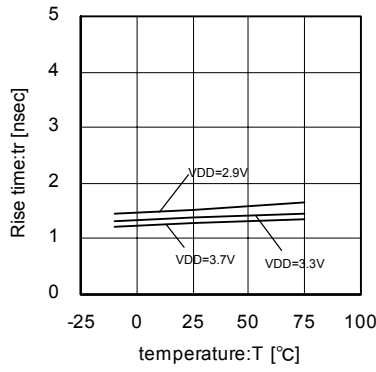

Fig.50 24.375MHz
Rise-time temperature characteristics

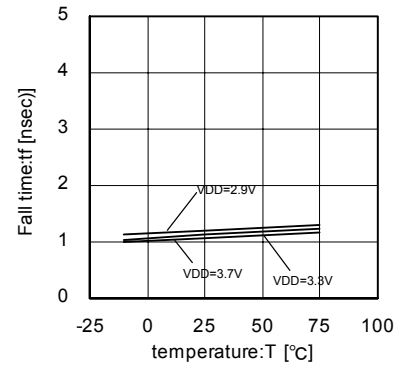

Fig.51 24.375MHz
Fall-time temperature characteristics

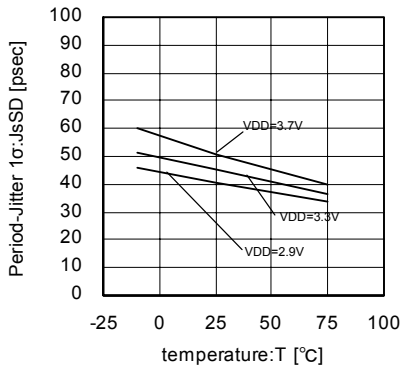

Fig.52 24.375MHz
Period-Jitter 1σ temperature characteristics

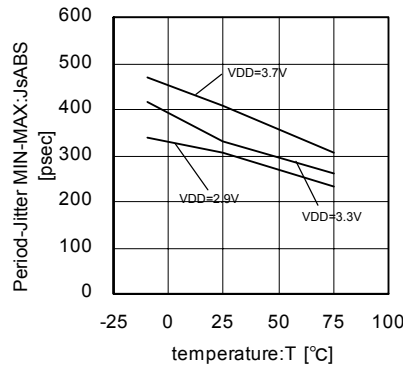

Fig.53 24.375MHz
Jitter-MinMax temperature characteristics

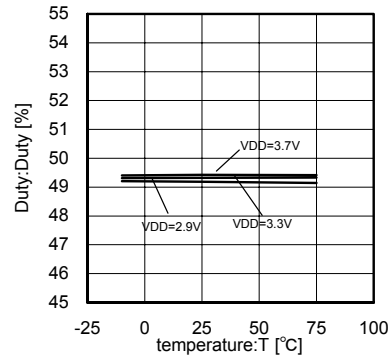

Fig.54 24.5454MHz
Duty temperature characteristics

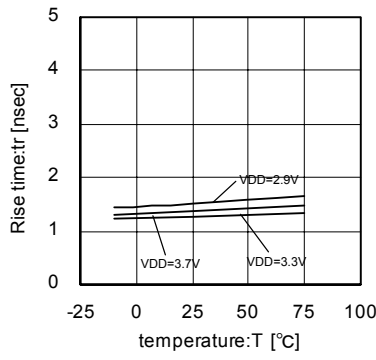

Fig.55 24.5454MHz
Rise-time temperature characteristics

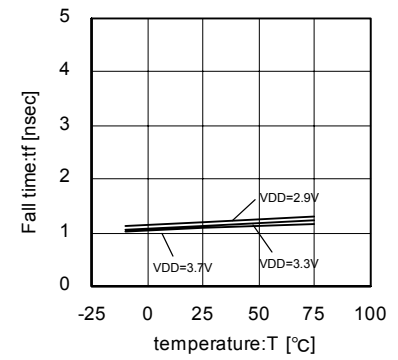

Fig.56 24.5454MHz
Fall-time temperature characteristics

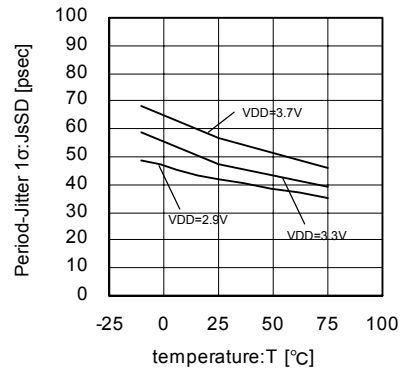

Fig.57 24.5454MHz
Period-Jitter 1σ temperature characteristics

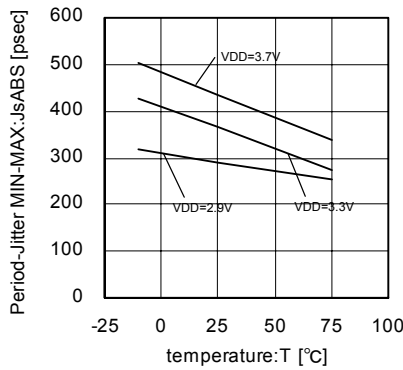
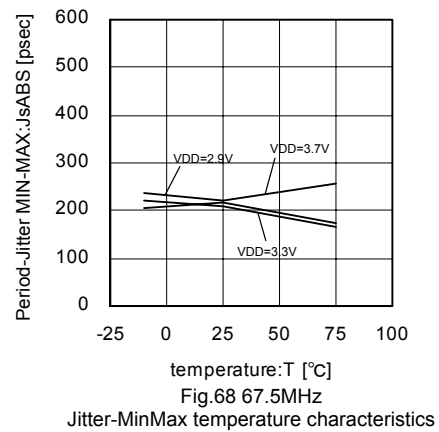
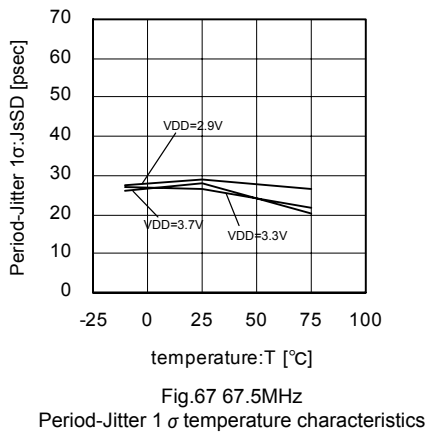
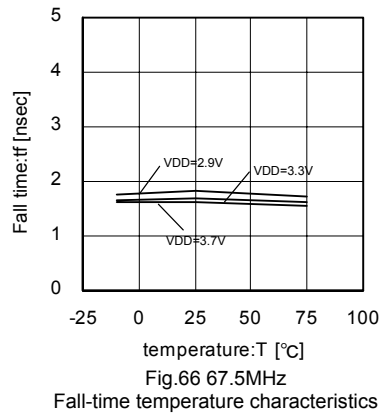
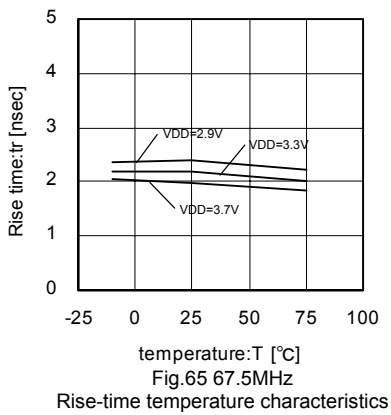
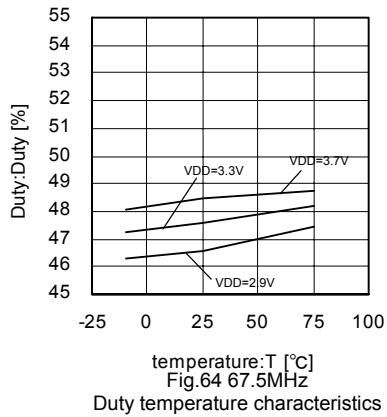
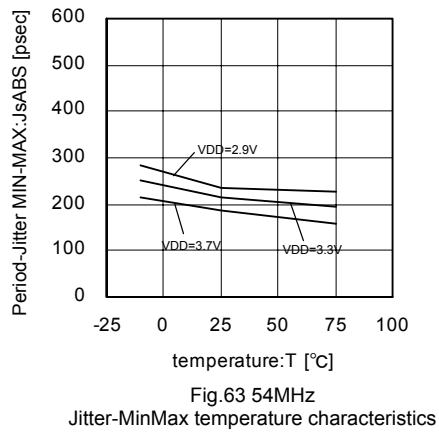
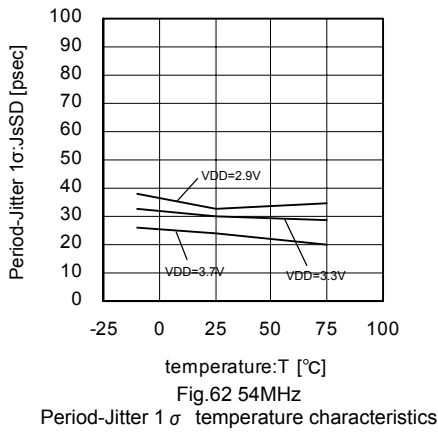
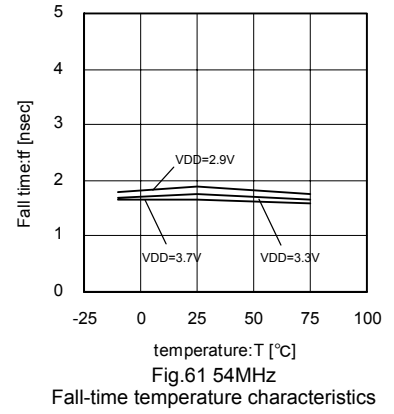
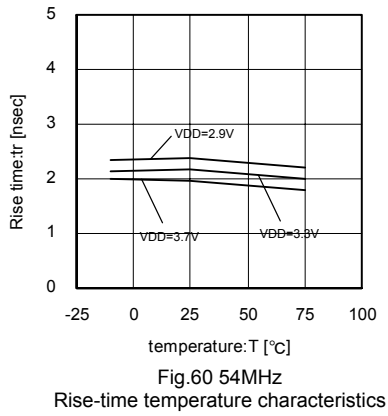
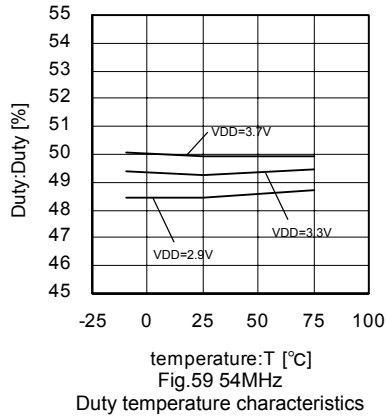

Fig.58 24.5454MHz
Jitter-MinMax temperature characteristics

●Reference data (BU3076HFV Temperature and Supply voltage variations data)



● Reference data (BU7322HFV Temperature and Supply voltage variations data)

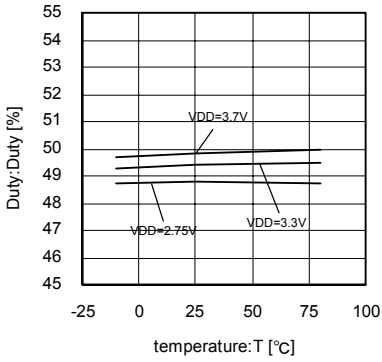

Fig.69 49.5MHz
Duty temperature characteristics

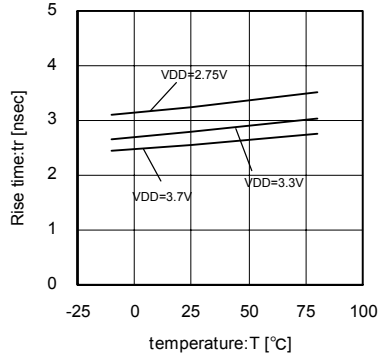

Fig.70 49.5MHz
Rise-time temperature characteristics

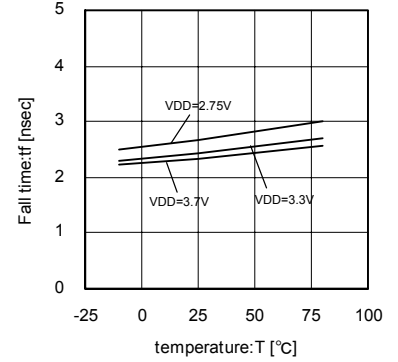

Fig.71 49.5MHz
Fall-time temperature characteristics

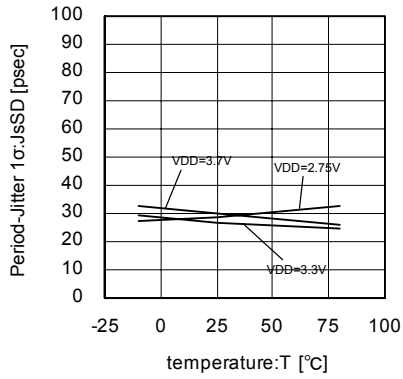

Fig.72 49.5MHz
Period-Jitter 1 σ temperature characteristics

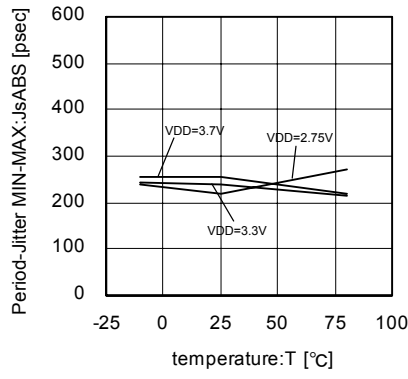

Fig.73 49.5MHz
Jitter-MinMax temperature characteristics

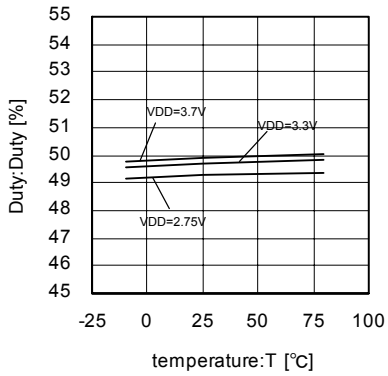

Fig.74 36MHz
Duty temperature characteristics

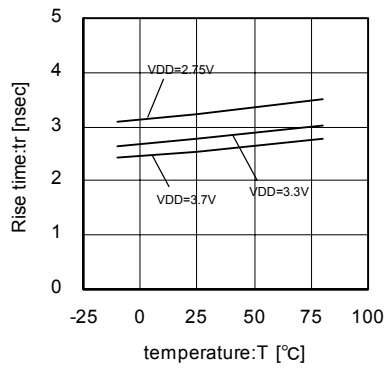

Fig.75 36MHz
Rise-time temperature characteristics

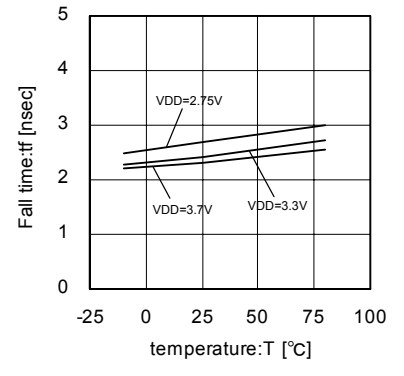

Fig.76 36MHz
Fall-time temperature characteristics

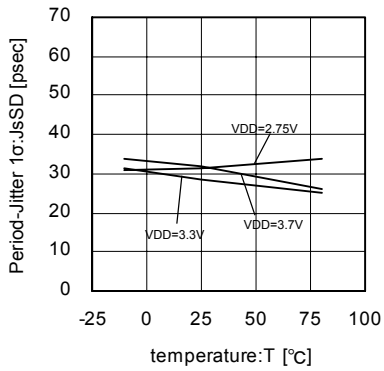

Fig.77 36MHz
Period-Jitter 1 σ temperature characteristics

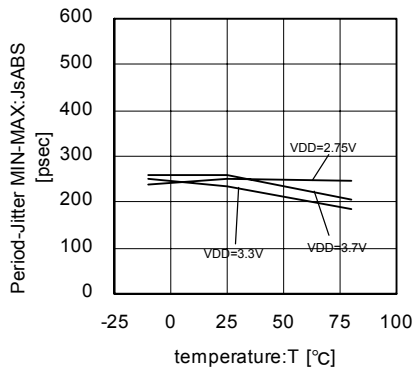

Fig.78 36MHz
Jitter-MinMax temperature characteristics

● Reference data (BU7325HFV Temperature and Supply voltage variations data)

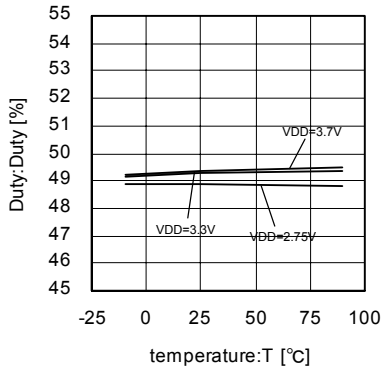

Fig.79 48MHz
Duty temperature characteristics

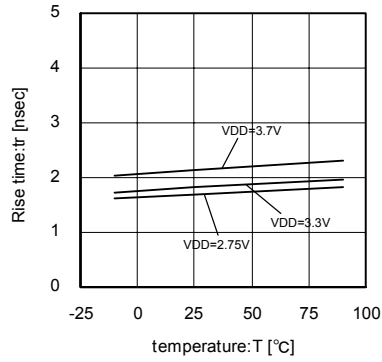

Fig.80 48MHz
Rise-time temperature characteristics

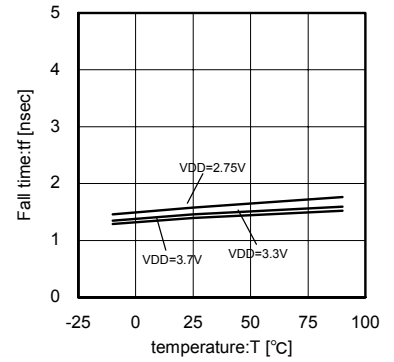

Fig.81 48MHz
Fall-time temperature characteristics

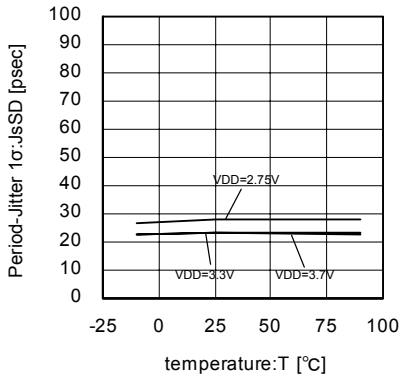

Fig.82 48MHz
Period-Jitter 1σ temperature characteristics

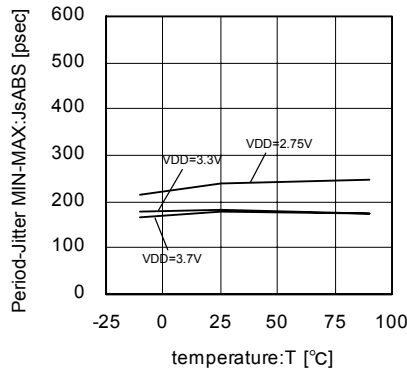

Fig.83 48MHz
Jitter-MinMax temperature characteristics

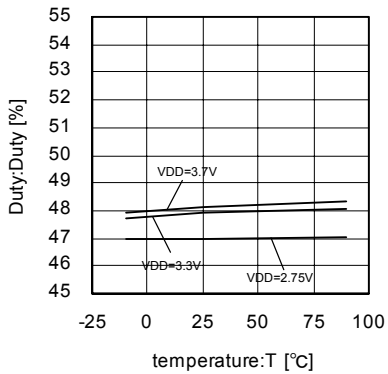

Fig.84 78MHz
Duty temperature characteristics

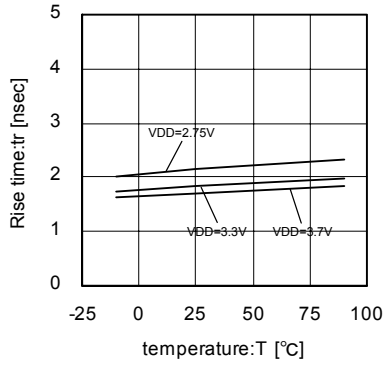

Fig.85 78MHz
Rise-time temperature characteristics

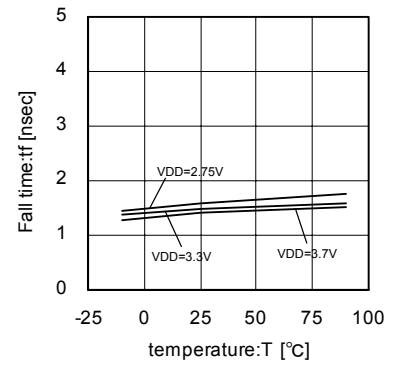

Fig.86 78MHz
Fall-time temperature characteristics

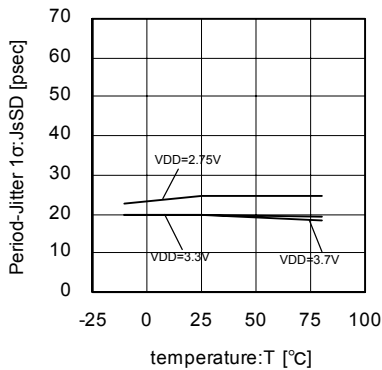

Fig.87 78MHz
Period-Jitter 1σ temperature characteristics

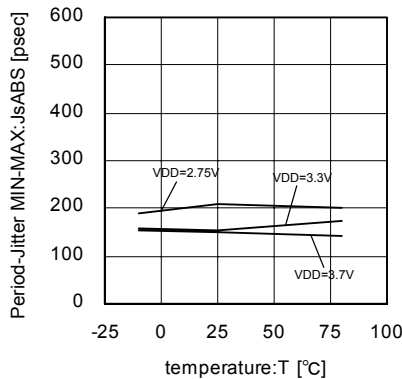

Fig.88 78MHz
Jitter-MinMax temperature characteristics

●Block diagram, pin assignment/functions

(BU3071HFV)

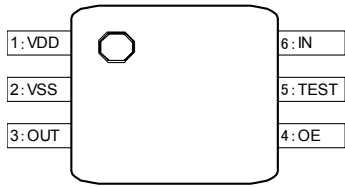

Fig.89

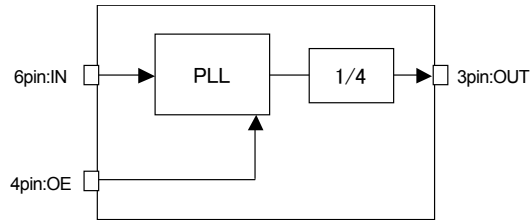

Fig.90

PIN NO.	PIN name	Function
1	VDD	Power supply
2	VSS	GND
3	OUT	Clock output terminal
4	OE	Output enable (L: disable, H: enable), equipped with Pull-down function, output fixed to L at disable
5	TEST	TEST pin, equipped with Pull-down function
6	IN	Clock input pin (28.6363 MHz input)

(BU3072HFV)

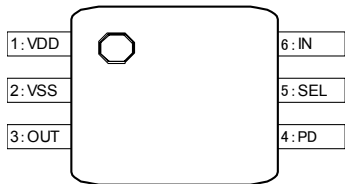

Fig.91

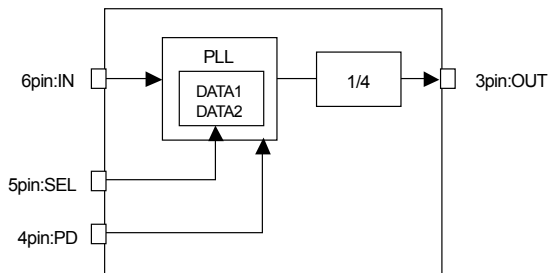

Fig.92

PIN NO.	PIN name	Function
1	VDD	Power supply
2	VSS	GND
3	OUT	Clock output terminal (L : 27.0000MHz, H : 36.0000MHz)
4	PD	Power-down (L: Hi-Z, H: enable), equipped with Pull-down function, output set to Hi-Z at disable
5	SEL	Output selection (L: 27.0000 MHz, H: 36.0000 MHz)
6	IN	Clock input pin (48.0000 MHz input)

(BU3073HFV)

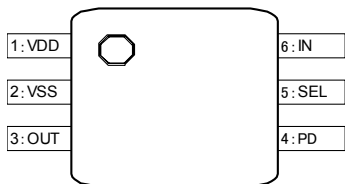

Fig.93

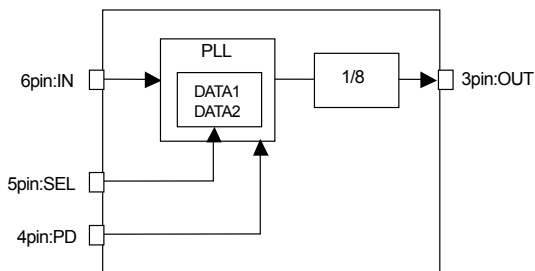

Fig.94

PIN NO.	PIN name	Function
1	VDD	Power supply
2	VSS	GND
3	OUT	Clock output terminal (L : 24.3750MHz, H : 24.5454MHz)
4	PD	Power-down (L: disable, H: enable), equipped with Pull-down function, output set to L at disable
5	SEL	Output selection (L : 24.3750MHz, H : 24.5454MHz)
6	IN	Clock input pin (48.0000MHz input)

(BU3076HFV)

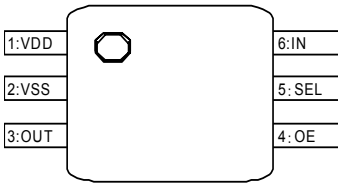

Fig.95

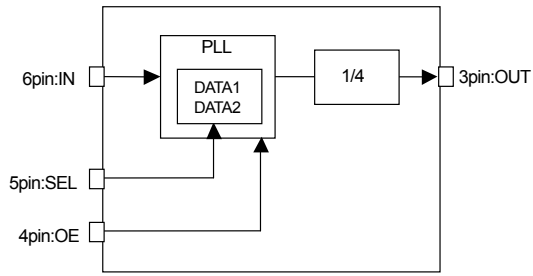

Fig.96

PIN NO.	PIN name	Function
1	VDD	Power supply
2	VSS	GND
3	OUT	Clock output terminal (L : 54.0000MHz, H : 67.5000MHz)
4	OE	Power-down (L: disable, H: enable), equipped with Pull-down function, output set to L at disable
5	SEL	Output selection (L : 54.0000MHz, H : 67.5000MHz)
6	IN	Clock input pin (27.0000MHz input)

(BU7322HFV)

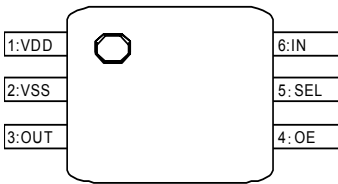

Fig.97

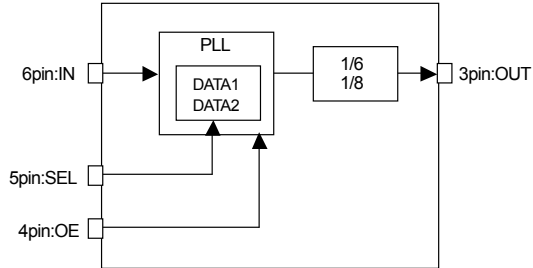

Fig.98

PIN NO.	PIN name	Function
1	VDD	Power supply
2	VSS	GND
3	OUT	Clock output terminal (L : 49.5000MHz, H : 36.0000MHz)
4	OE	Power-down (L : disable ,H : enable) equipped with Pull-down function, disable output set to L at disable
5	SEL	Output selection (L : 49.5000MHz, H : 36.0000MHz) equipped with Pull-down function
6	IN	Clock input pin (27.0000MHz input)

(BU7325HFV)

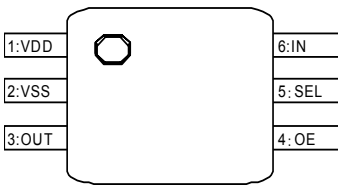

Fig.99

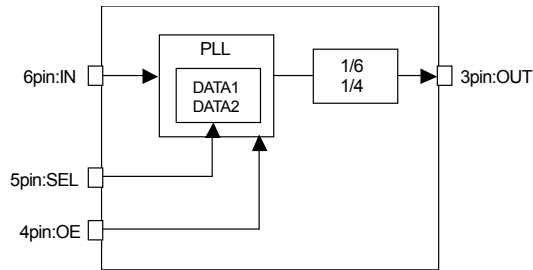

Fig.100

PIN NO.	PIN name	Function
1	VDD	Power supply
2	VSS	GND
3	OUT	Clock output terminal (L : 48.0000MHz, H : 78.0000MHz)
4	OE	Power-down (L : disable ,H : enable) equipped with Pull-down function, disable output set to L at disable
5	SEL	Output selection (L : 48.0000MHz, H : 78.0000MHz)
6	IN	Clock input pin (27.0000MHz input)

● Application circuit example

(BU3071HFV)

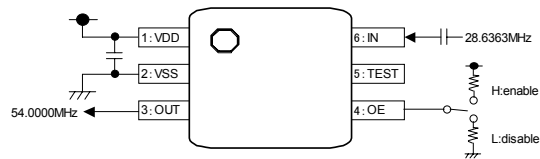

Fig.101

(BU3072HFV)

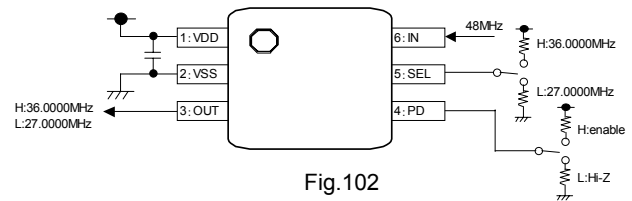

Fig.102

(BU3073HFV)

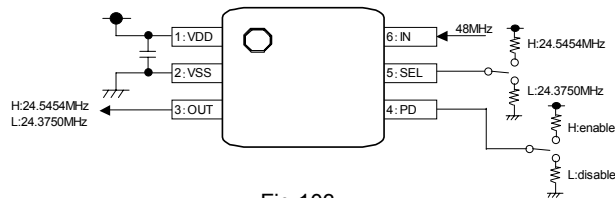

Fig.103

(BU3076HFV)

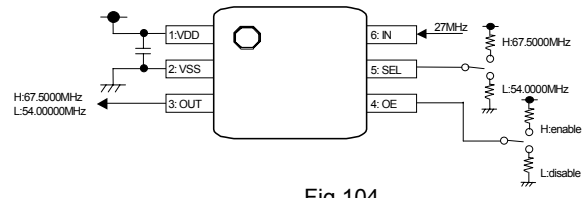

Fig.104

(BU7322HFV)

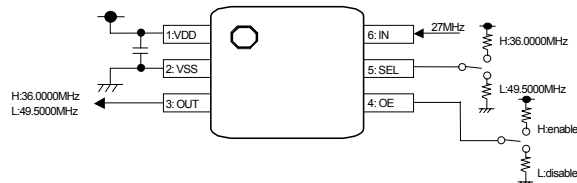

Fig.105

(BU7325HFV)

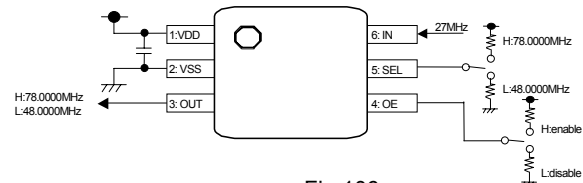

Fig.106

- * For VDD and VSS, insert a bypass capacitor of approx. 0.1 μ F as close as possible to the pin.
- * Bypass capacitors with good high-frequency characteristics are recommended.
- * Even though we believe that the typical application circuit is worth of a recommendation, please be sure to thoroughly recheck the characteristics before use.

●Equivalent circuit

3-pin (Output pin)

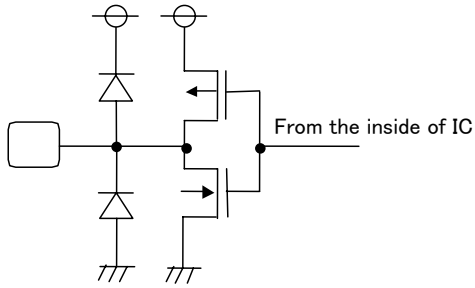

Fig.107

BU3071HFV, BU3073HFV, BU3076HFV
BU7322HFV, BU7325HFV

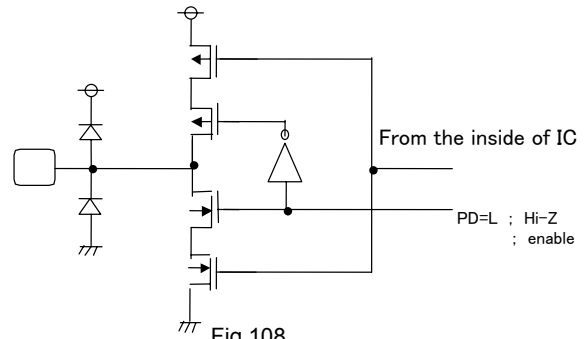

Fig.108

BU3072HFV

4-pin (Input pin)

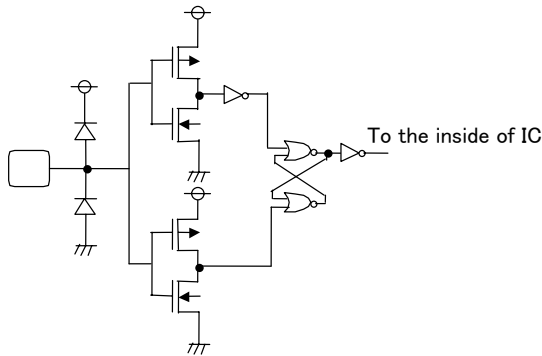

Fig.109

5-pin (Input pin)

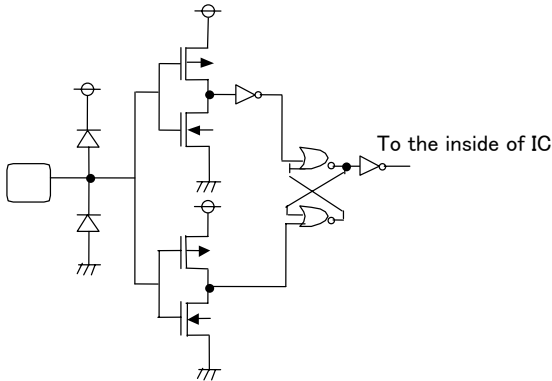

Fig.110

BU3072HFV, BU3073HFV, BU3076HFV
BU7322HFV, BU7325HFV

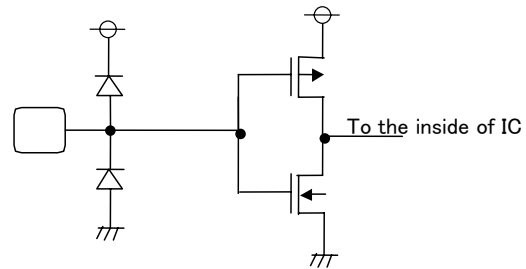

Fig.111

BU3071HFV

6-pin (Input pin)

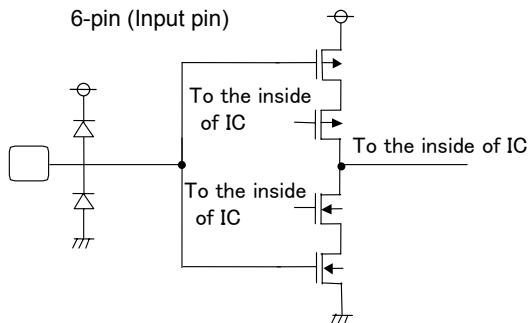

Fig.112

BU3072HFV, BU3073HFV, BU3076HFV
BU7322HFV, BU7325HFV

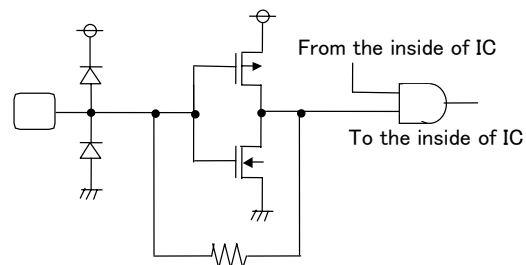

Fig.113

BU3071HFV

● Appearance of Marker

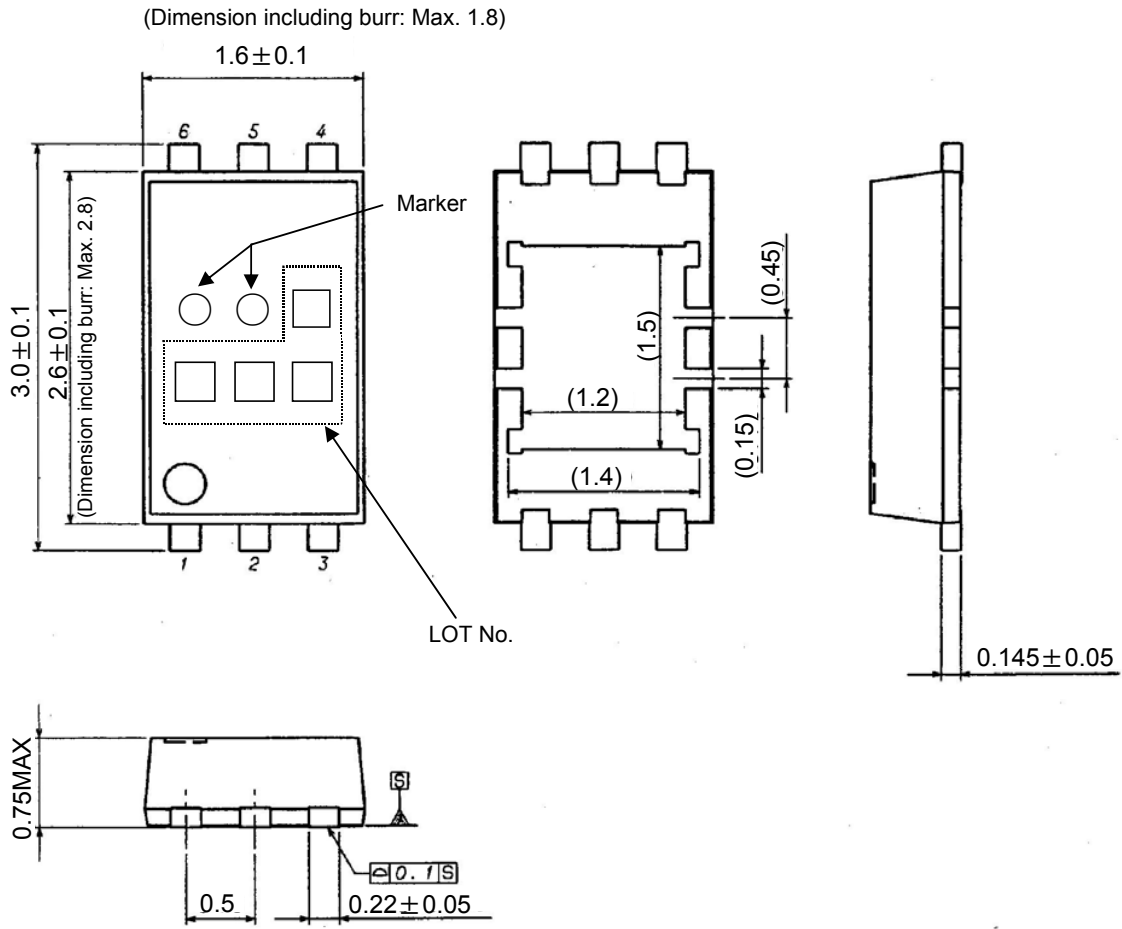

Fig.114

(UNIT : mm)

• List of markers

Model name	Marker
BU3071HFV	AB
BU3072HFV	AC
BU3073HFV	AD
BU3076HFV	AA
BU7322HFV	AE
BU7325HFV	AH

●Cautions on use

(1) Absolute Maximum Ratings

An excess in the absolute maximum ratings, such as applied voltage (VDD or VIN), operating temperature range (Topr), etc., can break down devices, thus making impossible to identify breaking mode such as a short circuit or an open circuit. If any special mode exceeding the absolute maximum ratings is assumed, consideration should be given to take physical safety measures including the use of fuses, etc.

(2) Recommended operating conditions

These conditions represent a range within which characteristics can be provided approximately as expected. The electrical characteristics are guaranteed under the conditions of each parameter.

(3) Reverse connection of power supply connector

The reverse connection of power supply connector can break down ICs. Take protective measures against the breakdown due to the reverse connection, such as mounting an external diode between the power supply and the IC's power supply terminal.

(4) Power supply line

Design PCB pattern to provide low impedance for the wiring between the power supply and the GND lines.

In this regard, for the digital block power supply and the analog block power supply, even though these power supplies has the same level of potential, separate the power supply pattern for the digital block from that for the analog block, thus suppressing the diffraction of digital noises to the analog block power supply resulting from impedance common to the wiring patterns. For the GND line, give consideration to design the patterns in a similar manner.

Furthermore, for all power supply terminals to ICs, mount a capacitor between the power supply and the GND terminal. At the same time, in order to use an electrolytic capacitor, thoroughly check to be sure the characteristics of the capacitor to be used present no problem including the occurrence of capacity dropout at a low temperature, thus determining the constant.

(5) GND voltage

Make setting of the potential of the GND terminal so that it will be maintained at the minimum in any operating state. Furthermore, check to be sure no terminals are at a potential lower than the GND voltage including an actual electric transient.

(6) Short circuit between terminals and erroneous mounting

In order to mount ICs on a set PCB, pay thorough attention to the direction and offset of the ICs. Erroneous mounting can break down the ICs. Furthermore, if a short circuit occurs due to foreign matters entering between terminals or between the terminal and the power supply or the GND terminal, the ICs can break down.

(7) Operation in strong electromagnetic field

Be noted that using ICs in the strong electromagnetic field can malfunction them.

(8) Inspection with set PCB

On the inspection with the set PCB, if a capacitor is connected to a low-impedance IC terminal, the IC can suffer stress. Therefore, be sure to discharge from the set PCB by each process. Furthermore, in order to mount or dismount the set PCB to/from the jig for the inspection process, be sure to turn OFF the power supply and then mount the set PCB to the jig. After the completion of the inspection, be sure to turn OFF the power supply and then dismount it from the jig. In addition, for protection against static electricity, establish a ground for the assembly process and pay thorough attention to the transportation and the storage of the set PCB.

(9) Input terminals

In terms of the construction of IC, parasitic elements are inevitably formed in relation to potential. The operation of the parasitic element can cause interference with circuit operation, thus resulting in a malfunction and then breakdown of the input terminal. Therefore, pay thorough attention not to handle the input terminals, such as to apply to the input terminals a voltage lower than the GND respectively, so that any parasitic element will operate. Furthermore, do not apply a voltage to the input terminals when no power supply voltage is applied to the IC. In addition, even if the power supply voltage is applied, apply to the input terminals a voltage lower than the power supply voltage or within the guaranteed value of electrical characteristics.

(10) Ground wiring pattern

If small-signal GND and large-current GND are provided, It will be recommended to separate the large-current GND pattern from the small-signal GND pattern and establish a single ground at the reference point of the set PCB so that resistance to the wiring pattern and voltage fluctuations due to a large current will cause no fluctuations in voltages of the small-signal GND. Pay attention not to cause fluctuations in the GND wiring pattern of external parts as well.

(11) External capacitor

In order to use a ceramic capacitor as the external capacitor, determine the constant with consideration given to a degradation in the nominal capacitance due to DC bias and changes in the capacitance due to temperature, etc.

● Product Designation

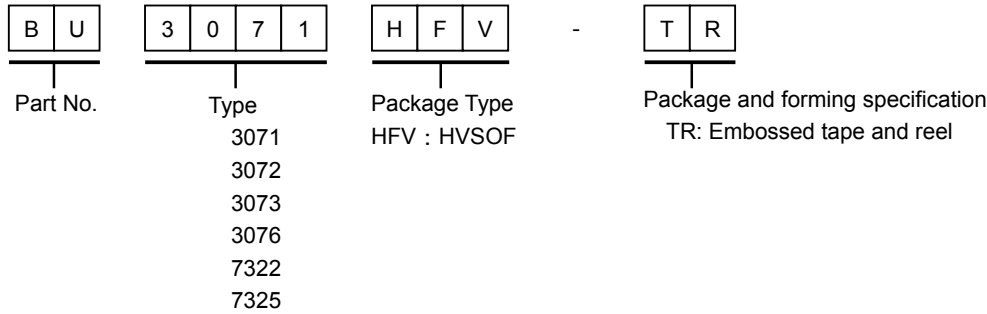

HVSO6

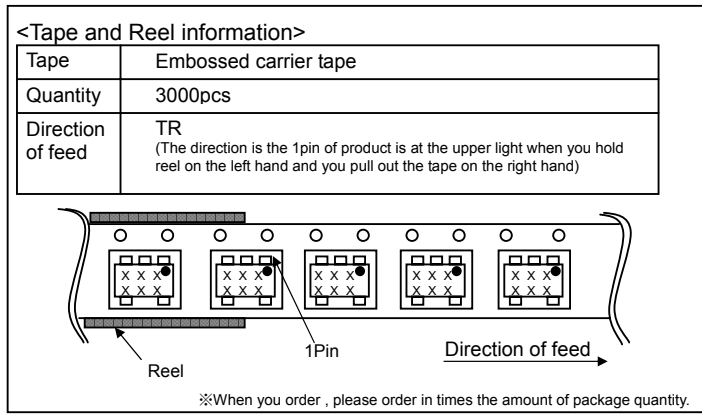
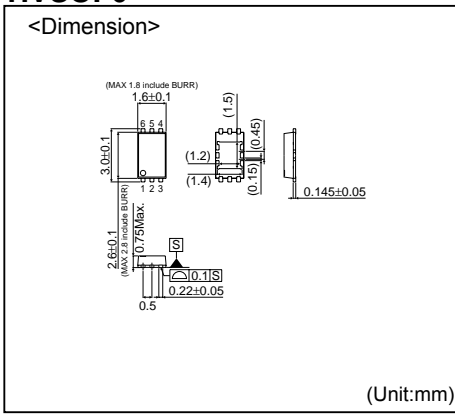

- The contents described herein are correct as of June, 2007
- The contents described herein are subject to change without notice. For updates of the latest information, please contact and confirm with ROHM CO.,LTD.
- Any part of this application note must not be duplicated or copied without our permission.
- Application circuit diagrams and circuit constants contained herein are shown as examples of standard use and operation. Please pay careful attention to the peripheral conditions when designing circuits and deciding upon circuit constants in the set.
- Any data, including, but not limited to application circuit diagrams and information, described herein are intended only as illustrations of such devices and not as the specifications for such devices. ROHM CO.,LTD. disclaims any warranty that any use of such devices shall be free from infringement of any third party's intellectual property rights or other proprietary rights, and further, assumes no liability of whatsoever nature in the event of any such infringement, or arising from or connected with or related to the use of such devices.
- Upon the sale of any such devices, other than for buyer's right to use such devices itself, resale or otherwise dispose of the same, implied right or license to practice or commercially exploit any intellectual property rights or other proprietary rights owned or controlled by ROHM CO., LTD. is granted to any such buyer.
- The products described herein utilize silicon as the main material.
- The products described herein are not designed to be X ray proof.

The products listed in this catalog are designed to be used with ordinary electronic equipment or devices (such as audio visual equipment, office-automation equipment, communications devices, electrical appliances and electronic toys). Should you intend to use these products with equipment or devices which require an extremely high level of reliability and the malfunction of which would directly endanger human life (such as medical instruments, transportation equipment, aerospace machinery, nuclear-reactor controllers, fuel controllers and other safety devices), please be sure to consult with our sales representative in advance.

Excellence in Electronics

ROHM CO., LTD.

21, Saiin Mizosaki-cho, Ukyo-ku, Kyoto
615-8585, Japan
TEL: +81-75-311-2121 FAX: +81-75-315-0172
URL: <http://www.rohm.com>

Published by
LSI Business Promotion Dept.

Contact us for further information about the products.

Seoul TEL: +82-2-8182-700	FAX: +82-2-8182-715	Bangkok TEL: +66-2-254-4890	FAX: +66-2-256-6334
Masan TEL: +82-55-240-6234	FAX: +82-55-240-6236	Kuala Lumpur TEL: +60-3-7958-8355	FAX: +60-3-7958-8377
Dalian TEL: +86-411-8230-8549	FAX: +86-411-8230-8537	Penang TEL: +60-4-6585084	FAX: +60-4-6585167
Beijing TEL: +86-10-8525-2483	FAX: +86-10-8525-2489	Dusseldorf TEL: +49-2145-9210	FAX: +49-2154-921400
Tianjin TEL: +86-22-23029181	FAX: +86-22-23029183	Munich TEL: +49-8161-48310	FAX: +49-8161-483120
Shanghai TEL: +86-21-6279-2727	FAX: +86-21-6247-2066	Stuttgart TEL: +49-711-72723710	FAX: +49-711-72723720
Hangzhou TEL: +86-571-87658072	FAX: +86-571-87658071	France TEL: +33-1-5697-3060	FAX: +33-1-5697-3080
Nanjing TEL: +86-25-8689-0015	FAX: +86-25-8689-0393	United Kingdom TEL: +44-1-908-306700	FAX: +44-1-908-235788
Ningbo TEL: +86-574-87654201	FAX: +86-574-87654208	Denmark TEL: +45-3694-4739	FAX: +45-3694-4789
Qingdao TEL: +86-532-5779-312	FAX: +86-532-5779-653	Barcelona TEL: +34-9375-24320	FAX: +34-9375-24410
Suzhou TEL: +86-512-6807-1300	FAX: +86-512-6807-2300	Malaga TEL: +34-9520-20263	FAX: +34-9520-20023
Tianjin TEL: +86-22-23029181	FAX: +86-22-23029183	Hungary TEL: +36-1-4719338	FAX: +36-1-4719339
Wuxi TEL: +86-510-82702693	FAX: +86-510-82702992	Poland TEL: +48-22-5757213	FAX: +48-22-5757001
Hong Kong TEL: +852-2-740-6262	FAX: +852-2-375-8971	Russia TEL: +7-95-980-6755	FAX: +7-95-937-8290
Dongguan TEL: +86-769-393-3320	FAX: +86-769-398-4140	San Diego TEL: +1-858-625-3630	FAX: +1-858-625-3670
Fuzhou TEL: +86-591-8801-8698	FAX: +86-591-8801-8690	Atlanta TEL: +1-770-754-5972	FAX: +1-770-754-0691
Guangzhou TEL: +86-20-8364-9796	FAX: +86-20-8364-9707	Boston TEL: +1-978-371-0382	FAX: +1-928-438-7164
Shenzhen TEL: +86-755-8307-3001	FAX: +86-755-8307-3003	Chicago TEL: +1-847-368-1006	FAX: +1-847-368-1008
Xiamen TEL: +86-592-239-8382	FAX: +86-592-239-8380	Dallas TEL: +1-972-312-8818	FAX: +1-972-312-0330
Zhuhai TEL: +86-756-3232-4860	FAX: +86-756-3232-460	Denver TEL: +1-303-708-0908	FAX: +1-303-708-0858
Taipei TEL: +866-2-2500-6956	FAX: +866-2-2503-2869	Nashville TEL: +1-615-620-6700	FAX: +1-615-620-6702
Kaohsiung TEL: +886-7-237-0881	FAX: +886-7-238-7332	Guadalajara TEL: +52-33-3123-2001	FAX: +52-33-3123-2002
Singapore TEL: +65-6332-2322	FAX: +65-6332-5662		
Manila TEL: +63-2-807-6872	FAX: +63-2-809-1422		

Catalog No.07T170A '07.6 ROHM © 1000 NZ

Notes

- No technical content pages of this document may be reproduced in any form or transmitted by any means without prior permission of ROHM CO.,LTD.
- The contents described herein are subject to change without notice. The specifications for the product described in this document are for reference only. Upon actual use, therefore, please request that specifications to be separately delivered.
- Application circuit diagrams and circuit constants contained herein are shown as examples of standard use and operation. Please pay careful attention to the peripheral conditions when designing circuits and deciding upon circuit constants in the set.
- Any data, including, but not limited to application circuit diagrams information, described herein are intended only as illustrations of such devices and not as the specifications for such devices. ROHM CO.,LTD. disclaims any warranty that any use of such devices shall be free from infringement of any third party's intellectual property rights or other proprietary rights, and further, assumes no liability of whatsoever nature in the event of any such infringement, or arising from or connected with or related to the use of such devices.
- Upon the sale of any such devices, other than for buyer's right to use such devices itself, resell or otherwise dispose of the same, no express or implied right or license to practice or commercially exploit any intellectual property rights or other proprietary rights owned or controlled by
- ROHM CO., LTD. is granted to any such buyer.
- Products listed in this document are no antiradiation design.

The products listed in this document are designed to be used with ordinary electronic equipment or devices (such as audio visual equipment, office-automation equipment, communications devices, electrical appliances and electronic toys).

Should you intend to use these products with equipment or devices which require an extremely high level of reliability and the malfunction of which would directly endanger human life (such as medical instruments, transportation equipment, aerospace machinery, nuclear-reactor controllers, fuel controllers and other safety devices), please be sure to consult with our sales representative in advance.

It is our top priority to supply products with the utmost quality and reliability. However, there is always a chance of failure due to unexpected factors. Therefore, please take into account the derating characteristics and allow for sufficient safety features, such as extra margin, anti-flammability, and fail-safe measures when designing in order to prevent possible accidents that may result in bodily harm or fire caused by component failure. ROHM cannot be held responsible for any damages arising from the use of the products under conditions out of the range of the specifications or due to non-compliance with the NOTES specified in this catalog.

Thank you for your accessing to ROHM product informations.

More detail product informations and catalogs are available, please contact your nearest sales office.

ROHM Customer Support System

THE AMERICAS / EUROPE / ASIA / JAPAN

www.rohm.com

Contact us : webmaster@rohm.co.jp