

COBP PHOTO REFLECTOR

■ GENERAL DESCRIPTION

NJL5901AR-1 is the compact surface mount type photo reflector, which miniaturized outside dimension compared with the current COBP reflector, NJL5901AR. Compared with the NJL5901AR, the mounting area of NJL5901AR-1 is reduced to 54%. Moreover, the output current is 400 μ A typ. and is raised 180% compared with the NJL5901AR.

■ FEATURES

- Miniature, thin package : 1.3mm \times 1.6mm \times 0.6mm
- High output : 400 μ A typ.
- Pb free solder re-flowing permitted : 260°C, 2times
- Built-in visible light cut-off filter

■ APPLICATIONS

- Detecting the location of Lens unit for Cellular Phone's camera module
- Detecting the location of CD/DVD optical pickup head
- Detecting the rotation of various motors
- Paper edge detection and mechanism timing detection of facsimile, copy machine etc

■ OUTLINE (typ.)

Unit : mm

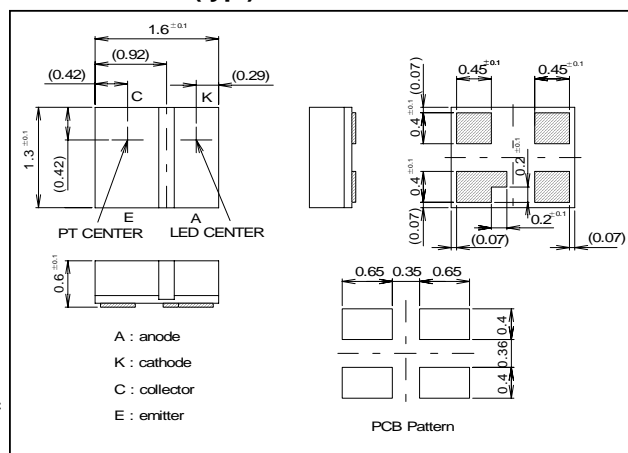

■ ABSOLUTE MAXIMUM RATINGS (Ta=25°C)

PARAMETER	SYMBOL	RATINGS	UNIT
Emitter			
Forward Current (Continuous)	IF	30	mA
Reverse Voltage (Continuous)	VR	6	V
Power Dissipation	PD	45	mW
Detector			
Collector-Emitter Voltage	VCEO	16	V
Emitter-Collector Voltage	VECO	6	V
Collector Current	IC	10	mA
Collector Power Dissipation	PC	25	mW
Coupled			
Total Power Dissipation	Ptot	60	mW
Operating Temperature	Topr	-30 to +85	°C
Storage Temperature	Tstg	-40 to +85	°C
Reflow Soldering Temperature	Tsol	260	°C

■ ELECTRO-OPTICAL CHARACTERISTICS (Ta=25°C)

PARAMETER	SYMBOL	TEST CONDITION	MIN	TYP	MAX	UNIT
Emitter						
Forward Voltage	VF	IF=4mA	0.9	—	1.3	V
Reverse Current	IR	VR=6V	—	—	10	μ A
Capacitance	Ct	VR=0V, f=1MHz	—	25	—	pF
Detector						
Dark Current	ICEO	VCE=10V	—	—	0.2	μ A
Collector-Emitter Voltage	VCEO	IC=100 μ A	16	—	—	V
Coupled						
Output Current	IO	IF=4mA, VCE=2V, d=0.7mm	280	—	700	μ A
Operating Dark Current *1	ICEOD	IF=4mA, VCE=2V	—	—	5	μ A
Rise Time	tr	IO=100 μ A, VCE=2V, RL=1K Ω , d=0.7mm	—	30	—	μ s
Fall Time	tf	IO=100 μ A, VCE=2V, RL=1K Ω , d=0.7mm	—	30	—	μ s

*1 Icoed may increase according to the periphery situation of the surface mounted product.

■ OUTPUT CURRENT TEST CONDITION

The infrared signal from LED is reflected at the aluminum surface

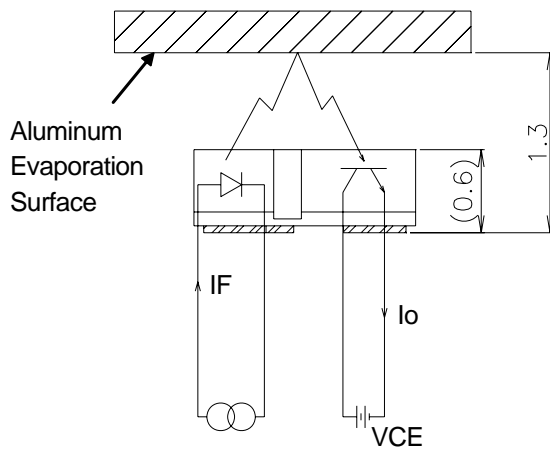

■ DARK CURRENT TEST CONDITION

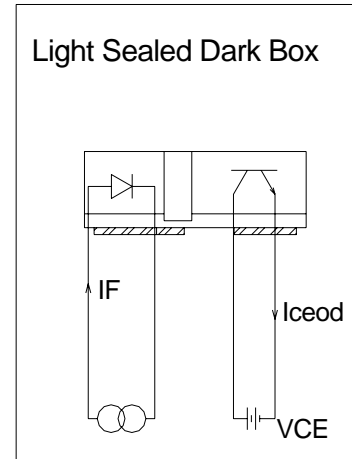

■ RESPONSE TIME TEST CONDITION

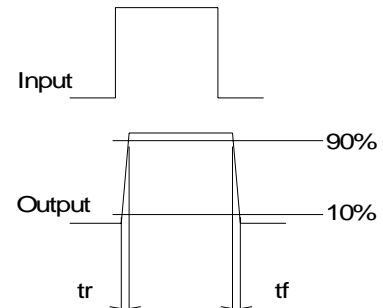
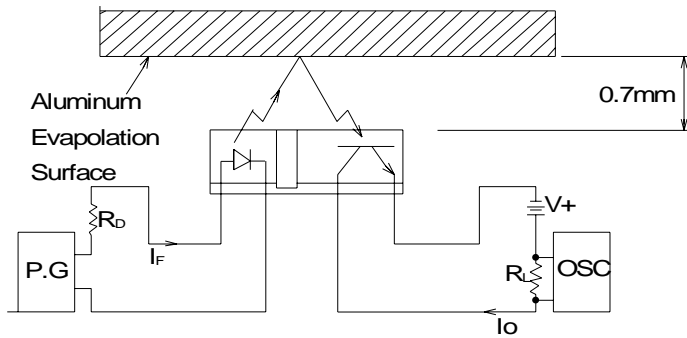

■ EDGE RESPONSE TEST CONDITION

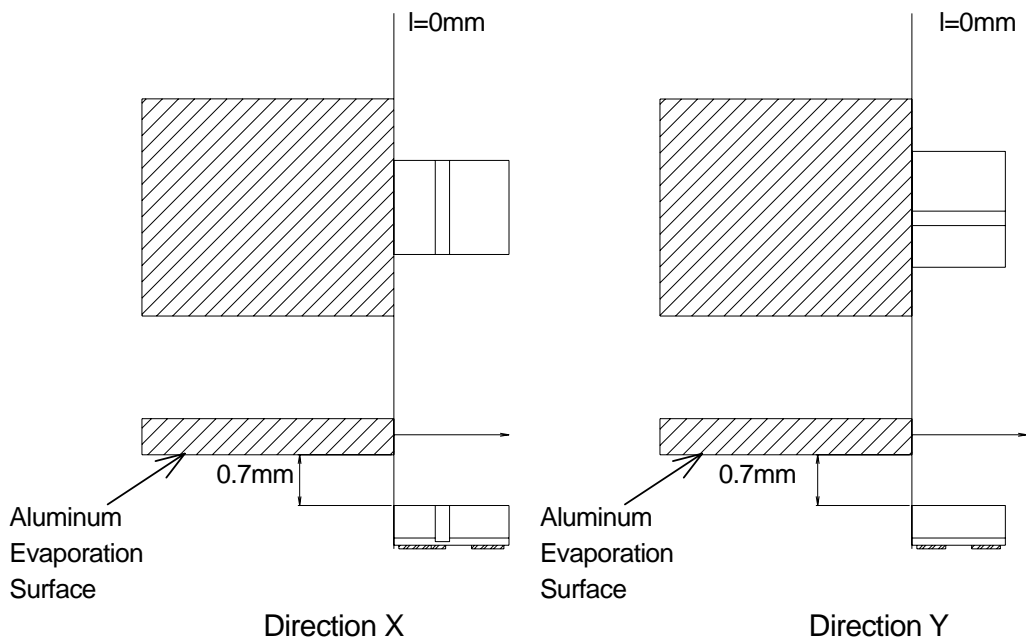

Power Dissipation vs. Temperature

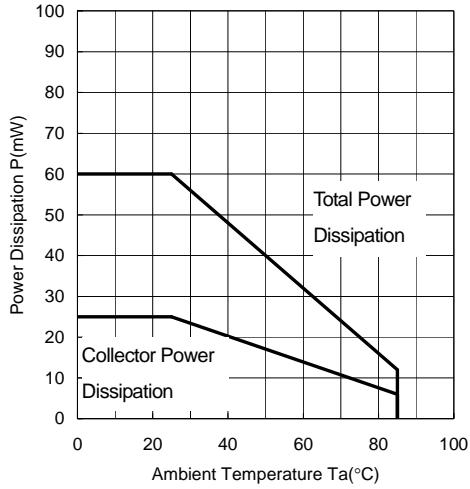

Forward Current vs. Temperature

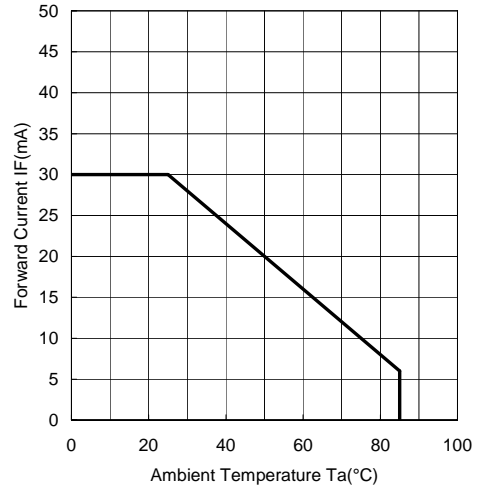

■ TYPICAL CHARACTERISTICS

Forward Voltage vs. Forward Current

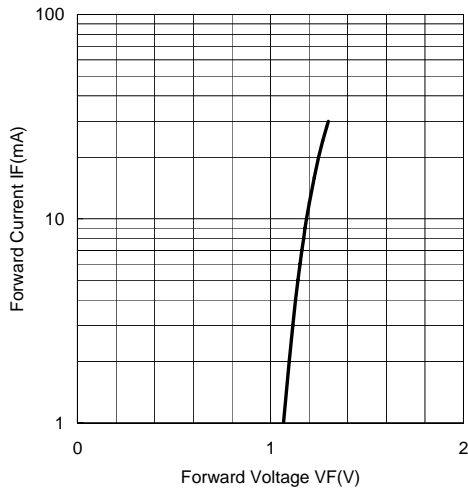

Forward Voltage vs. Temperature

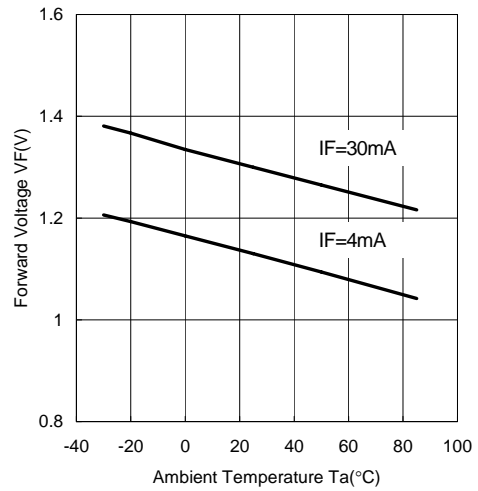

Dark Current vs. Temperature

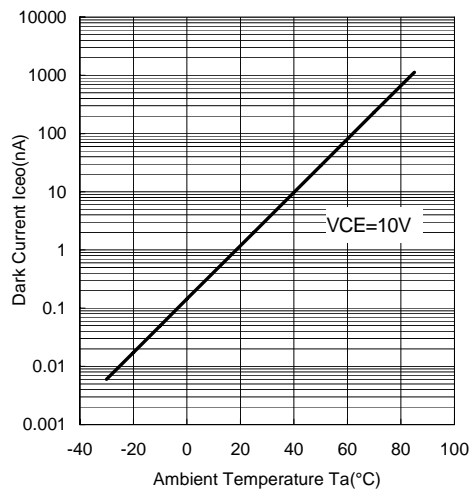

Operating Dark Current vs. Temperature

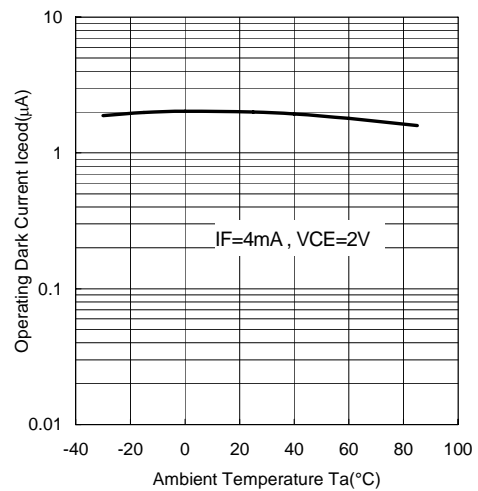

Output Current vs. Forward Current
($T_a=25^\circ\text{C}$)

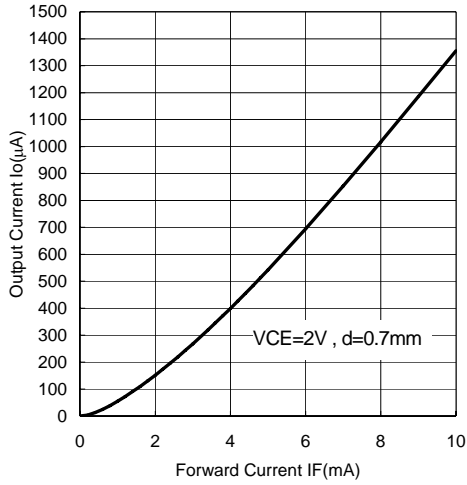

Output Current vs. Temperature

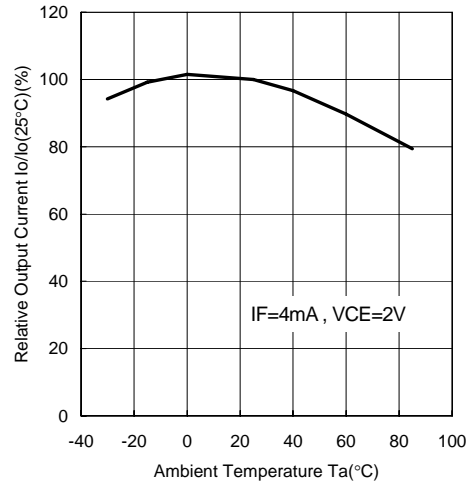

Output Characteristics ($T_a=25^\circ\text{C}$)

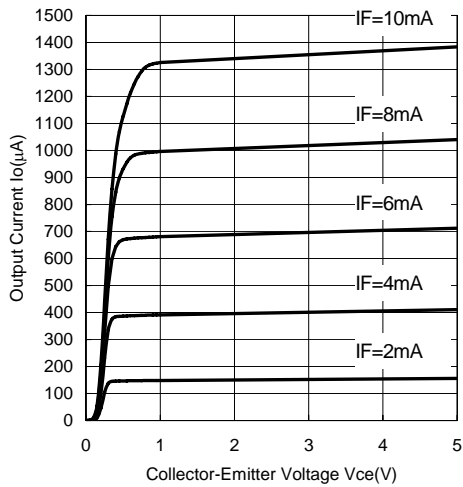

Vce Saturation ($T_a=25^\circ\text{C}$)

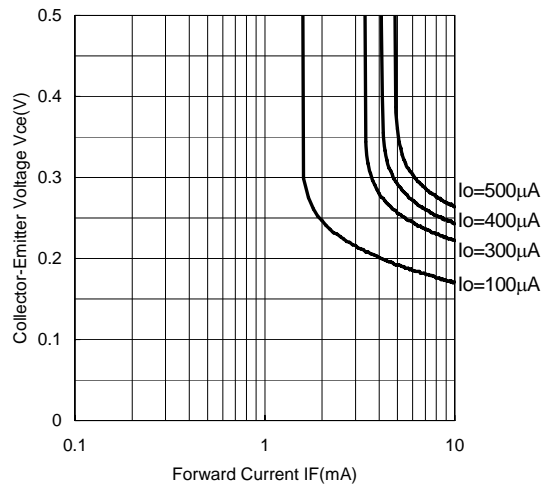

Output Current vs. Distance ($T_a=25^\circ\text{C}$)

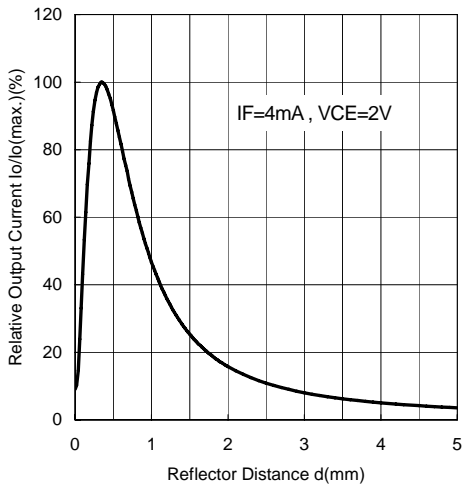

Output Current vs. Edge Distance ($T_a=25^\circ\text{C}$)

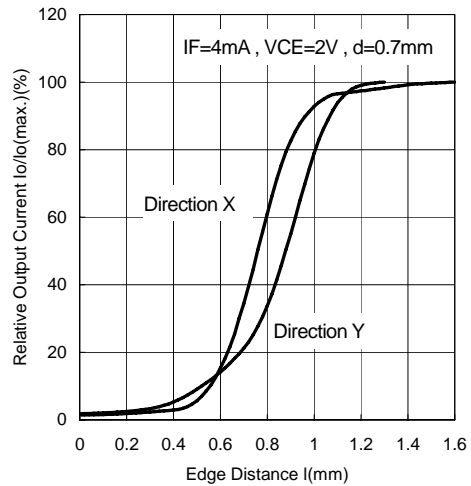

Spectral Response (Ta=25°C)

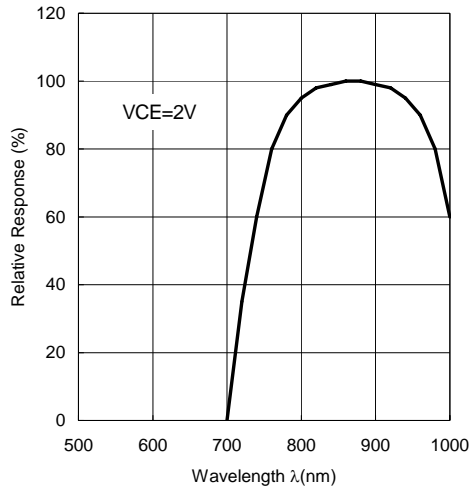

Switching Time vs. Load Resistance (Ta=25°C)

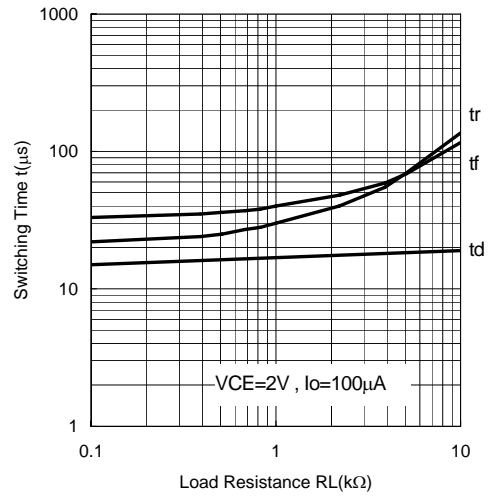

PRECAUTION FOR HANDLING

1. Soldering to actual circuit board

Soldering condition

The surface temperature of plastic package is lower than 260 °C.

Soldering Method

1) Reflow Method

Soldering to be done within twice under the recommended condition mentioned below

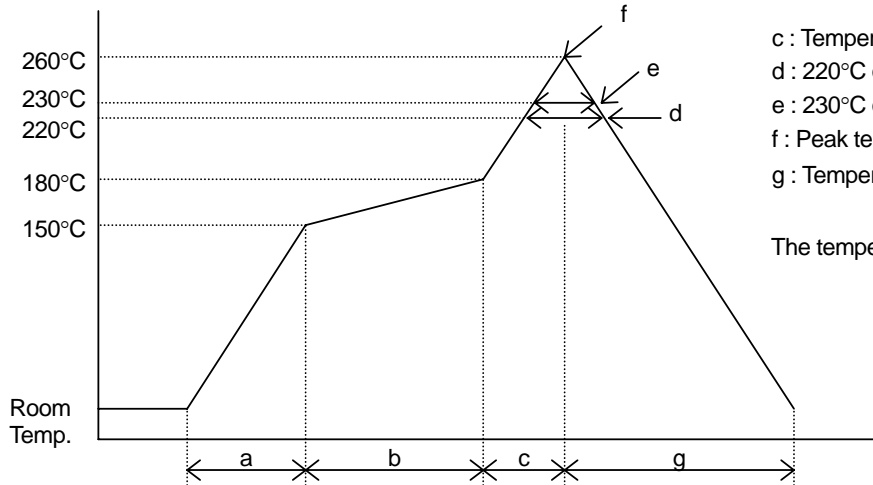

a : Temperature ramping rate	: 1 to 4°C/s
b : Pre-heating temperature	: 150 to 180°C
time	: 60 to 120s
c : Temperature ramping rate	: 1 to 4°C/s
d : 220°C or higher time	: Shorter than 60s
e : 230°C or higher time	: Shorter than 40s
f : Peak temperature	: Lower than 260°C
g : Temperature ramping rate	: 1 to 6°C/s

The temperature of the surface of mold package

2) Reflow Method (In case of infrared heating)

The temperature profile is same as the above

Avoid direct irradiation to the plastic package because it may absorb the Infrared Radiation and its surface temperature will be higher than the lead.

3) The other method

Avoid rapid heating up like dipping the devices directly into the melting solder or vapor phase method (VPS).

Solder the device in short time as soon as possible.

If the device is heated and kept in high temperature for longer time, its reliability would be affected.

2. Cleaning

Avoid washing the device after soldering by reflow method.

3. Attention in handling

- 1) Treat not to touch the lens surface.
- 2) Avoid dust and any other foreign materials on the lens surface such as paint, bonding material, etc.
- 3) Never to apply reverse voltage (V_{EC}) of more than 6V on the photo transistor when measuring the characteristics or adjusting the system. If applied, it causes to lower the sensitivity.
- 4) When mounting, special care has to be taken on the mounting position and tilting of the device because it is very important to place the device to the optimum position to the object.

4. Storage

Mount the device as soon as possible after opening the envelope. In order to prevent from degradation by the moisture at the reflow process, the device is contained in deaeration packaging.

1. Taping Size

- 1) Carrier tape is used with Polycarbonate.
- 2) Cover tape is used with electro statically prevention treated Polyester type tape.
- 3) Product taping direction is to place the index mark against the pull out direction of the tape as in the drawing.

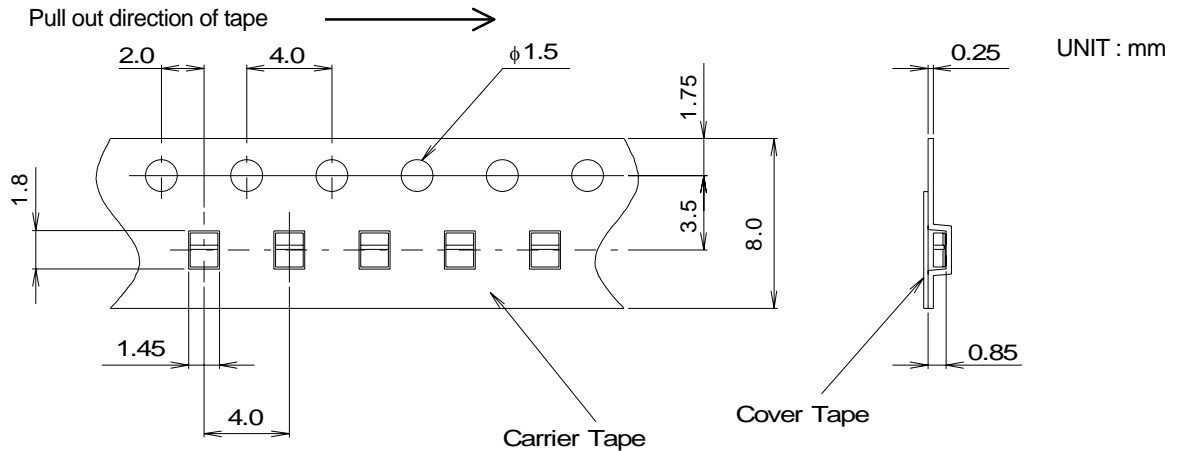

2. Taping Strength

Pull up the cover tape from the carrier tape, and when the opening angle comes around 10 to 15°, and the peeling-off strength is to be within the power of 20 to 70g.

3. Packaging

- 1) The taped products are to be rolled up on the taping reel as on the drawing.
- 2) Rolling up specification
 - 2-1) Start rolling : Carrier tape open space more than 20 Pieces.
 - 2-2) End of rolling : Carrier tape open space more than 20 Pieces, and 2 round of reel space at the cover tape only.
- 3) Taping quantity : 2,000 Pieces.
- 4) Seal off after putting each reels in a damp proof bag with silica gel.

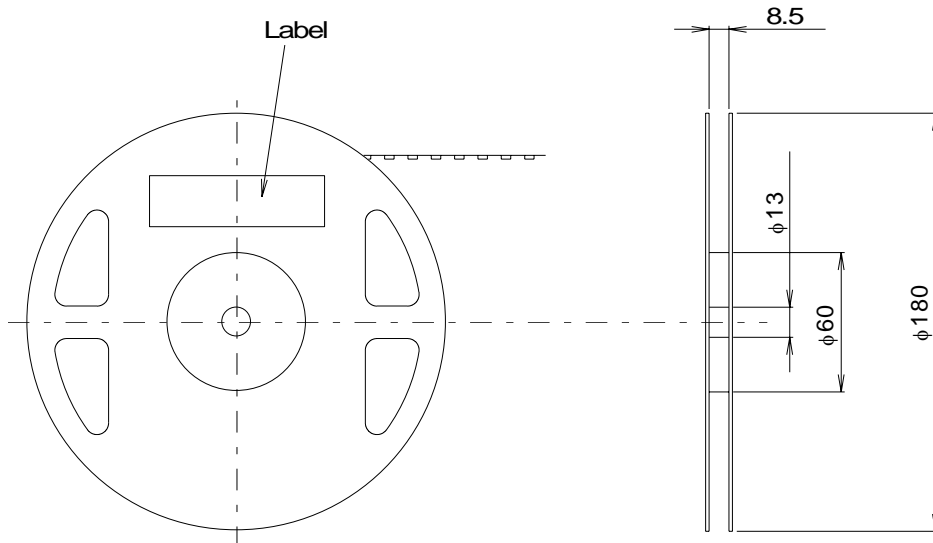

[CAUTION]
The specifications on this databook are only given for information, without any guarantee as regards either mistakes or omissions. The application circuits in this databook are described only to show representative usages of the product and not intended for the guarantee or permission of any right including the industrial rights.