

Features

- Peak pulse power: 600 W (10/1000 μ s)
- Stand off voltage range: from 5 V to 188 V
- Uni and bidirectional types
- Low clamping factor
- Fast response time
- JEDEC registered package outline

Description

The SMBJ series are TRANSIL™ diodes designed specifically for protecting sensitive equipment against transient overvoltages.

Transil diodes provide high overvoltage protection by clamping action. Their instantaneous response to transient overvoltages makes them particularly suited to protect voltage sensitive devices such as MOS Technology and low voltage supplied IC's.

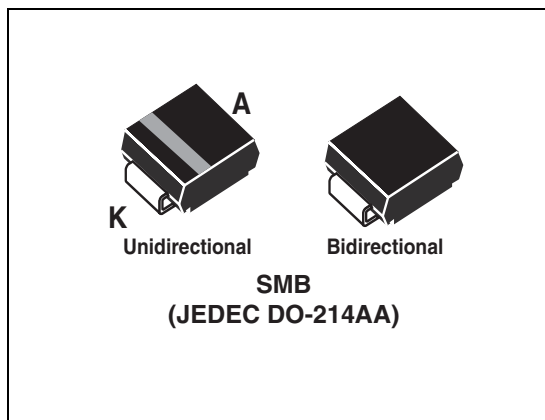

Order code

Part number	Marking
SMBJxxxA-TR	See pages 2 and 3
SMBJxxxCA-TR	See pages 2 and 3

Table 1. Absolute maximum ratings ($T_{amb} = 25^{\circ} C$)

Symbol	Parameter		Value	Unit
P_{PP}	Peak pulse power dissipation ⁽¹⁾	T_j initial = T_{amb}	600	W
P	Power dissipation on infinite heatsink	$T_{amb} = 50^{\circ} C$	5	W
I_{FSM}	Non repetitive surge peak forward current for unidirectional types	$t_p = 10$ ms T_j initial = T_{amb}	100	A
T_{stg}	Storage temperature range		-65 to +175	$^{\circ} C$
T_j	Maximum junction temperature		150	$^{\circ} C$
T_L	Maximum lead temperature for soldering during 10 s.		260	$^{\circ} C$

1. For a surge greater than the maximum values, the diode will fail in short-circuit.

Table 2. Thermal resistances

Symbol	Parameter	Value	Unit
$R_{th(j-l)}$	Junction to leads	20	$^{\circ} C/W$
$R_{th(j-a)}$	Junction to ambient on printed circuit on recommended pad layout	100	$^{\circ} C/W$

1 Electrical characteristics (Tamb = 25° C)

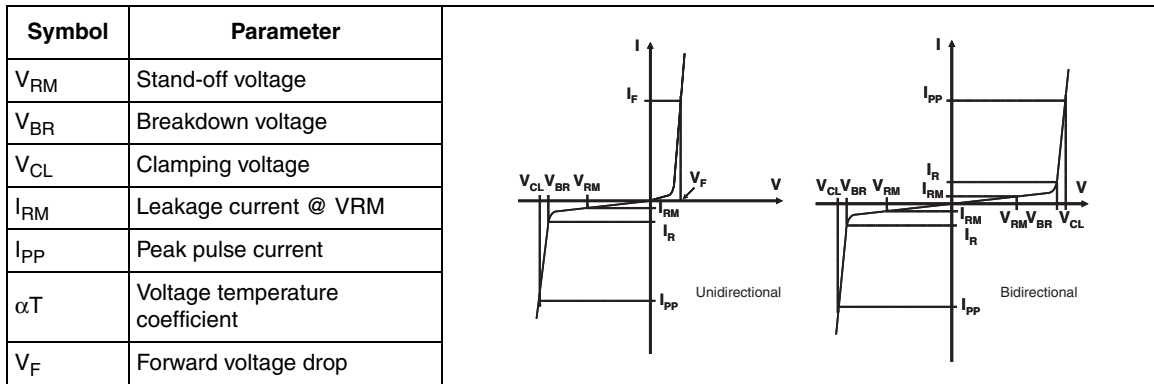

Types	Mark	Bidirectional	Mark	I_{RM} @ V_{RM} max.		V_{BR} @ I_R min. (1)		V_{CL} @ I_{PP} max. 10/1000 μ s		V_{CL} @ I_{PP} max. 8/20 μ s		αT max. (2)	C typ. (3)
				μ A	V	V	mA	V	A	V	A		
Unidirectional	Mark	Bidirectional	Mark	μ A	V	V	mA	V	A	V	A	10-4/°C	pF
SMBJ5.0A-TR	BUZ	SMBJ5.0CA-TR	BBZ	800	5.0	6.4	10	9.2	68	13.4	298	5.7	4000
SMBJ6.0A-TR	BUA	SMBJ6.0CA-TR	BBA	800	6.0	6.7	10	10.3	61	13.7	290	5.9	3850
SMBJ6.5A-TR	BUB	SMBJ6.5CA-TR	BBB	500	6.5	7.2	10	11.2	56	14.5	276	6.1	3700
SMBJ8.5A-TR	BUC	SMBJ8.5CA-TR	BBC	5	8.5	9.4	1	14.4	41.7	19.5	205	7.3	2800
SMBJ10A-TR	BUD	SMBJ10CA-TR	BBD	5	10	11.1	1	17	37	21.7	184	7.8	2300
SMBJ12A-TR	BUE	SMBJ12CA-TR	BBE	5	12	13.3	1	19.9	31	25.3	157	8.3	2025
SMBJ13A-TR	BUF	SMBJ13CA-TR	BBF	1	13	14.4	1	21.5	29	27.2	147	8.4	1900
SMBJ15A-TR	BUG	SMBJ15CA-TR	BBG	1	15	16.7	1	24.4	25.1	32.5	123	8.8	1600
SMBJ16A-TR	CUG	SMBJ16CA-TR	CBG	1	16	17.8	1	26	23.1	32.5	123	8.8	1600
SMBJ18A-TR	BUH	SMBJ18CA-TR	BBH	1	18	20	1	29.2	21.5	39.3	102	9.2	1350
SMBJ20A-TR	BUI	SMBJ20CA-TR	BBI	1	20	22.2	1	32.4	19.4	42.8	93	9.4	1250
SMBJ22A-TR	BVA	SMBJ22CA-TR	CBH	1	22	24.4	1	35.5	17.7	48.3	83	9.6	1150
SMBJ24A-TR	BUJ	SMBJ24CA-TR	BBJ	1	24	26.7	1	38.9	16	50	80	9.6	1112
SMBJ26A-TR	BUK	SMBJ26CA-TR	BBK	1	26	28.9	1	42.1	14.9	53.5	75	9.7	1075
SMBJ28A-TR	BUL	SMBJ28CA-TR	BBL	1	28	31.1	1	45.4	13.8	59	68	9.8	1000
SMBJ30A-TR	BUM	SMBJ30CA-TR	BBM	1	30	33.3	1	48.4	13	64.3	62	9.9	950
SMBJ33A-TR	BUN	SMBJ33CA-TR	BBN	1	33	36.7	1	53.3	11.8	69.7	57	10.0	900
SMBJ36A-TR	CUN	SMBJ36CA-TR	BBN	1	36	40.0	1	58.1	10.3	76	94	10.4	850
SMBJ40A-TR	CUJ	SMBJ40CA-TR	CBJ	1	40	44.4	1	64.5	9.7	84	48	10.1	800
SMBJ48A-TR	BUW	SMBJ48CA-TR	BBW	1	48	53.3	1	77.4	8.1	100	40	10.3	700
SMBJ58A-TR	BUO	SMBJ58CA-TR	BBO	1	58	64.4	1	93.6	6.7	121	33	10.4	625

Types				I _{RM} @ V _{RM} max.		V _{BR} @ I _R min. ⁽¹⁾		V _{CL} @ I _{PP} max. 10/1000 μs		V _{CL} @ I _{PP} max. 8/20 μs		αT max. ⁽²⁾	C typ. ⁽³⁾
				1	70	77.8	1	113	5.5	146	27		
SMBJ70A-TR	CUM	SMBJ70CA-TR	CBM	1	70	77.8	1	113	5.5	146	27	10.5	550
SMBJ85A-TR	BUQ	SMBJ85CA-TR	BBQ	1	85	94.4	1	137	4.6	178	22.5	10.6	500
SMBJ100A-TR	CUQ	SMBJ100CA-TR	CBQ	1	100	111	1	162	3.8	212	19	10.7	450
SMBJ130A-TR	BUS	SMBJ130CA-TR	BBS	1	130	144	1	209	3	265	15	10.8	400
SMBJ154A-TR	BUT	SMBJ154CA-TR	BBT	1	154	171	1	246	2.4	317	12.6	10.8	360
SMBJ170A-TR	BUU	SMBJ170CA-TR	BBU	1	170	189	1	275	2.2	353	11.3	10.8	350
SMBJ188A-TR	BUV	SMBJ188CA-TR	BBV	1	188	209	1	328	2	388	10.3	10.8	330

1. Pulse test : t_p < 50ms.
2. V_{BR} = αT * (T_{amb} - 25) * V_{BR}(25° C).
3. V_R = 0 V, F = 1 MHz. For bidirectional types, capacitance value is divided by 2.

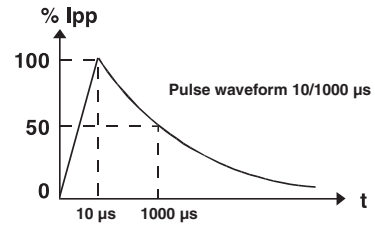

Figure 1. Peak pulse power dissipation versus initial junction temperature (printed circuit board).

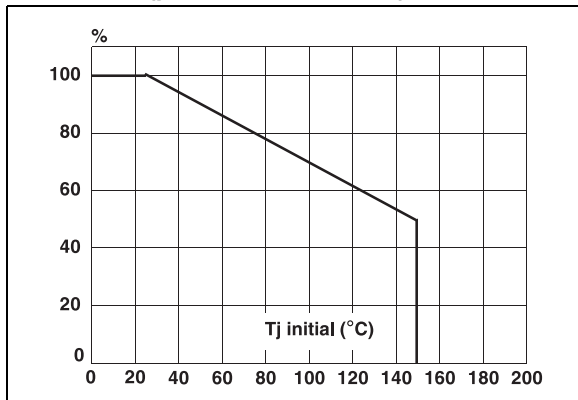

Figure 2. Peak pulse power versus exponential pulse duration.

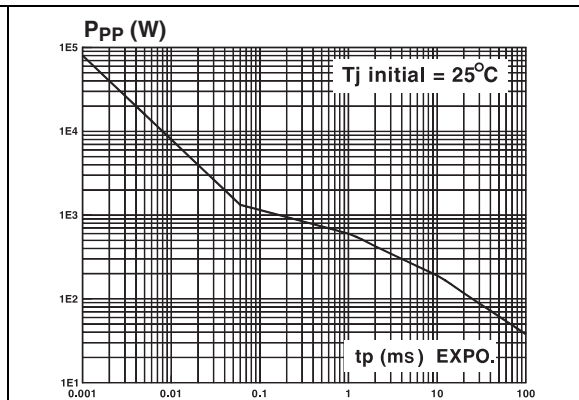
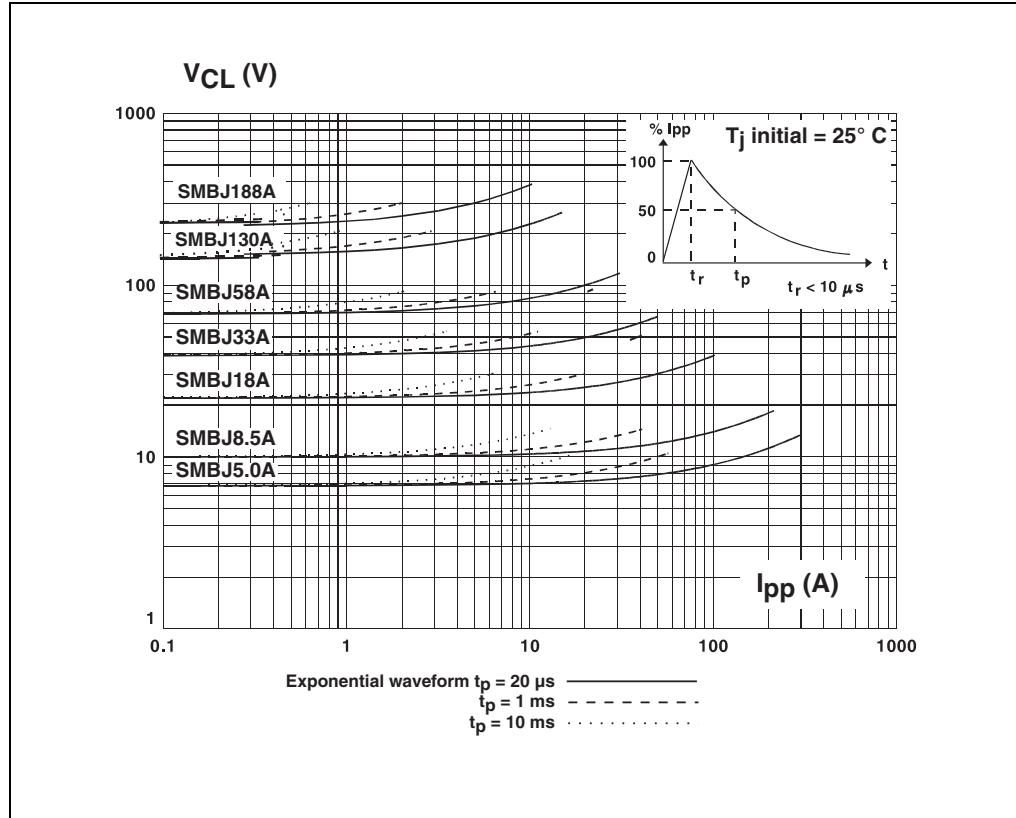

Figure 3. Clamping voltage versus peak pulse current.



Note: The curves of figure 3 are specified for a junction temperature of 25° C before surge. The given results may be extrapolated for other junction temperatures by using the following formula :

$$\Delta VBR = \alpha T * [T_{amb} - 25] * V_{BR}(25^\circ C)$$

For intermediate voltages, extrapolate the given results.

Figure 4. Capacitance versus reverse applied voltage for unidirectional types (typical values)

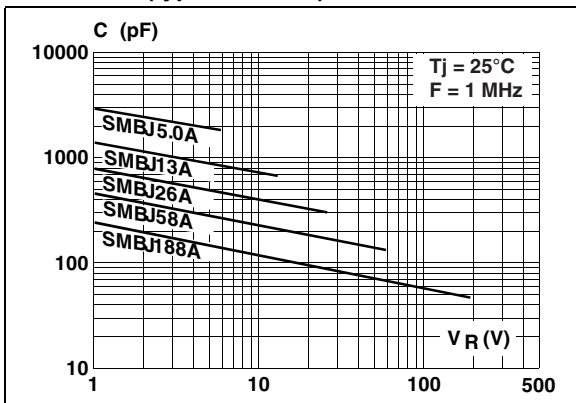

Figure 5. Capacitance versus reverse applied voltage for bidirectional types (typical values)

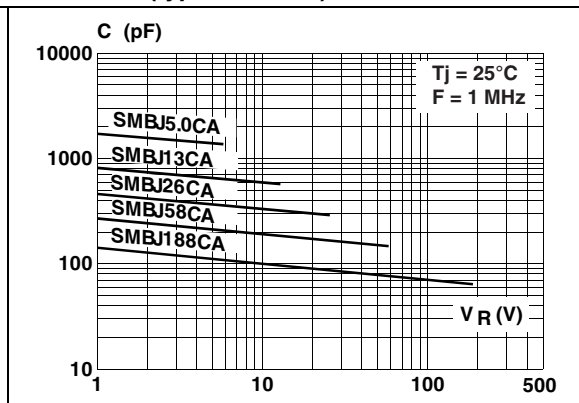

Figure 6. Peak forward voltage drop versus peak forward current (typical values for unidirectional types).

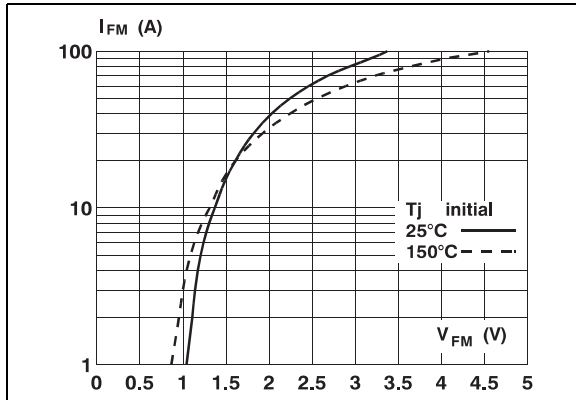

Figure 7. Transient thermal impedance junction-ambient versus pulse duration. Mounting on FR4 PC Board with Recommended pad layout.

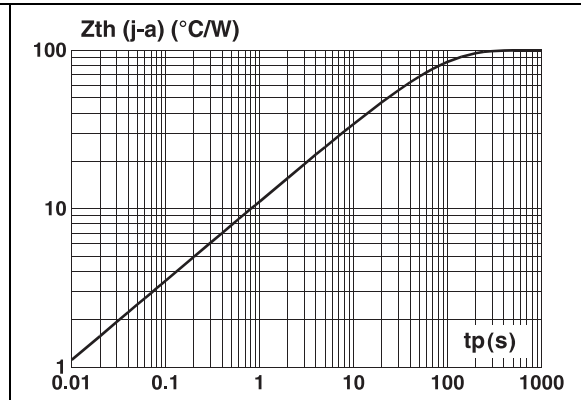
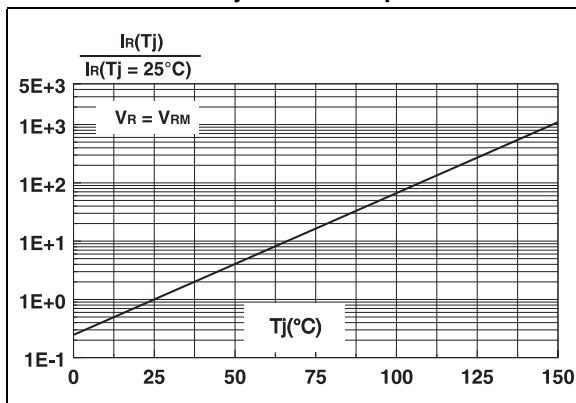
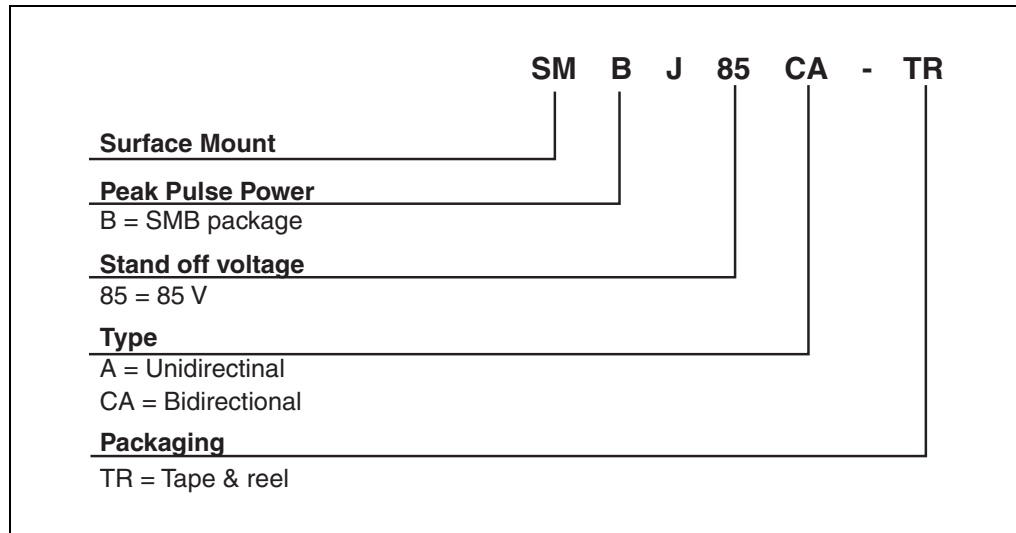

Figure 8. Relative variation of leakage current versus junction temperature.



2 Order code



3 Package mechanical data SMB (plastic)

Table 3. Dimensions

Ref.	Dimensions					
	Millimeters			Inches		
	Min.	Typ.	Max.	Min.	Typ.	Max.
A1	1.90	2.15	2.45	0.075	0.085	0.096
A2	0.05	0.15	0.20	0.002	0.006	0.008
b	1.95		2.20	0.077		0.087
c	0.15		0.41	0.006		0.016
E	5.10	5.40	5.60	0.201	0.213	0.220
E1	4.05	4.30	4.60	0.159	0.169	0.181
D	3.30	3.60	3.95	0.130	0.142	0.156
L	0.75	1.15	1.60	0.030	0.045	0.063

Figure 9. Footprint dimensions (millimeter)

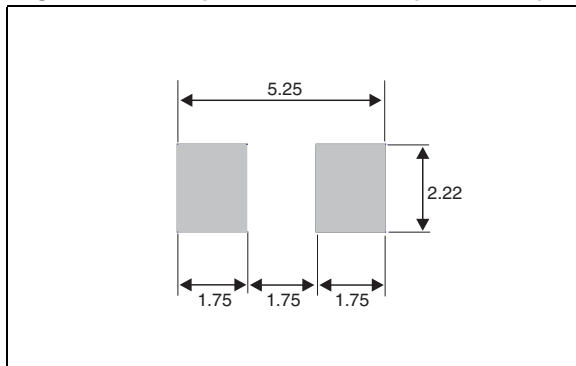
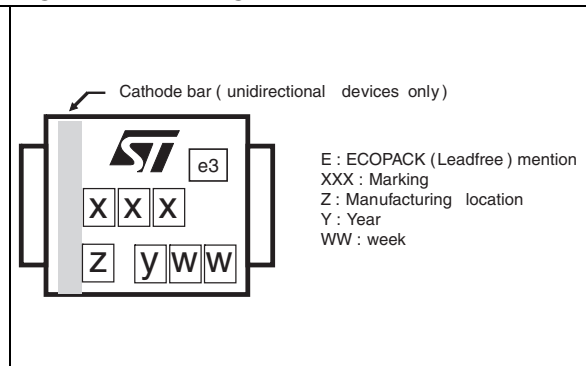

Figure 10. Marking



In order to meet environmental requirements, ST offers these devices in ECOPACK® packages. These packages have a Lead-free second level interconnect. The category of second level interconnect is marked on the package and on the inner box label, in compliance with JEDEC Standard JESD97. The maximum ratings related to soldering conditions are also marked on the inner box label. ECOPACK is an ST trademark. ECOPACK specifications are available at: www.st.com.

4 Ordering information

Part number	Marking	Package	Weight	Base qty	Delivery mode
SMBJxxxA-TR	See pages 2 and 3.	SMB	0.12 g	5000	Tape and reel
SMBJxxxCA-TR	See pages 2 and 3.	SMB	0.12 g	5000	Tape and reel

5 Revision history

Table 4. Document revision history

Date	Revision	Changes
Oct-2001	4	Previous issue
10-Feb-2005	5	Reformatted to current template. Added directional (uni and bi) indications to graphics. Added ECOPACK statement.
16-Nov-2006	6	Add part numbers SMBJ36A-TR and SMBJ36CA-TR on page 2.

Please Read Carefully:

Information in this document is provided solely in connection with ST products. STMicroelectronics NV and its subsidiaries ("ST") reserve the right to make changes, corrections, modifications or improvements, to this document, and the products and services described herein at any time, without notice.

All ST products are sold pursuant to ST's terms and conditions of sale.

Purchasers are solely responsible for the choice, selection and use of the ST products and services described herein, and ST assumes no liability whatsoever relating to the choice, selection or use of the ST products and services described herein.

No license, express or implied, by estoppel or otherwise, to any intellectual property rights is granted under this document. If any part of this document refers to any third party products or services it shall not be deemed a license grant by ST for the use of such third party products or services, or any intellectual property contained therein or considered as a warranty covering the use in any manner whatsoever of such third party products or services or any intellectual property contained therein.

UNLESS OTHERWISE SET FORTH IN ST'S TERMS AND CONDITIONS OF SALE ST DISCLAIMS ANY EXPRESS OR IMPLIED WARRANTY WITH RESPECT TO THE USE AND/OR SALE OF ST PRODUCTS INCLUDING WITHOUT LIMITATION IMPLIED WARRANTIES OF MERCHANTABILITY, FITNESS FOR A PARTICULAR PURPOSE (AND THEIR EQUIVALENTS UNDER THE LAWS OF ANY JURISDICTION), OR INFRINGEMENT OF ANY PATENT, COPYRIGHT OR OTHER INTELLECTUAL PROPERTY RIGHT.

UNLESS EXPRESSLY APPROVED IN WRITING BY AN AUTHORIZED ST REPRESENTATIVE, ST PRODUCTS ARE NOT RECOMMENDED, AUTHORIZED OR WARRANTED FOR USE IN MILITARY, AIR CRAFT, SPACE, LIFE SAVING, OR LIFE SUSTAINING APPLICATIONS, NOR IN PRODUCTS OR SYSTEMS WHERE FAILURE OR MALFUNCTION MAY RESULT IN PERSONAL INJURY, DEATH, OR SEVERE PROPERTY OR ENVIRONMENTAL DAMAGE. ST PRODUCTS WHICH ARE NOT SPECIFIED AS "AUTOMOTIVE GRADE" MAY ONLY BE USED IN AUTOMOTIVE APPLICATIONS AT USER'S OWN RISK.

Resale of ST products with provisions different from the statements and/or technical features set forth in this document shall immediately void any warranty granted by ST for the ST product or service described herein and shall not create or extend in any manner whatsoever, any liability of ST.

ST and the ST logo are trademarks or registered trademarks of ST in various countries.

Information in this document supersedes and replaces all information previously supplied.

The ST logo is a registered trademark of STMicroelectronics. All other names are the property of their respective owners.

© 2006 STMicroelectronics - All rights reserved

STMicroelectronics group of companies

Australia - Belgium - Brazil - Canada - China - Czech Republic - Finland - France - Germany - Hong Kong - India - Israel - Italy - Japan - Malaysia - Malta - Morocco - Singapore - Spain - Sweden - Switzerland - United Kingdom - United States of America

www.st.com