

# NUS2045MN, NUS3045MN

## Overvoltage Protection IC with Integrated MOSFET

These devices represent a new level of safety and integration by combining the NCP345 overvoltage protection circuit (OVP) with a 20 V P-channel power MOSFET (NUS2045MN) or with a 30 V P-channel power MOSFET (NUS3045MN). They are specifically designed to protect sensitive electronic circuitry from overvoltage transients and power supply faults. During such hazardous events, the IC quickly disconnects the input supply from the load, thus protecting the load before any damage can occur.

The OVP ICs are optimized for applications using an external AC-DC adapter or a car accessory charger to power a portable product or recharge its internal batteries. They have a nominal overvoltage threshold of 6.85 V which makes them ideal for single cell Li-Ion as well as 3/4 cell NiCD/NiMH applications.

### Features

- Overvoltage Turn-Off Time of Less Than 1.0  $\mu$ s
- Accurate Voltage Threshold of 6.85 V, Nominal
- Undervoltage Lockout Protection; 2.8 V, Nominal
- Control Input Compatible with 1.8 V Logic Levels
- -20 V or -30 V Integrated P-Channel Power MOSFET
- Low  $R_{DS(on)}$  = 71 m $\Omega$  @ -4.5 V for NUS2045MN  
Low  $R_{DS(on)}$  = 66 m $\Omega$  @ -4.5 V for NUS3045MN
- Low Profile 3.3 x 3.3 mm DFN Package Suitable for Portable Applications
- Maximum Solder Reflow temperature @ 235°C for MNT1 suffix and 260°C for MNT1G suffix
- Pb-Free Packages are Available

### Benefits

- Provide Battery Protection
- Integrated Solution Offers Cost and Space Savings
- Integrated Solution Improves System Reliability

### Applications

- Portable Computers and PDAs
- Cell Phones and Handheld Products
- Digital Cameras



ON Semiconductor®

<http://onsemi.com>

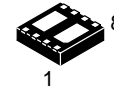

DFN8  
CASE 506AL

### MARKING DIAGRAM

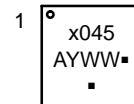

x045 = Device Code  
x = 2 or 3  
A = Assembly Location  
Y = Year  
WW = Work Week  
▪ = Pb-Free Package  
(Note: Microdot may be in either location)

### PIN ASSIGNMENT

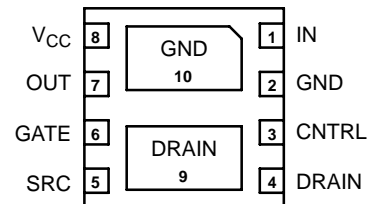

(Bottom View)

### ORDERING INFORMATION

Device	Package	Shipping†
NUS2045MNT1	DFN8	3000 Tape & Reel
NUS2045MNT1G	DFN8 (Pb-Free)	3000 Tape & Reel
NUS3045MNT1	DFN8	3000 Tape & Reel
NUS3045MNT1G	DFN8 (Pb-Free)	3000 Tape & Reel

†For information on tape and reel specifications, including part orientation and tape sizes, please refer to our Tape and Reel Packaging Specification Brochure, BRD8011/D.

# NUS2045MN, NUS3045MN

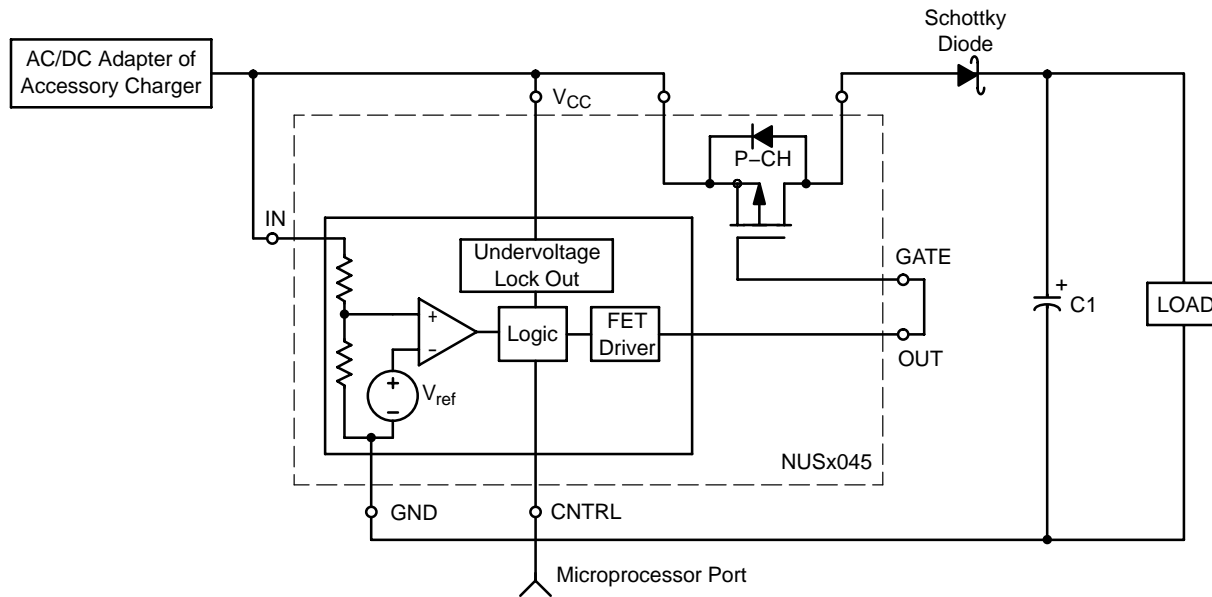

**Figure 1. Simplified Schematic**

## PIN FUNCTION DESCRIPTIONS

Pin #	Symbol	Pin Description
1	IN	This pin senses an external voltage point. If the voltage on this input rises above the overvoltage threshold ( $V_{TH}$ ), the OUT pin will be driven to within 1.0 V of $V_{CC}$ , thus disconnecting the FET. The nominal threshold level is 6.85 V and this threshold level can be increased with the addition of an external resistor between IN and $V_{CC}$ .
2, 10	GND	Circuit Ground
3	CNTRL	This logic signal is used to control the state of OUT and turn-on/off the P-channel MOSFET. A logic High results in the OUT signal being driven to within 1.0 V of $V_{CC}$ which disconnects the FET. If this pin is not used, the input should be connected to ground.
4, 9	DRAIN	Drain pin of the power MOSFET
5	SRC	Source pin of the power MOSFET
6	GATE	Gate pin of the power MOSFET
7	OUT	This signal drives the gate of a P-channel MOSFET. It is controlled by the voltage level on IN or the logic state of the CNTRL input. When an overvoltage event is detected, the OUT pin is driven to within 1.0 V of $V_{CC}$ in less than 1.0 $\mu$ sec provided that gate and stray capacitance is less than 12 nF.
8	$V_{CC}$	Positive Voltage supply. If $V_{CC}$ falls below 2.8 V (nom), the OUT pin will be driven to within 1.0 V of $V_{CC}$ , thus disconnecting the P-channel FET.

## OVERVOLTAGE PROTECTION CIRCUIT TRUTH TABLE

IN	CNTRL	OUT
$<V_{th}$	L	GND
$<V_{th}$	H	$V_{CC}$
$>V_{th}$	L	$V_{CC}$
$>V_{th}$	H	$V_{CC}$

# NUS2045MN, NUS3045MN

## MAXIMUM RATINGS (T<sub>A</sub> = 25°C unless otherwise stated)

Rating	Pin	Symbol	Min	Max	Unit
OUT Voltage to GND	7	V <sub>O</sub>	-0.3	30	V
Input and CNTRL Pin Voltage to GND	1 3	V <sub>input</sub> V <sub>CNTRL</sub>	-0.3 -0.3	30 13	V
VCC Maximum Range	8	V <sub>CC(max)</sub>	-0.3	30	V
Maximum Power Dissipation (Note 1)	-	P <sub>D</sub>	-	1.0	W
Thermal Resistance Junction-to-Air (Note 1)					
		OVP IC		108.6	°C/W
		P-Channel FET		104.3	
Junction Temperature	-	T <sub>J</sub>	-	150	°C
Operating Ambient Temperature	-	T <sub>A</sub>	-40	85	°C
V <sub>CNTRL</sub> Operating Voltage	3	-	0	5.0	V
Storage Temperature Range	-	T <sub>stg</sub>	-65	150	°C
ESD Performance (HBM) (Note 2)	1,2,3,7,8,10	-	2.5	-	kV
Drain-to-Source Voltage		V <sub>DSS</sub>			V
	NUS2045MN			-20	
	NUS3045MN			-30	
Gate-to-Source Voltage		V <sub>GS</sub>			V
	NUS2045MN		-8	8	
	NUS3045MN		-20	20	
Continuous Drain Current, Steady State, T <sub>A</sub> = 25°C (Note 1)		I <sub>D</sub>			A
	NUS2045MN			-1.0	
	NUS3045MN			-1.0	

Stresses exceeding Maximum Ratings may damage the device. Maximum Ratings are stress ratings only. Functional operation above the Recommended Operating Conditions is not implied. Extended exposure to stresses above the Recommended Operating Conditions may affect device reliability.

1. Surface-mounted on FR4 board using 1 inch sq pad size (Cu area = 1.127 in sq [1 oz] including traces).
2. Human body model (HBM): MIL STD 883C Method 3015-7, (R = 1500 Ω, C = 100 pF, F = 3 pulses delay 1 s).

# NUS2045MN, NUS3045MN

## ELECTRICAL CHARACTERISTICS (T<sub>A</sub> = 25°C, V<sub>CC</sub> = 6.0 V, unless otherwise specified)

Characteristic	Symbol	Pin	Min	Typ	Max	Unit
V <sub>CC</sub> Operating Voltage Range	V <sub>CC(opt)</sub>	8	3.0	4.8	25	V
Supply Current (I <sub>CC</sub> + I <sub>Input</sub> ; V <sub>CC</sub> = 6.0 V Steady State)	–	1, 8	–	0.75	1.0	mA
Input Threshold (V <sub>Input</sub> connected to V <sub>CC</sub> ; V <sub>Input</sub> increasing)	V <sub>Th</sub>	1	6.65	6.85	7.08	V
Input Hysteresis (V <sub>Input</sub> connected to V <sub>CC</sub> ; V <sub>Input</sub> decreasing)	V <sub>Hyst</sub>	1	50	100	200	mV
Input Impedance (Input = V <sub>Th</sub> )	R <sub>in</sub>	1	70	150	–	kΩ
CNTRL Voltage High	V <sub>ih</sub>	3	1.5	–	–	V
CNTRL Voltage Low	V <sub>il</sub>	3	–	–	0.5	V
CNTRL Current High (V <sub>ih</sub> = 5.0 V)	I <sub>ih</sub>	3	–	95	200	μA
CNTRL Current Low (V <sub>il</sub> = 0.5 V)	I <sub>il</sub>	3	–	10	20	μA
Undervoltage Lockout (V <sub>CC</sub> decreasing)	V <sub>Lock</sub>	3	2.5	2.8	3.0	V
Output Sink Current (V <sub>CC</sub> < V <sub>Th</sub> , V <sub>OUT</sub> = 1.0 V)	I <sub>Sink</sub>	7	10	33	50	μA
Output Voltage High (V <sub>CC</sub> = V <sub>in</sub> = 8.0 V; I <sub>Source</sub> = 10 mA) Output Voltage High (V <sub>CC</sub> = V <sub>in</sub> = 8.0 V; I <sub>Source</sub> = 0.25 mA) Output Voltage High (V <sub>CC</sub> = V <sub>in</sub> = 8.0 V; I <sub>Source</sub> = 0 mA)	V <sub>oh</sub>	7	V <sub>CC</sub> -1.0 V <sub>CC</sub> -0.25 V <sub>CC</sub> -0.1	–	–	V
Output Voltage Low (Input < 6.5 V; I <sub>Sink</sub> = 0 mA; V <sub>CC</sub> = 6.0 V, CNTRL = 0 V)	V <sub>ol</sub>	7	–	–	0.1	V
Turn ON Delay – Input (Note 3) (V <sub>Input</sub> connected to V <sub>CC</sub> ; V <sub>Input</sub> step down signal from 8.0 to 6.0 V; measured to 50% point of OUT)*	T <sub>ON IN</sub>	7	–	–	10	μs
Turn OFF Delay – Input (V <sub>Input</sub> connected to V <sub>CC</sub> ; V <sub>Input</sub> step up signal from 6.0 to 8.0 V; C <sub>L</sub> = 12 nF Output > V <sub>CC</sub> – 1.0 V)	T <sub>OFF IN</sub>	7	–	0.5	1.0	μs
Turn ON Delay – CNTRL (CNTRL step down signal from 2.0 to 0.5 V; measured to 50% point of OUT) (Note 3)	T <sub>ON CT</sub>	7	–	–	10	μs
Turn OFF Delay – CNTRL (CNTRL step up signal from 0.5 to 2.0 V; C <sub>L</sub> = 12 nF Output > V <sub>CC</sub> – 1.0 V)	T <sub>OFF CT</sub>	7	–	1.0	2.0	μs

3. Guaranteed by design.

# NUS2045MN, NUS3045MN

## P-CHANNEL MOSFET

Parameter	Symbol	Min	Typ	Max	Units
Drain to Source On Resistance $V_{GS} = -4.5\text{ V}, I_D = 600\text{ mA}$ $V_{GS} = -4.5\text{ V}, I_D = 1.0\text{ A}$ $V_{GS} = -4.5\text{ V}, I_D = 600\text{ mA}$ $V_{GS} = -4.5\text{ V}, I_D = 1.0\text{ A}$	$R_{DS(on)}$		71 71 66 66	95 95 110 110	$m\Omega$
Zero Gate Voltage Drain Current $V_{GS} = 0\text{ V}, V_{DS} = -16\text{ V}$ $V_{GS} = 0\text{ V}, V_{DS} = -24\text{ V}$	$I_{DSS}$			-1.0 -1.0	$\mu\text{A}$
Turn On Delay (Note 4) $V_{GS} = -4.5\text{ V}$ $V_{GS} = -4.5\text{ V}$	$t_{on}$		7.5 11		ns
Turn Off Delay (Note 4) $V_{GS} = -4.5\text{ V}$ $V_{GS} = -4.5\text{ V}$	$t_{off}$		30.2 28		ns
Input Capacitance (Note 3) $V_{GS} = 0\text{ V}, f = 1.0\text{ MHz}, V_{DS} = -10\text{ V}$ $V_{GS} = 0\text{ V}, f = 1.0\text{ MHz}, V_{DS} = -15\text{ V}$	$C_{in}$		675 750		$\mu\text{F}$
Gate to Source Leakage Current $V_{GS} = \pm 8.0\text{ V}, V_{DS} = 0\text{ V}$ $V_{GS} = \pm 20\text{ V}, V_{DS} = 0\text{ V}$	$I_{GSS}$		$\pm 10$ $\pm 10$		nA
Drain to Source Breakdown Voltage $V_{GS} = 0\text{ V}, I_D = -250\text{ }\mu\text{A}$	$V_{(BR)DSS}$	20 30			V
Gate Threshold Voltage $V_{GS} = V_{DS}, I_D = -250\text{ }\mu\text{A}$	$V_{(GS)th}$	-1.2 -3.0		-0.4 -1.0	V

4. Switching characteristics are independent of operating junction temperature.

# NUS2045MN, NUS3045MN

## TYPICAL PERFORMANCE CURVES

( $T_A = 25^\circ\text{C}$ , unless otherwise specified)

### OVERVOLTAGE PROTECTION IC

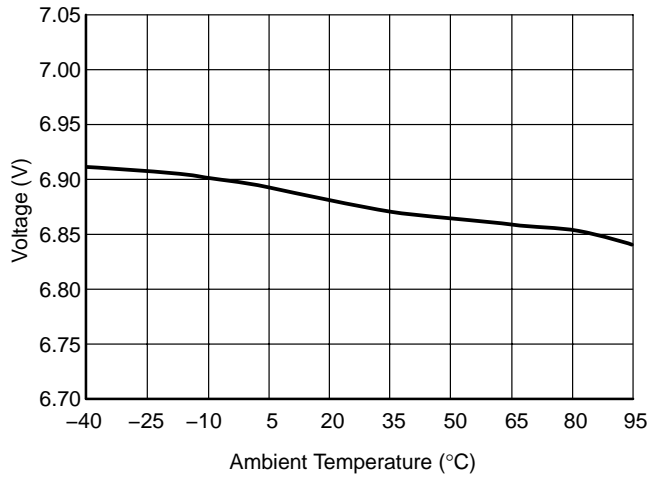

Figure 2. Typical  $V_{th}$  Threshold Variation vs. Temperature

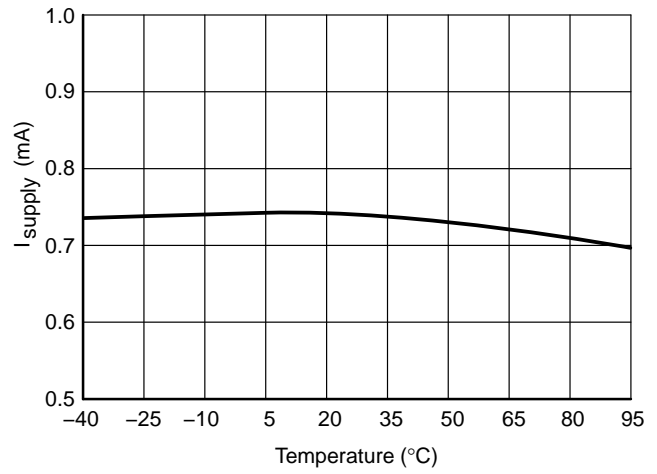

Figure 3. Typical Supply Current vs. Temperature  
 $I_{CC} + I_{in}$ ,  $V_{CC} = 6\text{ V}$

# NUS2045MN, NUS3045MN

## TYPICAL PERFORMANCE CURVES

( $T_A = 25^\circ\text{C}$ , unless otherwise specified)

### 30 V, P-CHANNEL MOSFET

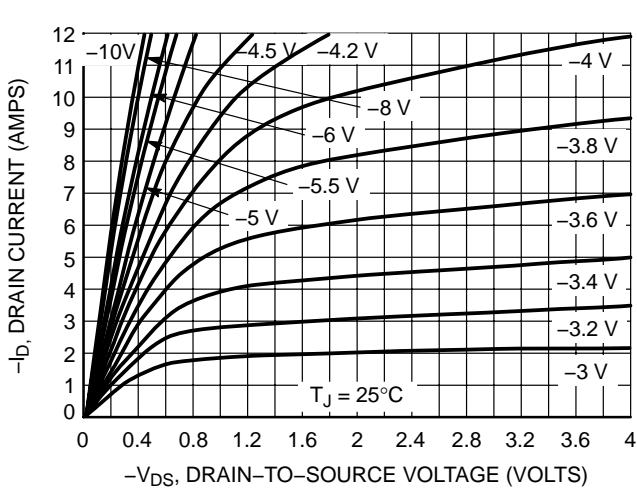

Figure 4. On-Region Characteristics

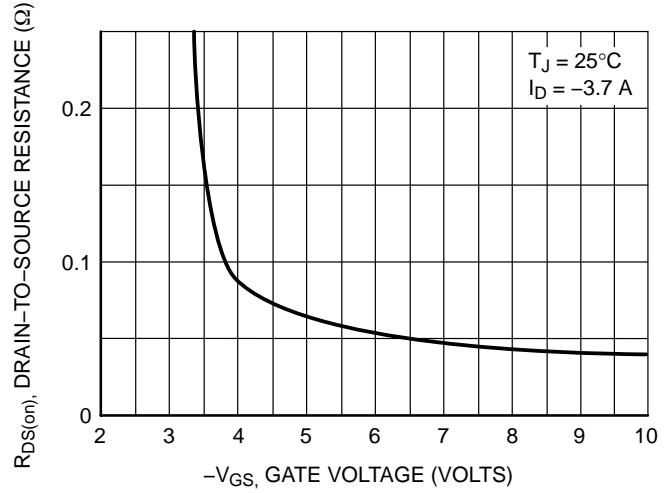

Figure 5. On-Resistance vs. Gate-to-Source Voltage

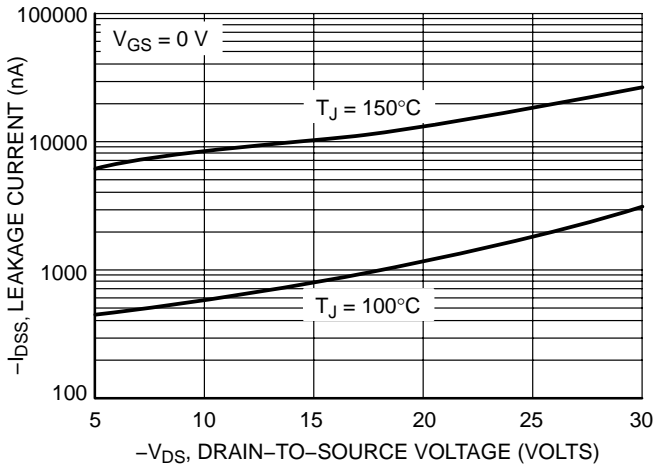

Figure 6. Drain-to-Source Leakage Current vs. Voltage

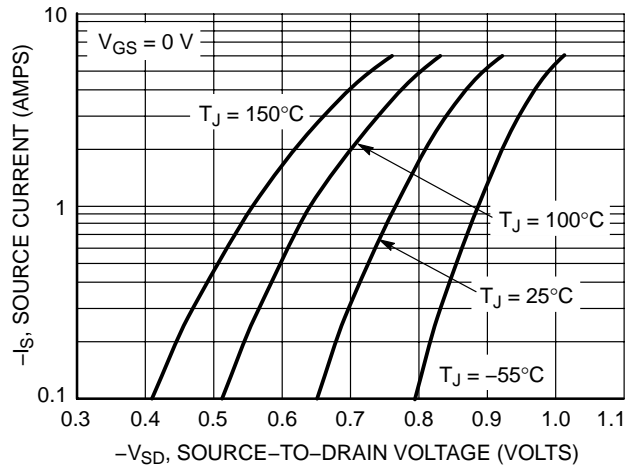

Figure 7. Diode Forward Voltage vs. Current

# NUS2045MN, NUS3045MN

## TYPICAL PERFORMANCE CURVES

( $T_A = 25^\circ\text{C}$ , unless otherwise specified)

### 20 V, P-CHANNEL MOSFET

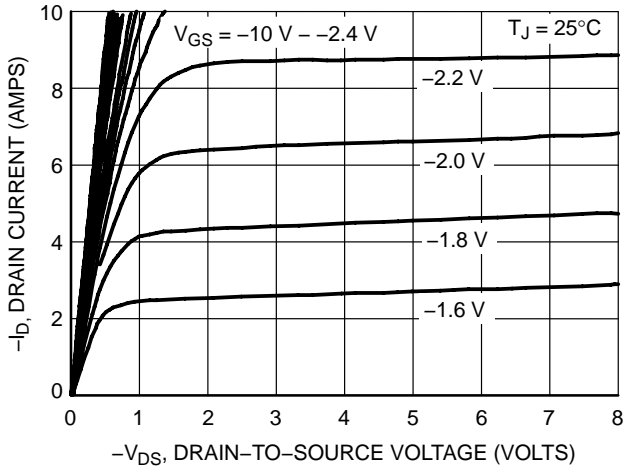

Figure 8. On-Region Characteristics

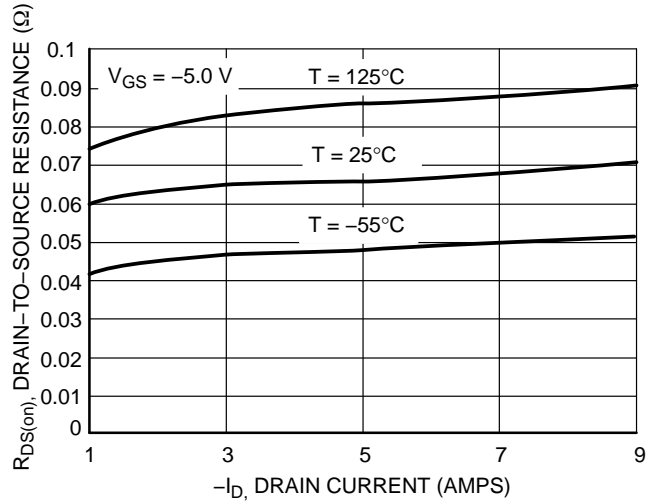

Figure 9. On-Resistance vs. Drain Current and Temperature

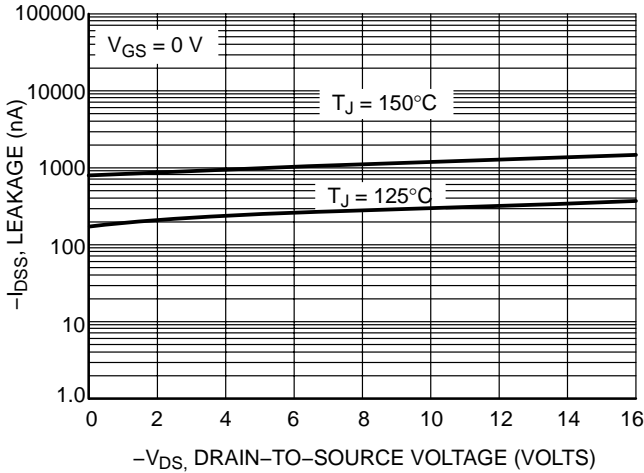

Figure 10. Drain-to-Source Leakage Current vs. Voltage

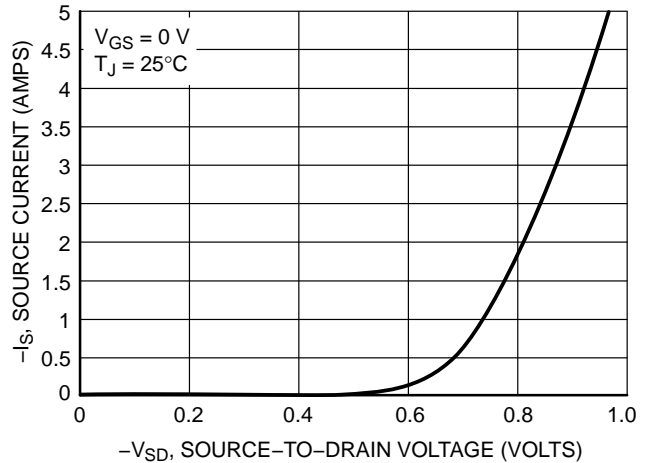

Figure 11. Diode Forward Voltage vs. Current



# NUS2045MN, NUS3045MN

## TYPICAL APPLICATION CIRCUITS & OPERATION WAVEFORMS

( $T_A = 25^\circ\text{C}$ , unless otherwise specified)

### 20 V, P-CHANNEL MOSFET

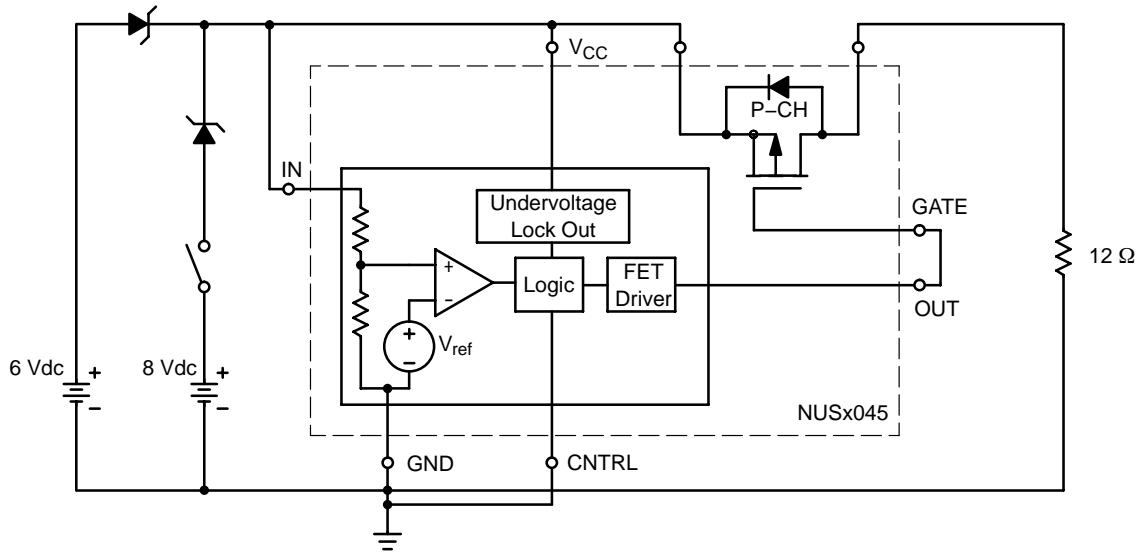

Figure 12. Test Circuit for  $T_{ON IN}$  and  $T_{OFF IN}$

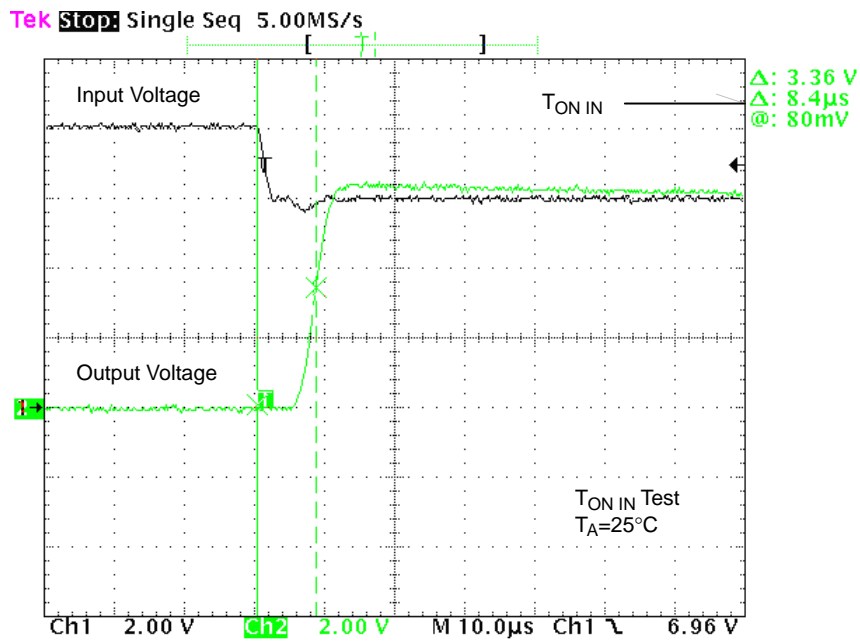

Figure 13.  $T_{ON IN}$  Waveforms

# NUS2045MN, NUS3045MN

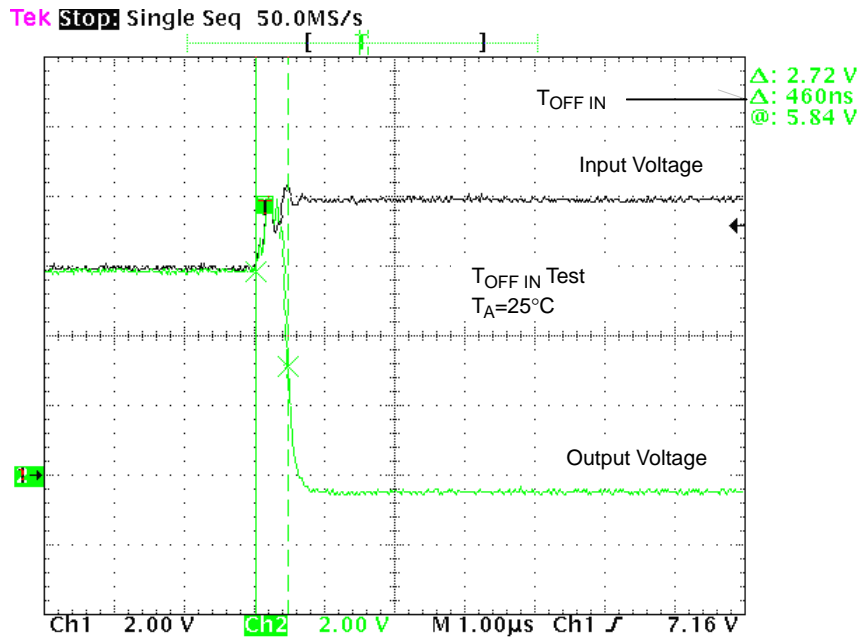

Figure 14.  $T_{OFF IN}$  Waveforms

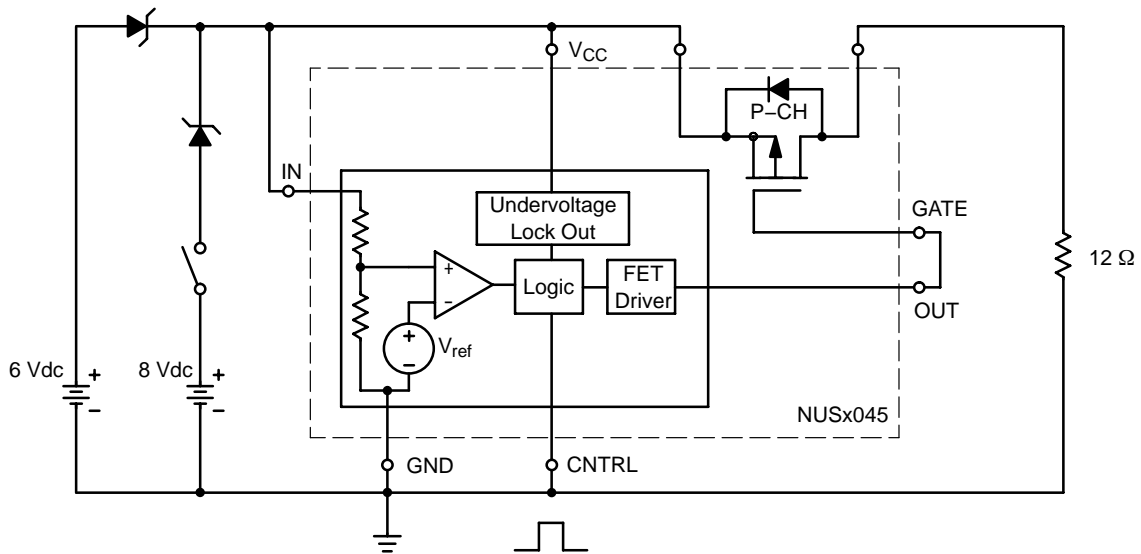

Figure 15. Test Circuit for  $T_{ON CT}$  and  $T_{OFF CT}$

# NUS2045MN, NUS3045MN

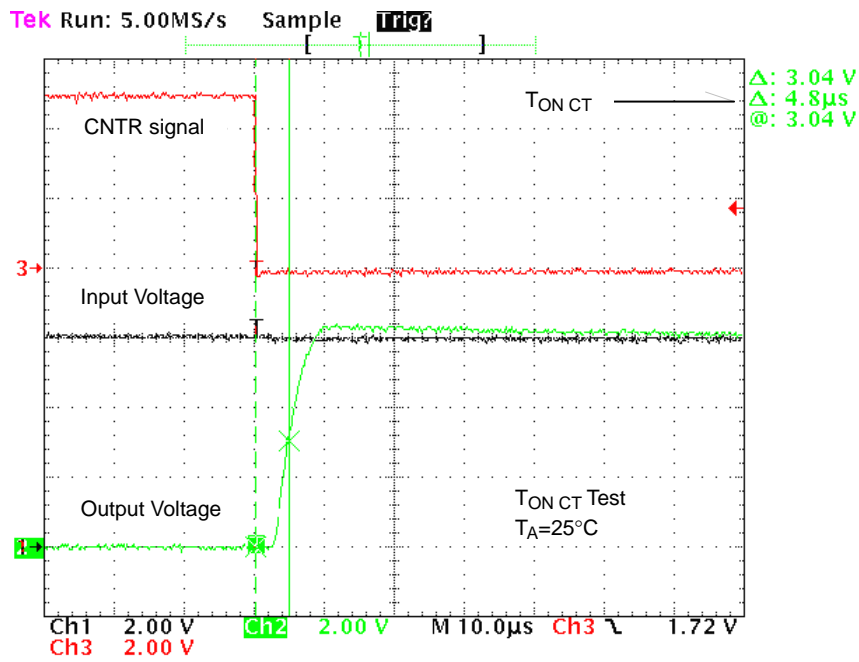

Figure 16. TON CT Waveforms

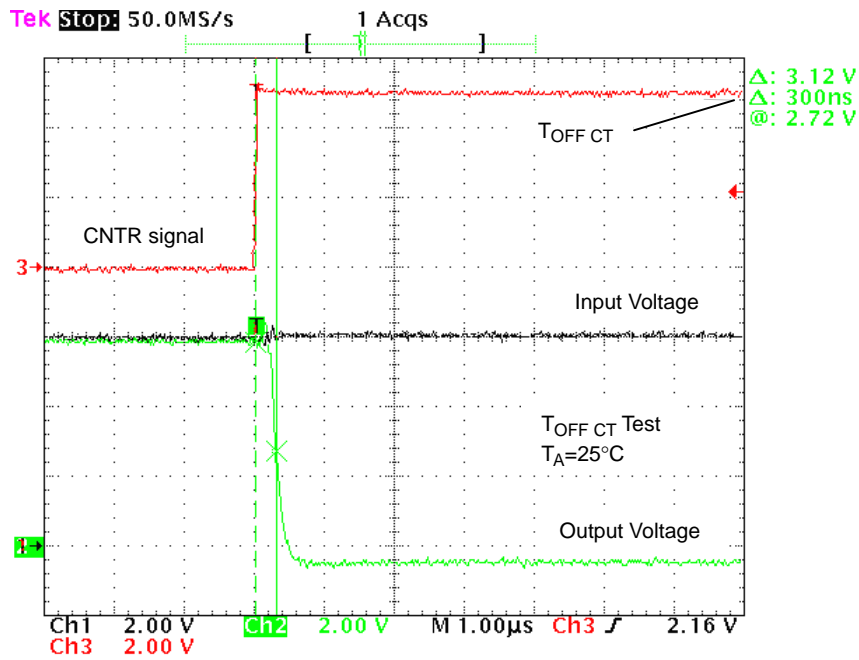
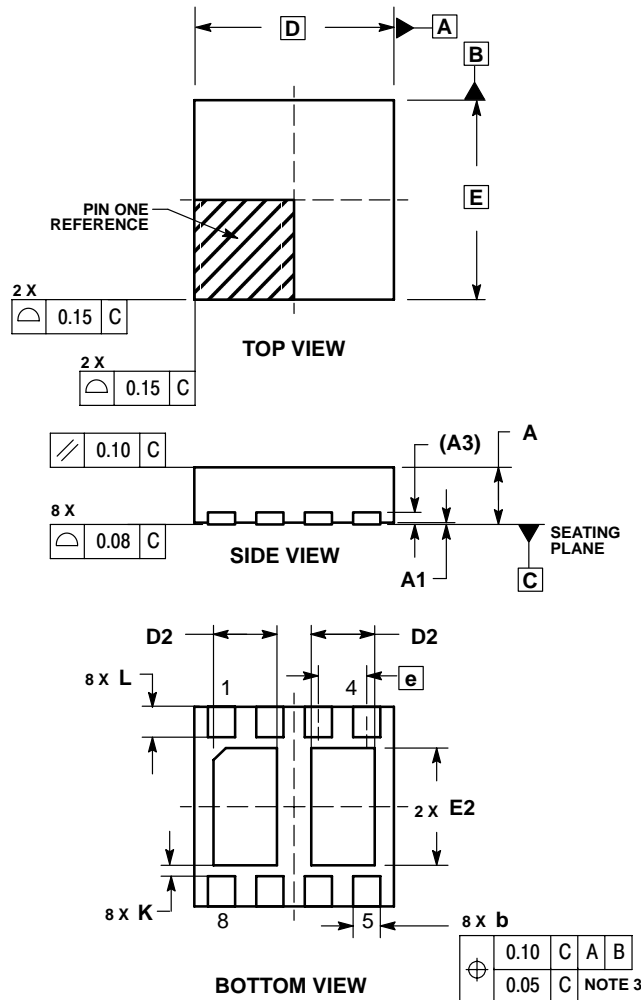

Figure 17. TOFF CT Waveforms

# NUS2045MN, NUS3045MN

## PACKAGE DIMENSIONS

DFN8  
CASE 506AL-01  
ISSUE A



NOTES:

1. DIMENSIONING AND TOLERANCING PER ASME Y14.5M, 1994.
2. CONTROLLING DIMENSION: MILLIMETERS.
3. DIMENSION b APPLIES TO PLATED TERMINAL AND IS MEASURED BETWEEN 0.25 AND 0.30mm.
4. COPLANARITY APPLIES TO THE EXPOSED PAD AS WELL AS THE TERMINALS.

DIM	MILLIMETERS		
	MIN	NOM	MAX
A	0.80	0.90	1.00
A1	0.00	0.03	0.05
A3	0.20 REF		
b	0.35	0.40	0.45
D	3.30 BSC		
D2	0.95	1.05	1.15
E	3.30 BSC		
E2	1.80	1.90	2.00
e	0.80 BSC		
K	0.21	---	---
L	0.30	0.40	0.50

### SOLDERING FOOTPRINT\*

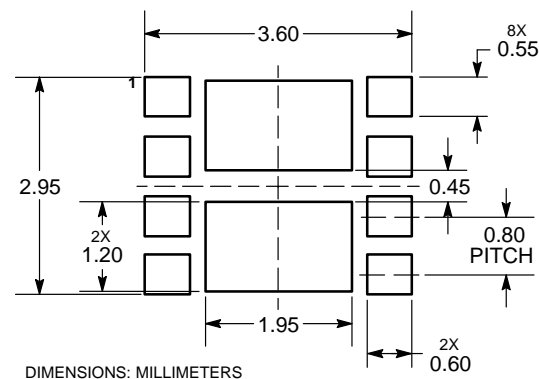

\*For additional information on our Pb-Free strategy and soldering details, please download the ON Semiconductor Soldering and Mounting Techniques Reference Manual, SOLDERRM/D.

ON Semiconductor and are registered trademarks of Semiconductor Components Industries, LLC (SCILLC). SCILLC reserves the right to make changes without further notice to any products herein. SCILLC makes no warranty, representation or guarantee regarding the suitability of its products for any particular purpose, nor does SCILLC assume any liability arising out of the application or use of any product or circuit, and specifically disclaims any and all liability, including without limitation special, consequential or incidental damages. "Typical" parameters which may be provided in SCILLC data sheets and/or specifications can and do vary in different applications and actual performance may vary over time. All operating parameters, including "Typicals" must be validated for each customer application by customer's technical experts. SCILLC does not convey any license under its patent rights nor the rights of others. SCILLC products are not designed, intended, or authorized for use as components in systems intended for surgical implant into the body, or other applications intended to support or sustain life, or for any other application in which the failure of the SCILLC product could create a situation where personal injury or death may occur. Should Buyer purchase or use SCILLC products for any such unintended or unauthorized application, Buyer shall indemnify and hold SCILLC and its officers, employees, subsidiaries, affiliates, and distributors harmless against all claims, costs, damages, and expenses, and reasonable attorney fees arising out of, directly or indirectly, any claim of personal injury or death associated with such unintended or unauthorized use, even if such claim alleges that SCILLC was negligent regarding the design or manufacture of the part. SCILLC is an Equal Opportunity/Affirmative Action Employer. This literature is subject to all applicable copyright laws and is not for resale in any manner.

### PUBLICATION ORDERING INFORMATION

**LITERATURE FULFILLMENT:**  
Literature Distribution Center for ON Semiconductor  
P.O. Box 5163, Denver, Colorado 80217 USA  
Phone: 303-675-2175 or 800-344-3860 Toll Free USA/Canada  
Fax: 303-675-2176 or 800-344-3867 Toll Free USA/Canada  
Email: orderlit@onsemi.com

**N. American Technical Support:** 800-282-9855 Toll Free  
USA/Canada  
**Europe, Middle East and Africa Technical Support:**  
Phone: 421 33 790 2910  
**Japan Customer Focus Center**  
Phone: 81-3-5773-3850

**ON Semiconductor Website:** [www.onsemi.com](http://www.onsemi.com)  
**Order Literature:** <http://www.onsemi.com/orderlit>  
For additional information, please contact your local Sales Representative

NUS2045MN/D