

M A T183T

This item can replace **BFR183T**

Approved by:
Checked by:
Issued by:

SPECIFICATION

PRODUCT: NPN 8GHz wideband transistor

MODEL: M A T183T SOT523

HOPE MICROELECTRONICS CO.,LIMITED

Tel:+86-755-82973806 Fax:+86-755-82973550 E-mail: sales@hoperf.com <http://www.hoperf.com>

Page 1 of 7

M A T183T

This item can replace **BFR183T**

NPN RF Transistor

Preliminary data

- For low-noise, high-gain broadband amplifiers at collector currents from 2 mA to 30 mA
- $f_T = 8$ GHz
 $F = 1.2$ dB at 900 MHz

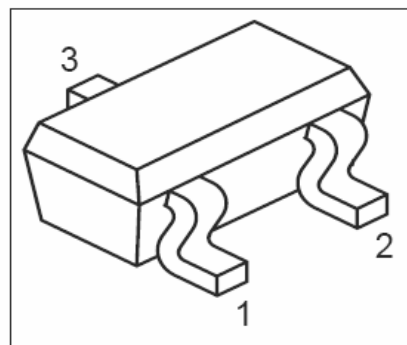

ESD: Electrostatic discharge sensitive device, observe handling precaution!

Type	Marking	Pin Configuration			Package
MAS183T	RHs	1 = B	2 = E	3 = C	SC75

Maximum Ratings

Parameter	Symbol	Value	Unit
Collector-emitter voltage	V_{CEO}	12	V
Collector-emitter voltage	V_{CES}	20	
Collector-base voltage	V_{CBO}	20	
Emitter-base voltage	V_{EBO}	2	
Collector current	I_C	65	mA
Base current	I_B	5	
Total power dissipation $T_S \leq 83^\circ\text{C}^{1)}$	P_{tot}	250	mW
Junction temperature	T_j	150	$^\circ\text{C}$
Ambient temperature	T_A	-65 ... 150	
Storage temperature	T_{stg}	-65 ... 150	

Thermal Resistance

Junction - soldering point ²⁾	R_{thJS}	≤ 270	K/W
--	------------	------------	-----

¹⁾ T_S is measured on the collector lead at the soldering point to the pcb

²⁾ For calculation of R_{thJA} please refer to Application Note Thermal Resistance

M A T183T

This item can replace **BFR183T**

Electrical Characteristics at $T_A = 25^\circ\text{C}$, unless otherwise specified.

Parameter	Symbol	Values			Unit
		min.	typ.	max.	
DC characteristics					
Collector-emitter breakdown voltage $I_C = 1 \text{ mA}, I_B = 0$	$V_{(BR)CEO}$	12	-	-	V
Collector-emitter cutoff current $V_{CE} = 20 \text{ V}, V_{BE} = 0$	I_{CES}	-	-	100	μA
Collector-base cutoff current $V_{CB} = 10 \text{ V}, I_E = 0$	I_{CBO}	-	-	100	nA
Emitter-base cutoff current $V_{EB} = 1 \text{ V}, I_C = 0$	I_{EBO}	-	-	1	μA
DC current gain $I_C = 15 \text{ mA}, V_{CE} = 8 \text{ V}$	h_{FE}	50	100	200	-

M A T183T

This item can replace **BFR183T**

Electrical Characteristics at $T_A = 25^\circ\text{C}$, unless otherwise specified.

Parameter	Symbol	Values			Unit
		min.	typ.	max.	
AC characteristics (verified by random sampling)					
Transition frequency $I_C = 25\text{ mA}$, $V_{CE} = 8\text{ V}$, $f = 500\text{ MHz}$	f_T	6	8	-	GHz
Collector-base capacitance $V_{CB} = 10\text{ V}$, $f = 1\text{ MHz}$	C_{cb}	-	0.4	0.6	pF
Collector-emitter capacitance $V_{CE} = 10\text{ V}$, $f = 1\text{ MHz}$	C_{ce}	-	0.18	-	
Emitter-base capacitance $V_{EB} = 0.5\text{ V}$, $f = 1\text{ MHz}$	C_{eb}	-	1	-	
Noise figure $I_C = 5\text{ mA}$, $V_{CE} = 8\text{ V}$, $Z_S = Z_{Sopt}$, $f = 900\text{ MHz}$ $f = 1.8\text{ GHz}$	F	- -	1.2 2	- -	dB
Power gain, maximum stable ¹⁾ $I_C = 15\text{ mA}$, $V_{CE} = 8\text{ V}$, $Z_S = Z_{Sopt}$, $Z_L = Z_{Lopt}$, $f = 900\text{ MHz}$	G_{ms}	-	19.5	-	
Power gain, maximum available ²⁾ $I_C = 15\text{ mA}$, $V_{CE} = 8\text{ V}$, $Z_S = Z_{Sopt}$, $Z_L = Z_{Lopt}$, $f = 1.8\text{ GHz}$	G_{ma}	-	12.5	-	
Transducer gain $I_C = 15\text{ mA}$, $V_{CE} = 8\text{ V}$, $Z_S = Z_L = 50\Omega$, $f = 900\text{ MHz}$ $f = 1.8\text{ GHz}$	$ S_{21e} ^2$	- -	15.5 10	- -	

$$^1G_{ms} = |S_{21} / S_{12}|$$

$$^2G_{ma} = |S_{21} / S_{12}| (k - (k^2 - 1)^{1/2})$$

Total power dissipation $P_{tot} = f(T_S)$

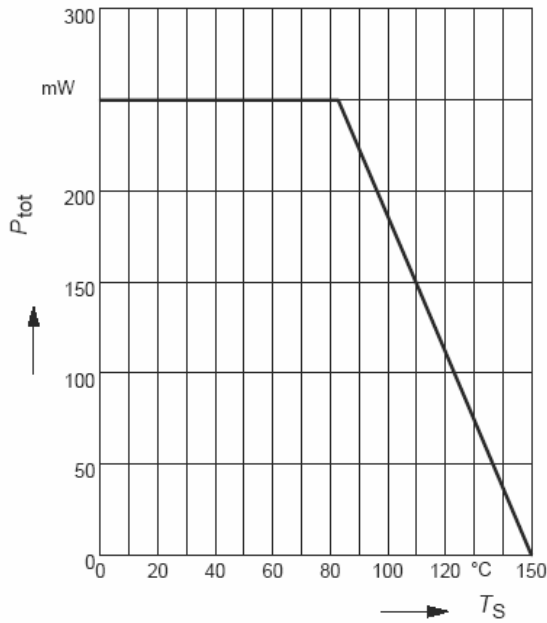

Permissible Pulse Load $R_{thJS} = f(t_p)$

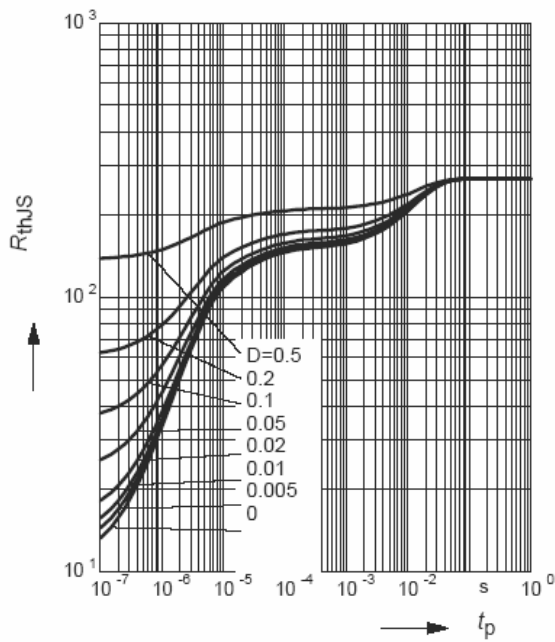

Permissible Pulse Load

$P_{totmax}/P_{totDC} = f(t_p)$

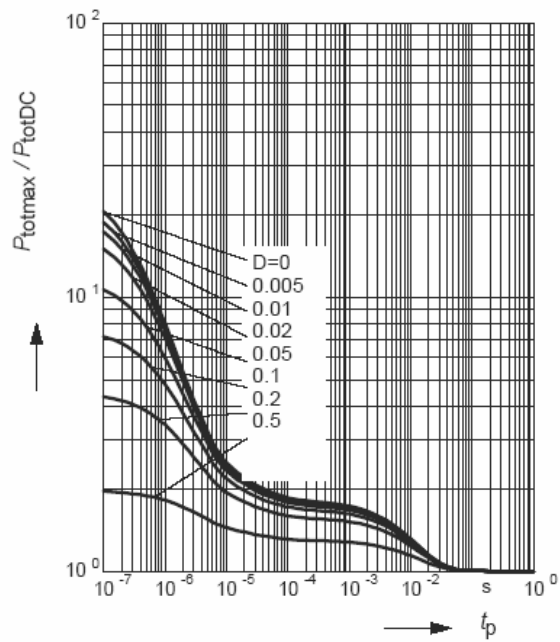

M A T183T

This item can replace **BFR183T**

Collector-base capacitance $C_{cb} = f(V_{CB})$
 $f = 1\text{MHz}$

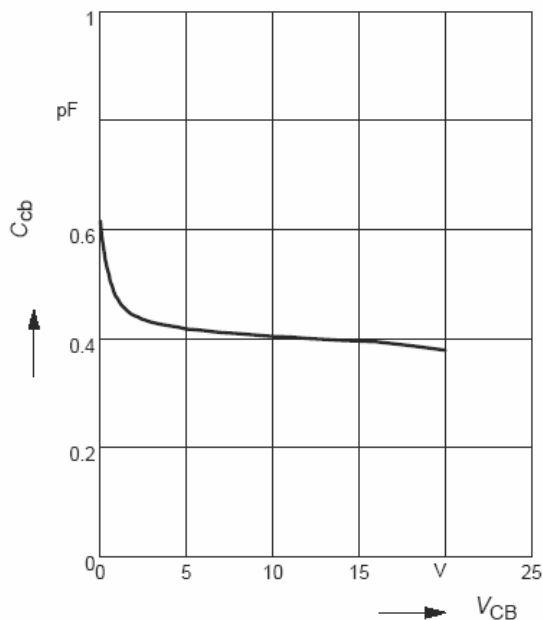

Transition frequency $f_T = f(I_C)$

$V_{CE} = \text{Parameter}$

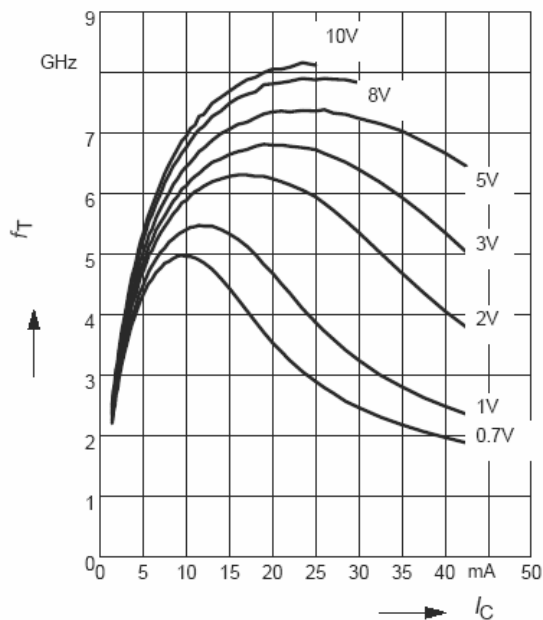

Power Gain $G_{ma}, G_{ms} = f(I_C)$

$f = 0.9\text{GHz}$

$V_{CE} = \text{Parameter}$

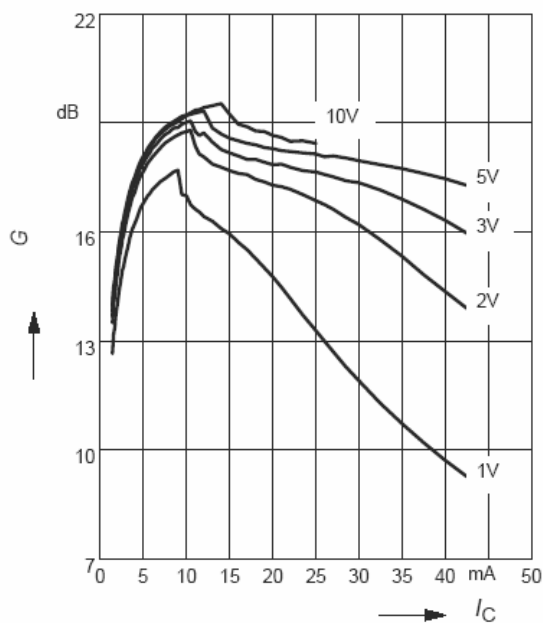

Power Gain $G_{ma}, G_{ms} = f(I_C)$

$f = 1.8\text{GHz}$

$V_{CE} = \text{Parameter}$

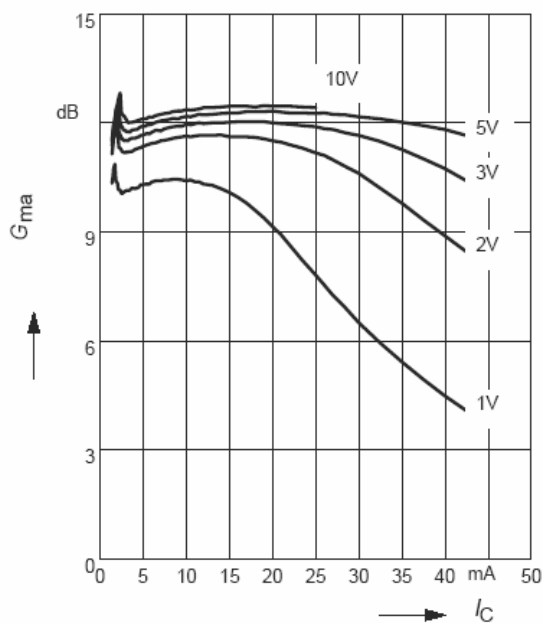

M A T183T

This item can replace **BFR183T**

Power Gain $G_{ma}, G_{ms} = f(V_{CE})$: _____
 $|S_{21}|^2 = f(V_{CE})$: - - - - -

f = Parameter

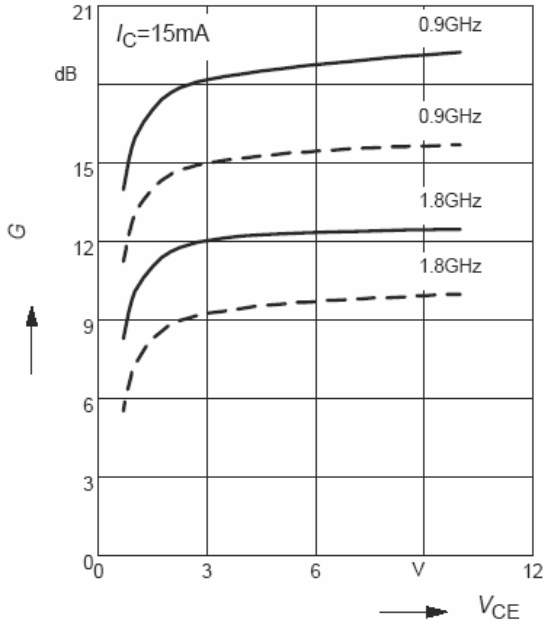

Intermodulation Intercept Point $IP_3 = f(I_C)$
 (3rd order, Output, $Z_S = Z_L = 50\Omega$)

V_{CE} = Parameter, $f = 900\text{MHz}$

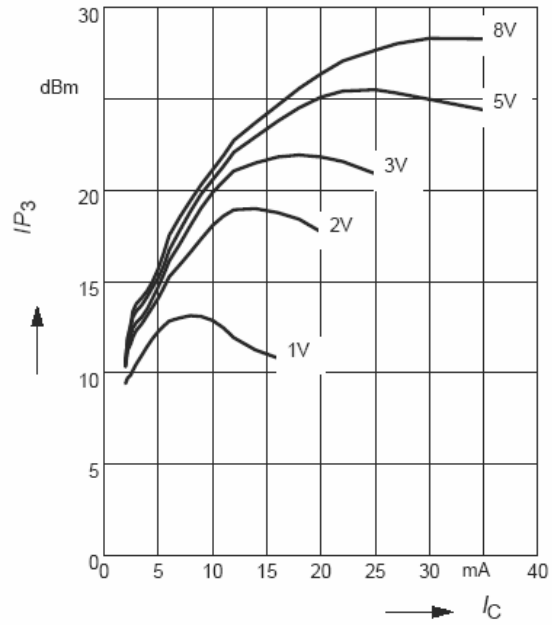

Power Gain $G_{ma}, G_{ms} = f(f)$

V_{CE} = Parameter

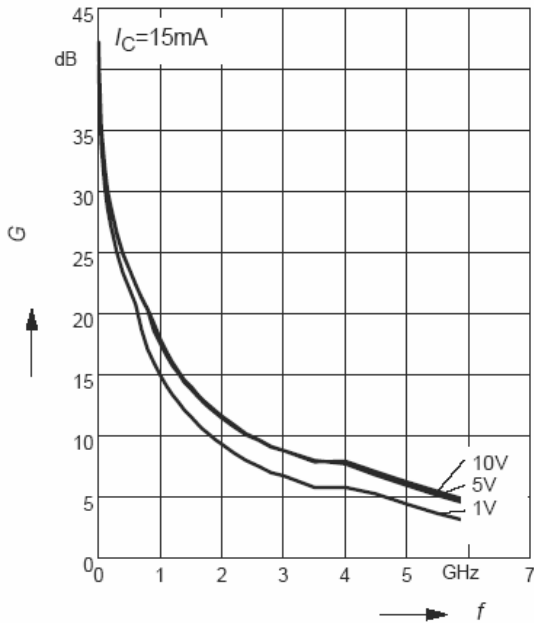

Power Gain $|S_{21}|^2 = f(f)$

V_{CE} = Parameter

