

HSG1002

SiGeHBT High Frequency Low Noise Amplifier

REJ03G0196-0100Z
Rev.1.00
Apr.12.2004

Features

- High power gain and low noise figure ;
- MSG = 21 dB typ. , NF = 0.7 dB typ. at $V_{CE} = 2\text{ V}, I_C = 5\text{ mA}, f = 1.8\text{ GHz}$
MSG = 20 dB typ. , NF = 0.8 dB typ. at $V_{CE} = 2\text{ V}, I_C = 5\text{ mA}, f = 2.4\text{ GHz}$
MSG = 16 dB typ. , NF = 1.2 dB typ. at $V_{CE} = 2\text{ V}, I_C = 10\text{ mA}, f = 5.8\text{ GHz}$
- Transition Frequency
 $f_T = 38\text{ GHz}$ typ. at $f = 1\text{ GHz}$
- $V_{CEO} = 3.5\text{ V}$
- Ideal for 2.4 GHz / 5 GHz Band WLAN and Cordless phone applications.

Outline

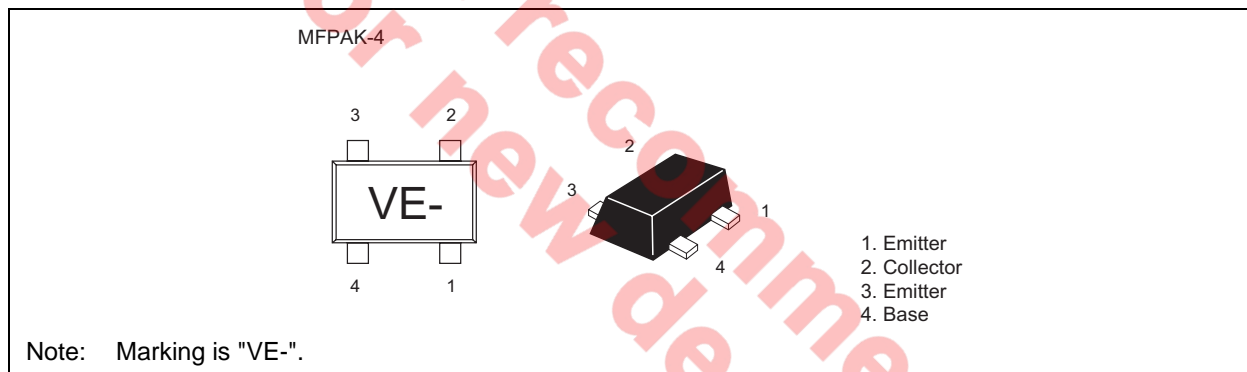

Absolute Maximum Ratings

($T_a = 25^\circ\text{C}$)

Item	Symbol	Ratings	Unit
Collector to base voltage	V_{CBO}	8	V
Collector to emitter voltage	V_{CEO}	3.5	V
Emitter to base voltage	V_{EBO}	1.2	V
Collector current	I_C	35	mA
Collector power dissipation	P_C	80	mW
	P_C^{note1}	200	mW
Junction temperature	T_j	150	$^\circ\text{C}$
Storage temperature	T_{stg}	-55 to +150	$^\circ\text{C}$

Notes: 1. Value on PCB (FR-4 : 40 x 40 x 1.6mm Double side)

Electrical Characteristics

(Ta = 25°C)

Item	Symbol	Min	Typ	Max	Unit	Test conditions
DC current transfer ratio	h_{FE}	100	200	300	—	$V_{CE} = 2\text{ V}$, $I_C = 5\text{ mA}$
Reverse Transfer Capacitance	C_{re}	—	0.09	—	pF	$V_{CB} = 2\text{ V}$, $I_E = 0$, $f = 1\text{ MHz}$
Transition Frequency	f_T	—	38	—	GHz	$V_{CE} = 2\text{ V}$, $I_C = f_T\text{ peak}$, $f = 1\text{ GHz}$
Insertion power gain	$ S_{21} ^2$	—	18.5	—	dB	$V_{CE} = 2\text{ V}$, $I_C = 5\text{ mA}$, $f = 1.8\text{ GHz}$
		—	16.5	—		$V_{CE} = 2\text{ V}$, $I_C = 5\text{ mA}$, $f = 2.4\text{ GHz}$
		—	11	—		$V_{CE} = 2\text{ V}$, $I_C = 10\text{ mA}$, $f = 5.8\text{ GHz}$
Maximum Stable Gain ^{note1}	MSG	—	21	—	dB	$V_{CE} = 2\text{ V}$, $I_C = 5\text{ mA}$, $f = 1.8\text{ GHz}$
		—	20	—		$V_{CE} = 2\text{ V}$, $I_C = 5\text{ mA}$, $f = 2.4\text{ GHz}$
		—	16	—		$V_{CE} = 2\text{ V}$, $I_C = 10\text{ mA}$, $f = 5.8\text{ GHz}$
Power Gain	PG	—	19.5	—	dB	$V_{CE} = 2\text{ V}$, $I_C = 5\text{ mA}$, $f = 1.8\text{ GHz}$
		—	17.5	—		$V_{CE} = 2\text{ V}$, $I_C = 5\text{ mA}$, $f = 2.4\text{ GHz}$
		8	11	—		$V_{CE} = 2\text{ V}$, $I_C = 10\text{ mA}$, $f = 5.8\text{ GHz}$
Noise figure	NF	—	0.7	—	dB	$V_{CE} = 2\text{ V}$, $I_C = 5\text{ mA}$, $f = 1.8\text{ GHz}$
		—	0.8	—		$V_{CE} = 2\text{ V}$, $I_C = 5\text{ mA}$, $f = 2.4\text{ GHz}$
		—	1.2	1.8		$V_{CE} = 2\text{ V}$, $I_C = 10\text{ mA}$, $f = 5.8\text{ GHz}$
Maximum Available Gain ^{note2}	MAG	—	13	—	dB	$V_{CE} = 2\text{ V}$, $I_C = 10\text{ mA}$, $f = 5.8\text{ GHz}$

Notes: 1. $MSG = |S_{21}| / |S_{12}|$
 2. $MAG = |S_{21}| / |S_{12}| (K - (K^2 - 1)^{1/2})$

Main Characteristics

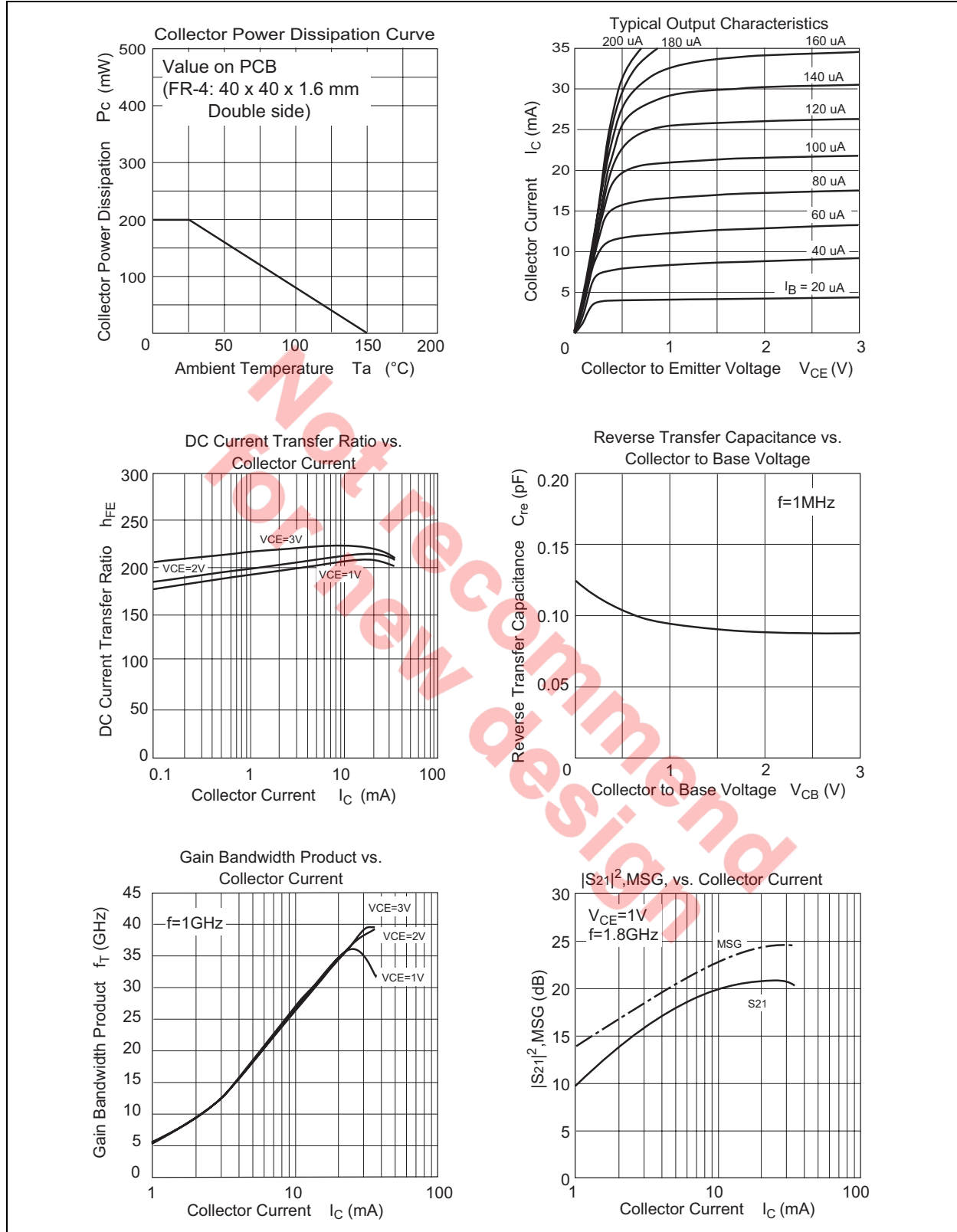

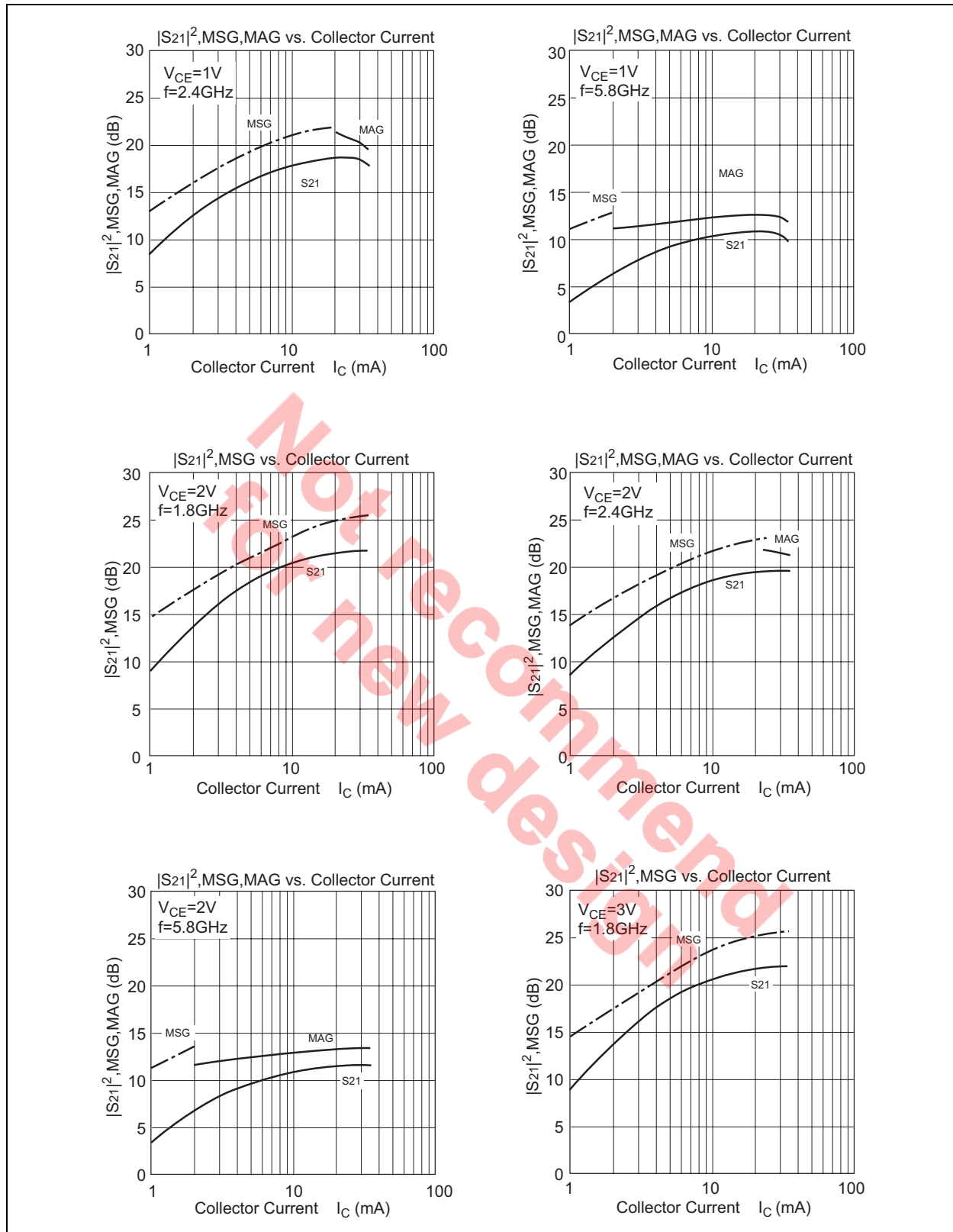

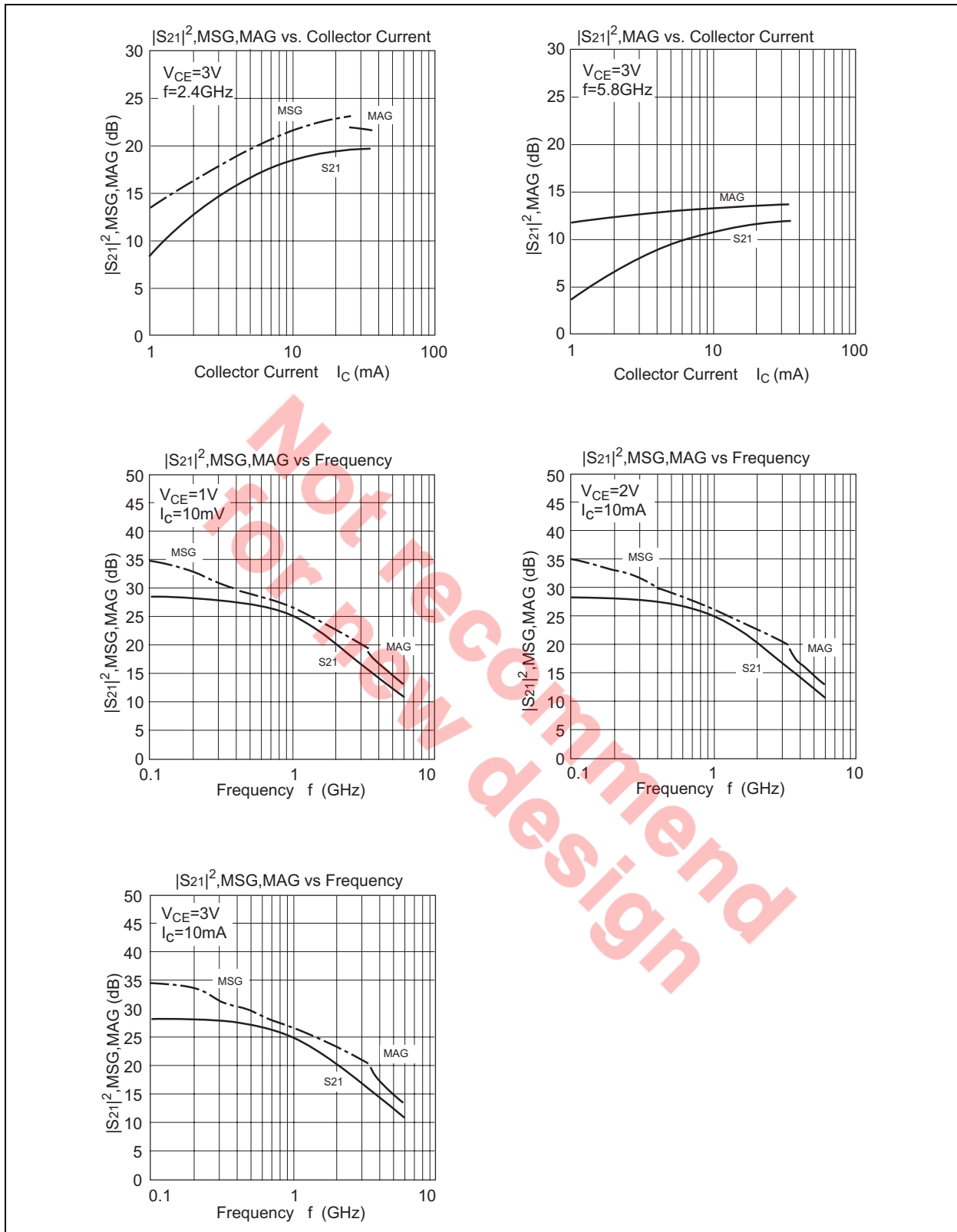

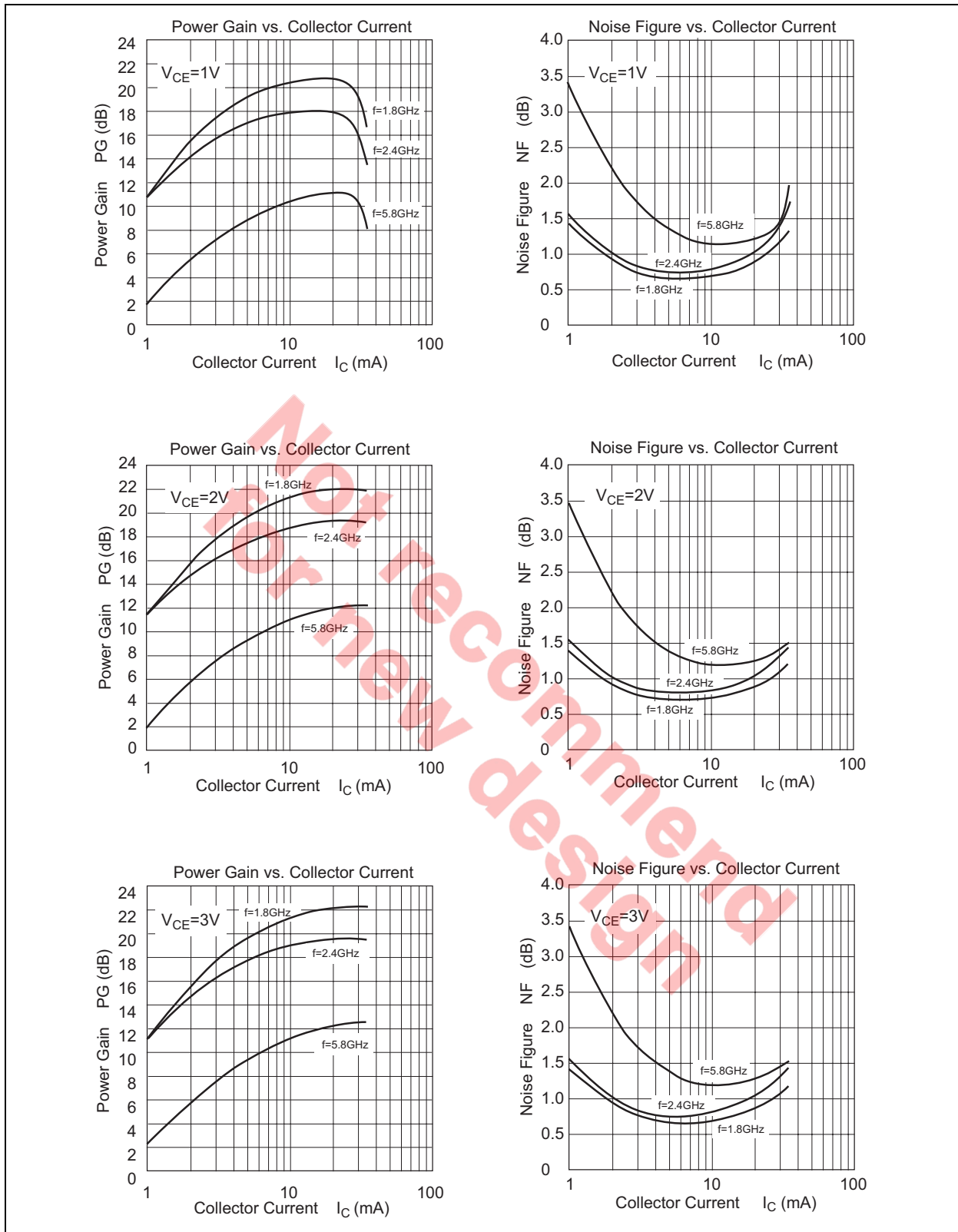

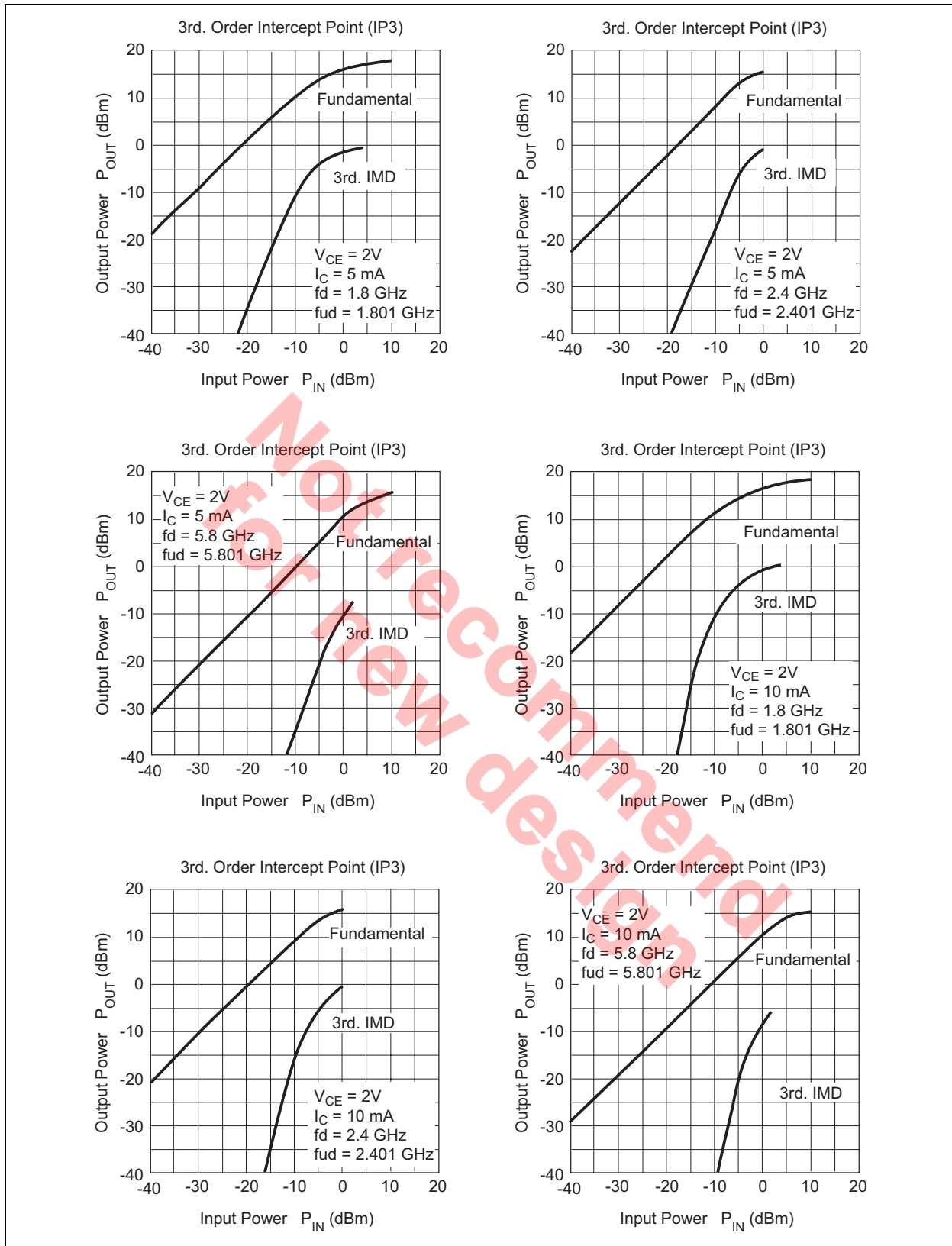

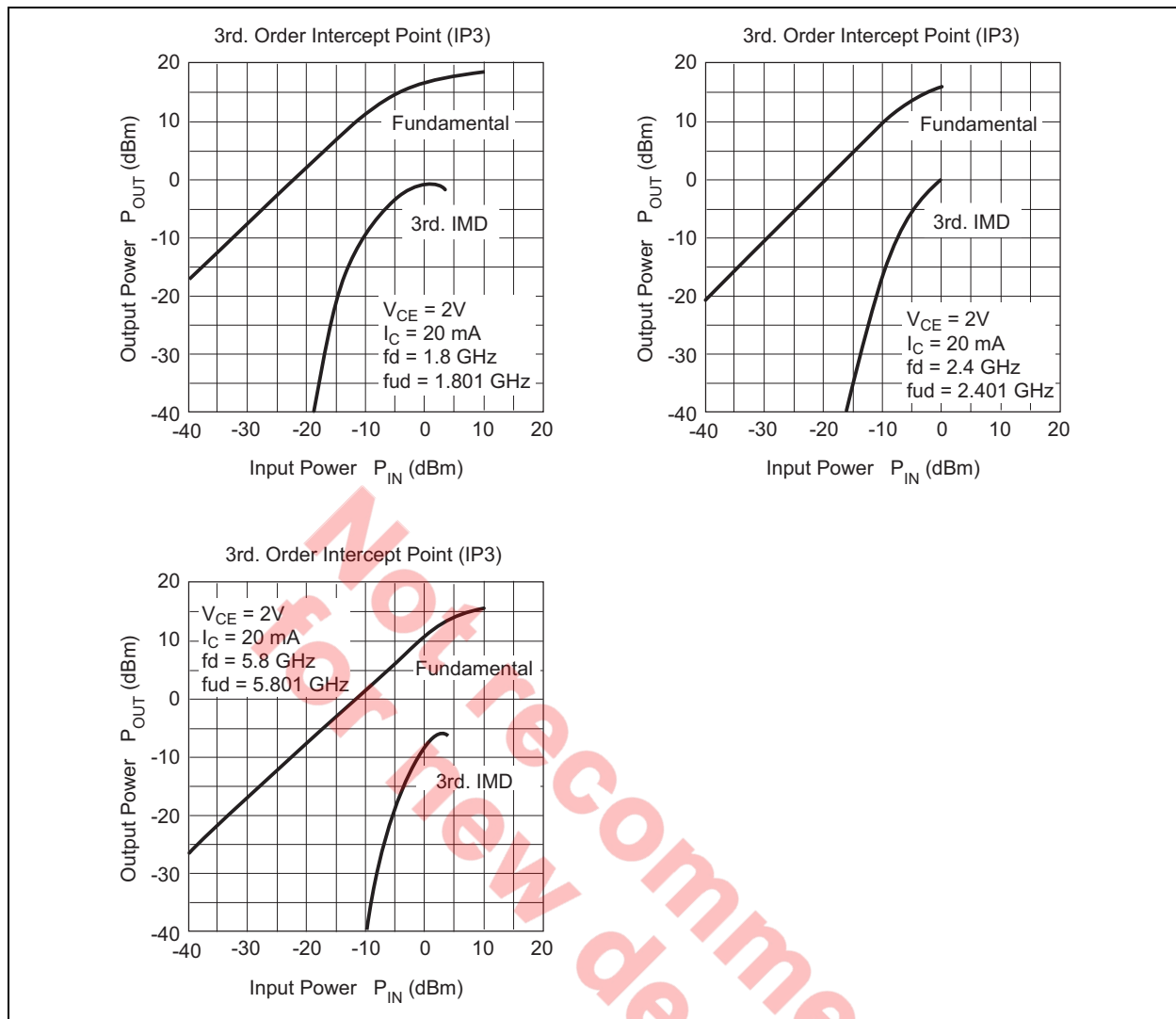

S₁₁ Parameter vs. Frequency

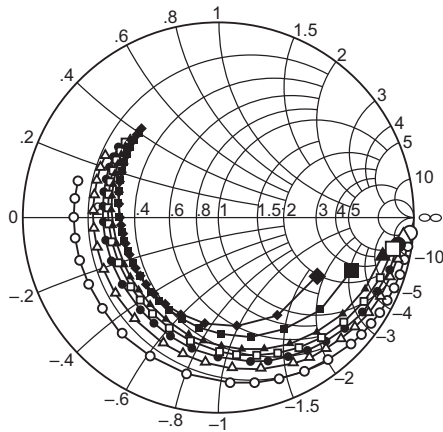

Condition: VCE = 1 V , Zo = 50 Ω
 100 to 1000 MHz (100 MHz step)
 1000 to 2000 MHz (200 MHz step)
 2000 to 6000 MHz (400 MHz step)

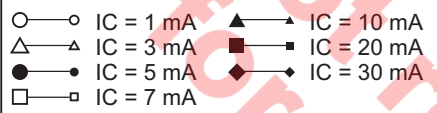

S₂₁ Parameter vs. Frequency

Scale: 15 / div.

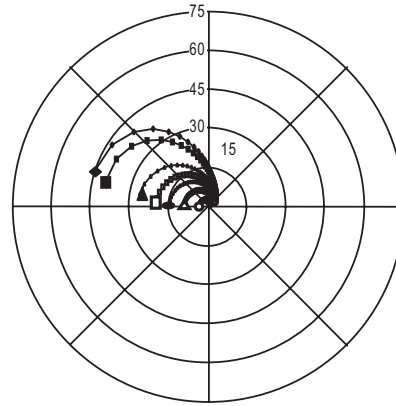

Condition: VCE = 1 V , Zo = 50 Ω
 100 to 6000 MHz (100 MHz step)



S₁₂ Parameter vs. Frequency

Scale: 0.1 / div.

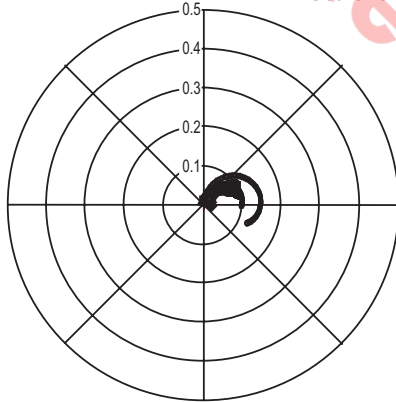

Condition: VCE = 1 V , Zo = 50 Ω
 100 to 6000 MHz (100 MHz step)



S₂₂ Parameter vs. Frequency

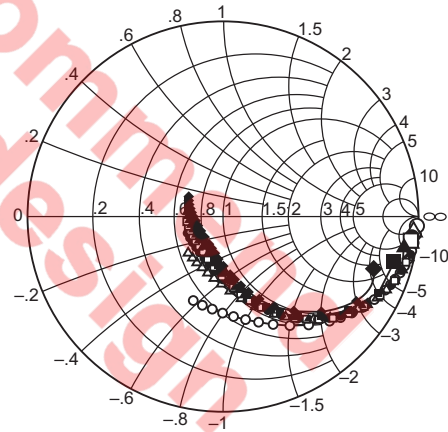

Condition: VCE = 1 V , Zo = 50 Ω
 100 to 1000 MHz (100 MHz step)
 1000 to 2000 MHz (200 MHz step)
 2000 to 6000 MHz (400 MHz step)

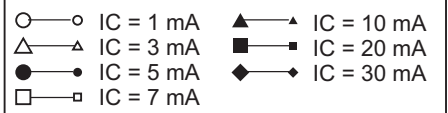

S₁₁ Parameter vs. Frequency

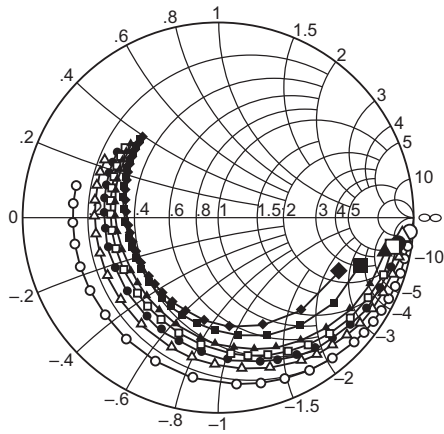

Condition: VCE = 2 V , Zo = 50 Ω
 100 to 1000 MHz (100 MHz step)
 1000 to 2000 MHz (200 MHz step)
 2000 to 6000 MHz (400 MHz step)

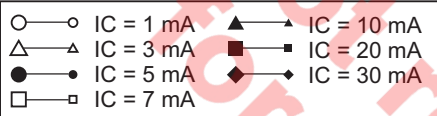

S₂₁ Parameter vs. Frequency

Scale: 15 / div.

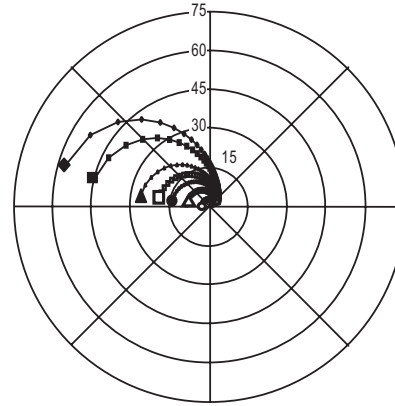

Condition: VCE = 2 V , Zo = 50 Ω
 100 to 6000 MHz (100 MHz step)



S₁₂ Parameter vs. Frequency

Scale: 0.1 / div.

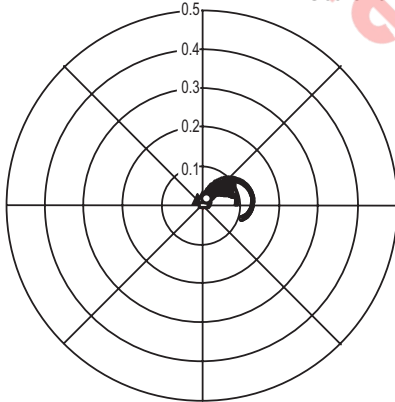

Condition: VCE = 2 V , Zo = 50 Ω
 100 to 6000 MHz (100 MHz step)



S₂₂ Parameter vs. Frequency

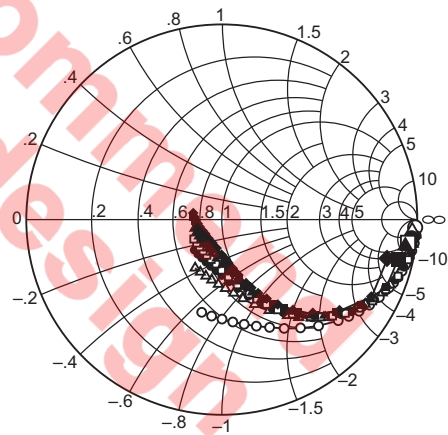

Condition: VCE = 2 V , Zo = 50 Ω
 100 to 1000 MHz (100 MHz step)
 1000 to 2000 MHz (200 MHz step)
 2000 to 6000 MHz (400 MHz step)



S₁₁ Parameter vs. Frequency

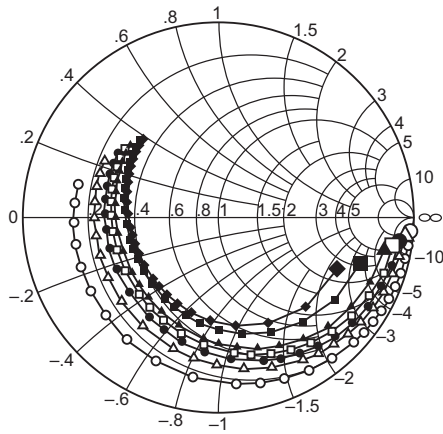

Condition: VCE = 3 V , Zo = 50 Ω
 100 to 1000 MHz (100 MHz step)
 1000 to 2000 MHz (200 MHz step)
 2000 to 6000 MHz (400 MHz step)

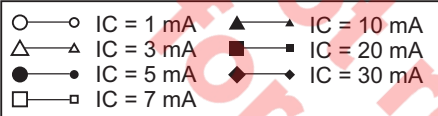

S₂₁ Parameter vs. Frequency

Scale: 15 / div.

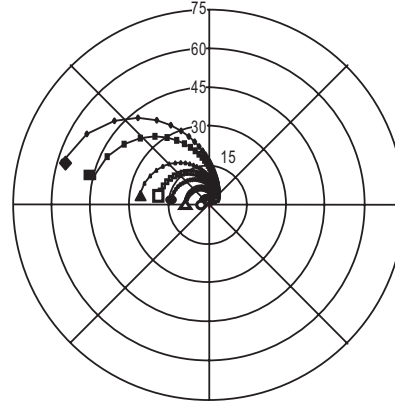

Condition: VCE = 3 V , Zo = 50 Ω
 100 to 6000 MHz (100 MHz step)



S₁₂ Parameter vs. Frequency

Scale: 0.1 / div.

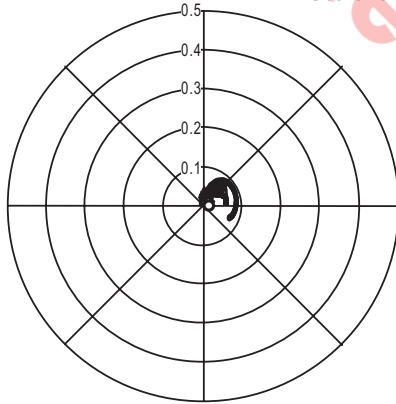

Condition: VCE = 3 V , Zo = 50 Ω
 100 to 6000 MHz (100 MHz step)



S₂₂ Parameter vs. Frequency

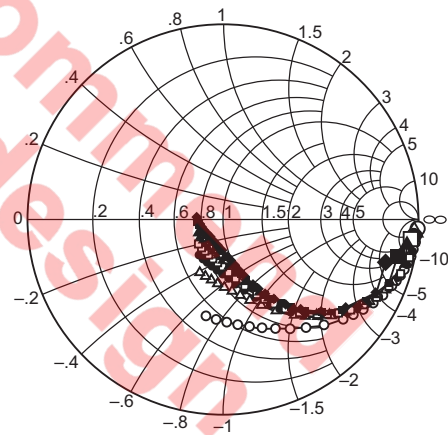

Condition: VCE = 3 V , Zo = 50 Ω
 100 to 1000 MHz (100 MHz step)
 1000 to 2000 MHz (200 MHz step)
 2000 to 6000 MHz (400 MHz step)



S Parameter

 $(V_{CE} = 1 \text{ V}, I_C = 1 \text{ mA}, Z_O = 50 \Omega)$

f (MHz)	S11		S21		S12		S22	
	MAG	ANG	MAG	ANG	MAG	ANG	MAG	ANG
100	0.982	-4.8	3.19	176.1	0.0067	74.5	0.995	-2.8
200	0.981	-8.9	3.19	172.0	0.0174	90.3	0.994	-5.4
300	0.976	-12.9	3.18	168.2	0.0226	77.2	0.987	-7.9
400	0.974	-17.7	3.18	165.0	0.0326	80.7	0.981	-10.3
500	0.969	-22.1	3.18	161.4	0.0383	75.7	0.973	-12.9
600	0.963	-26.4	3.16	158.3	0.0475	71.9	0.962	-15.3
700	0.960	-30.7	3.11	154.7	0.0555	68.5	0.950	-17.7
800	0.953	-35.0	3.08	151.3	0.0613	65.6	0.937	-20.0
900	0.948	-39.5	3.09	148.9	0.0693	62.7	0.925	-22.2
1000	0.940	-43.8	3.07	145.0	0.0749	59.5	0.911	-24.4
1100	0.930	-48.1	3.04	141.9	0.0809	56.6	0.897	-26.6
1200	0.921	-52.5	3.03	138.2	0.0883	53.9	0.883	-28.8
1300	0.913	-56.7	2.97	135.1	0.0924	51.9	0.868	-30.9
1400	0.905	-60.9	2.93	132.1	0.0985	48.9	0.855	-32.9
1500	0.896	-65.2	2.90	129.1	0.1043	46.2	0.839	-35.0
1600	0.885	-69.5	2.88	125.9	0.1084	43.9	0.823	-36.9
1700	0.877	-73.7	2.84	123.0	0.1131	41.3	0.810	-38.8
1800	0.869	-77.7	2.79	120.0	0.1178	38.7	0.793	-40.7
1900	0.859	-81.7	2.74	117.1	0.1207	36.3	0.779	-42.7
2000	0.851	-86.0	2.71	114.3	0.1246	33.9	0.764	-44.5
2200	0.836	-93.7	2.61	108.6	0.1311	29.4	0.736	-48.1
2400	0.820	-101.5	2.53	103.2	0.1352	24.9	0.707	-51.7
2600	0.806	-108.9	2.44	98.1	0.1390	20.6	0.678	-55.2
2800	0.794	-116.1	2.35	93.0	0.1420	16.7	0.655	-58.5
3000	0.781	-123.0	2.27	88.0	0.1444	13.0	0.632	-61.7
3200	0.773	-129.6	2.18	83.3	0.1458	9.5	0.609	-65.1
3400	0.764	-135.8	2.09	78.7	0.1453	6.1	0.590	-68.3
3600	0.756	-141.7	2.01	74.4	0.1455	2.5	0.571	-71.4
3800	0.752	-147.2	1.94	70.3	0.1439	-0.3	0.554	-74.6
4000	0.748	-152.6	1.86	66.2	0.1432	-3.1	0.540	-77.7
4200	0.745	-157.8	1.80	62.3	0.1416	-5.7	0.527	-80.8
4400	0.744	-162.6	1.73	58.4	0.1397	-8.2	0.515	-84.0
4600	0.742	-167.2	1.67	54.7	0.1377	-10.4	0.504	-87.1
4800	0.741	-171.6	1.61	51.1	0.1359	-12.8	0.495	-90.3
5000	0.740	-175.8	1.56	47.5	0.1324	-14.9	0.486	-93.3
5200	0.740	-179.9	1.51	44.1	0.1306	-16.7	0.477	-96.6
5400	0.741	176.3	1.45	40.8	0.1278	-18.8	0.472	-99.8
5600	0.741	172.6	1.41	37.5	0.1246	-20.1	0.467	-103.1
5800	0.741	169.1	1.36	34.2	0.1216	-21.8	0.461	-106.2
6000	0.742	165.6	1.32	31.1	0.1183	-22.9	0.456	-109.5

S Parameter

 $(V_{CE} = 1 \text{ V}, I_C = 3 \text{ mA}, Z_O = 50 \Omega)$

f (MHz)	S11		S21		S12		S22	
	MAG	ANG	MAG	ANG	MAG	ANG	MAG	ANG
100	0.951	-6.4	9.16	174.4	0.0116	85.3	0.980	-4.9
200	0.948	-13.2	9.12	169.0	0.0161	84.5	0.988	-8.6
300	0.934	-19.1	9.02	164.0	0.0224	78.1	0.974	-12.6
400	0.927	-26.0	8.91	159.2	0.0308	76.1	0.958	-16.6
500	0.915	-32.4	8.80	154.6	0.0379	68.2	0.939	-20.6
600	0.900	-38.7	8.65	150.3	0.0447	68.3	0.917	-24.3
700	0.887	-44.7	8.40	146.0	0.0511	61.3	0.892	-28.0
800	0.872	-50.6	8.21	141.8	0.0563	57.0	0.865	-31.5
900	0.859	-56.8	8.13	138.3	0.0627	55.3	0.838	-34.6
1000	0.841	-62.6	7.91	134.0	0.0660	52.6	0.809	-37.7
1100	0.825	-68.2	7.70	130.3	0.0712	48.6	0.784	-40.7
1200	0.805	-74.1	7.54	126.3	0.0735	46.1	0.756	-43.5
1300	0.790	-79.3	7.29	122.8	0.0777	43.4	0.728	-46.2
1400	0.776	-84.5	7.06	119.6	0.0811	41.3	0.703	-48.9
1500	0.761	-89.7	6.88	116.3	0.0843	38.2	0.677	-51.4
1600	0.746	-94.8	6.69	113.0	0.0860	36.0	0.653	-53.6
1700	0.734	-99.6	6.48	110.0	0.0889	33.2	0.630	-56.0
1800	0.722	-104.2	6.27	107.1	0.0905	31.7	0.607	-58.2
1900	0.711	-108.7	6.08	104.2	0.0918	29.8	0.585	-60.4
2000	0.702	-113.2	5.90	101.5	0.0934	27.8	0.564	-62.4
2200	0.685	-121.3	5.53	96.3	0.0953	24.6	0.526	-66.4
2400	0.671	-129.2	5.21	91.4	0.0969	21.6	0.491	-70.2
2600	0.661	-136.5	4.91	86.9	0.0981	18.7	0.459	-74.1
2800	0.652	-143.2	4.63	82.5	0.0994	16.3	0.432	-77.6
3000	0.645	-149.5	4.37	78.4	0.0995	13.8	0.407	-81.0
3200	0.641	-155.3	4.13	74.5	0.0992	12.4	0.384	-84.7
3400	0.637	-160.8	3.91	70.7	0.0998	10.5	0.366	-88.1
3600	0.634	-165.9	3.71	67.2	0.0992	8.6	0.347	-91.4
3800	0.633	-170.5	3.53	63.8	0.0983	7.9	0.332	-94.8
4000	0.635	-174.8	3.37	60.5	0.0983	6.5	0.321	-98.2
4200	0.635	-179.1	3.22	57.3	0.0977	5.7	0.310	-101.7
4400	0.637	176.9	3.08	54.1	0.0976	4.4	0.301	-105.2
4600	0.639	173.3	2.95	51.1	0.0971	3.9	0.292	-108.7
4800	0.640	169.8	2.83	48.1	0.0974	2.6	0.284	-112.1
5000	0.644	166.4	2.71	45.2	0.0963	2.5	0.278	-115.7
5200	0.646	163.0	2.61	42.3	0.0963	1.8	0.273	-119.4
5400	0.648	160.0	2.51	39.5	0.0964	1.1	0.269	-122.9
5600	0.651	157.0	2.42	36.7	0.0956	0.8	0.264	-126.2
5800	0.652	154.1	2.34	33.9	0.0957	0.1	0.262	-129.7
6000	0.655	151.3	2.26	31.2	0.0958	-0.2	0.259	-133.5

S Parameter

 $(V_{CE} = 1 \text{ V}, I_C = 5 \text{ mA}, Z_O = 50 \Omega)$

f (MHz)	S11		S21		S12		S22	
	MAG	ANG	MAG	ANG	MAG	ANG	MAG	ANG
100	0.928	-8.7	14.65	172.9	0.0098	74.4	0.973	-6.2
200	0.916	-17.1	14.50	166.3	0.0149	80.3	0.979	-11.4
300	0.897	-25.0	14.21	160.1	0.0215	71.6	0.954	-16.8
400	0.882	-33.4	13.88	154.4	0.0296	71.0	0.929	-22.1
500	0.861	-41.4	13.54	149.0	0.0350	65.3	0.898	-27.1
600	0.840	-49.2	13.15	143.9	0.0418	60.4	0.865	-31.6
700	0.820	-56.3	12.62	139.1	0.0471	56.5	0.828	-36.2
800	0.798	-63.5	12.18	134.3	0.0511	53.2	0.789	-40.3
900	0.779	-71.0	11.86	130.2	0.0550	49.5	0.751	-44.0
1000	0.757	-77.5	11.38	125.8	0.0587	46.8	0.715	-47.5
1100	0.736	-83.7	10.90	121.8	0.0606	45.0	0.682	-50.8
1200	0.716	-90.2	10.51	117.9	0.0642	41.7	0.649	-53.8
1300	0.699	-95.8	10.05	114.3	0.0664	39.1	0.616	-56.8
1400	0.685	-101.4	9.62	111.1	0.0679	38.5	0.588	-59.6
1500	0.670	-106.7	9.24	107.9	0.0704	35.3	0.559	-62.3
1600	0.656	-112.0	8.87	104.8	0.0719	33.7	0.533	-64.6
1700	0.645	-116.7	8.51	102.0	0.0729	32.2	0.509	-67.1
1800	0.636	-121.3	8.16	99.3	0.0742	30.7	0.486	-69.4
1900	0.627	-125.8	7.84	96.6	0.0751	29.6	0.464	-71.7
2000	0.620	-130.1	7.54	94.2	0.0760	28.4	0.445	-73.9
2200	0.609	-137.7	6.98	89.5	0.0770	26.2	0.409	-78.2
2400	0.601	-145.0	6.49	85.1	0.0781	24.1	0.376	-82.2
2600	0.595	-151.7	6.06	81.0	0.0790	22.1	0.347	-86.4
2800	0.592	-157.8	5.67	77.2	0.0804	21.5	0.324	-90.3
3000	0.589	-163.3	5.32	73.5	0.0817	20.0	0.303	-94.3
3200	0.589	-168.5	5.00	70.0	0.0816	19.1	0.285	-98.6
3400	0.589	-173.3	4.72	66.7	0.0822	17.8	0.269	-102.7
3600	0.589	-177.7	4.46	63.6	0.0822	16.9	0.254	-106.7
3800	0.590	178.4	4.23	60.6	0.0832	16.9	0.244	-110.5
4000	0.593	174.5	4.02	57.6	0.0840	16.2	0.235	-114.6
4200	0.597	170.8	3.83	54.7	0.0851	15.6	0.228	-119.0
4400	0.600	167.5	3.65	51.8	0.0858	15.4	0.221	-123.2
4600	0.604	164.3	3.49	49.1	0.0868	14.7	0.216	-127.3
4800	0.606	161.2	3.35	46.4	0.0876	14.2	0.212	-131.4
5000	0.609	158.3	3.21	43.7	0.0889	13.7	0.208	-135.4
5200	0.613	155.3	3.08	41.1	0.0900	13.6	0.206	-139.8
5400	0.616	152.7	2.97	38.5	0.0910	13.1	0.204	-143.5
5600	0.620	150.0	2.86	35.9	0.0915	12.8	0.203	-147.4
5800	0.622	147.4	2.76	33.4	0.0926	12.0	0.203	-151.3
6000	0.625	144.9	2.66	30.9	0.0941	11.9	0.202	-155.2

S Parameter

 $(V_{CE} = 1 \text{ V}, I_C = 7 \text{ mA}, Z_O = 50 \Omega)$

f (MHz)	S11		S21		S12		S22	
	MAG	ANG	MAG	ANG	MAG	ANG	MAG	ANG
100	0.907	-10.4	19.70	171.6	0.0062	24.1	0.970	-7.3
200	0.884	-20.6	19.37	163.9	0.0158	79.8	0.965	-14.1
300	0.861	-30.2	18.82	156.8	0.0208	72.4	0.937	-20.6
400	0.837	-40.1	18.20	150.3	0.0290	68.5	0.900	-26.8
500	0.813	-49.5	17.54	144.3	0.0330	63.3	0.857	-32.6
600	0.786	-58.4	16.82	138.6	0.0389	57.9	0.812	-37.8
700	0.761	-66.5	15.96	133.4	0.0433	52.7	0.766	-42.9
800	0.735	-74.5	15.22	128.4	0.0465	49.6	0.720	-47.2
900	0.712	-82.5	14.57	123.9	0.0491	47.0	0.678	-51.0
1000	0.690	-89.5	13.82	119.6	0.0518	44.3	0.638	-54.8
1100	0.671	-96.1	13.10	115.7	0.0540	41.4	0.601	-58.3
1200	0.651	-102.7	12.47	111.8	0.0559	40.5	0.565	-61.4
1300	0.635	-108.4	11.82	108.4	0.0572	38.4	0.534	-64.4
1400	0.623	-113.8	11.22	105.3	0.0595	36.6	0.505	-67.2
1500	0.610	-119.3	10.69	102.3	0.0608	35.5	0.477	-70.0
1600	0.600	-124.2	10.18	99.5	0.0616	34.3	0.452	-72.4
1700	0.592	-128.9	9.71	96.9	0.0633	32.4	0.428	-75.0
1800	0.584	-133.2	9.27	94.3	0.0634	31.9	0.407	-77.3
1900	0.578	-137.4	8.86	91.9	0.0650	31.1	0.387	-79.7
2000	0.574	-141.4	8.49	89.7	0.0655	30.8	0.369	-81.9
2200	0.567	-148.6	7.80	85.4	0.0671	28.7	0.337	-86.6
2400	0.562	-155.3	7.22	81.3	0.0683	27.8	0.309	-91.2
2600	0.561	-161.3	6.70	77.6	0.0695	26.2	0.283	-95.9
2800	0.560	-166.8	6.25	74.1	0.0709	26.0	0.264	-100.4
3000	0.561	-171.7	5.84	70.7	0.0733	25.9	0.247	-104.9
3200	0.563	-176.4	5.48	67.5	0.0734	25.0	0.232	-109.8
3400	0.566	179.2	5.16	64.4	0.0744	24.2	0.220	-114.8
3600	0.566	175.3	4.87	61.5	0.0752	23.6	0.209	-119.5
3800	0.569	171.7	4.61	58.8	0.0772	23.7	0.201	-123.9
4000	0.574	168.3	4.38	56.0	0.0790	23.3	0.196	-128.7
4200	0.578	165.0	4.17	53.2	0.0802	22.8	0.191	-133.7
4400	0.582	162.0	3.98	50.6	0.0817	22.2	0.189	-138.5
4600	0.587	159.1	3.80	48.0	0.0836	22.2	0.186	-142.8
4800	0.589	156.3	3.64	45.4	0.0847	21.7	0.184	-147.4
5000	0.594	153.6	3.49	42.9	0.0870	21.3	0.184	-151.4
5200	0.598	150.9	3.35	40.4	0.0886	20.8	0.183	-156.1
5400	0.602	148.4	3.22	37.9	0.0911	20.2	0.184	-160.0
5600	0.605	146.1	3.10	35.5	0.0920	19.9	0.184	-163.9
5800	0.609	143.6	2.99	33.0	0.0941	19.0	0.186	-167.9
6000	0.612	141.2	2.89	30.6	0.0958	18.8	0.187	-171.7

S Parameter

 $(V_{CE} = 1 \text{ V}, I_C = 10 \text{ mA}, Z_O = 50 \Omega)$

f (MHz)	S11		S21		S12		S22	
	MAG	ANG	MAG	ANG	MAG	ANG	MAG	ANG
100	0.862	-13.3	26.51	169.9	0.0078	97.9	0.942	-10.0
200	0.841	-26.0	25.84	160.8	0.0125	66.3	0.950	-17.6
300	0.811	-37.8	24.78	152.5	0.0211	63.1	0.904	-25.5
400	0.779	-49.3	23.61	145.1	0.0253	62.7	0.849	-32.8
500	0.747	-60.2	22.36	138.3	0.0312	57.4	0.796	-39.4
600	0.716	-70.5	21.06	132.2	0.0348	54.7	0.740	-45.1
700	0.688	-79.6	19.67	126.7	0.0386	50.2	0.685	-50.4
800	0.661	-88.2	18.45	121.6	0.0402	47.3	0.635	-55.0
900	0.638	-96.5	17.34	117.1	0.0431	43.8	0.590	-59.1
1000	0.619	-103.7	16.22	112.9	0.0445	44.0	0.548	-62.8
1100	0.602	-110.2	15.20	109.2	0.0468	41.1	0.511	-66.4
1200	0.586	-116.8	14.30	105.7	0.0473	39.9	0.477	-69.5
1300	0.574	-122.2	13.44	102.6	0.0496	38.6	0.446	-72.5
1400	0.565	-127.5	12.67	99.7	0.0510	37.6	0.420	-75.4
1500	0.556	-132.6	11.98	97.0	0.0516	37.2	0.394	-78.3
1600	0.550	-137.1	11.35	94.4	0.0531	36.0	0.371	-80.7
1700	0.545	-141.4	10.77	92.0	0.0534	35.5	0.351	-83.6
1800	0.541	-145.5	10.24	89.7	0.0542	35.2	0.332	-86.0
1900	0.538	-149.2	9.75	87.5	0.0558	34.8	0.315	-88.5
2000	0.536	-152.8	9.30	85.5	0.0571	34.5	0.299	-91.2
2200	0.534	-159.3	8.52	81.6	0.0587	33.1	0.272	-96.2
2400	0.534	-165.1	7.84	78.0	0.0605	33.0	0.250	-101.4
2600	0.534	-170.4	7.26	74.6	0.0621	32.6	0.230	-106.8
2800	0.537	-175.3	6.75	71.4	0.0638	32.9	0.215	-112.2
3000	0.540	-179.7	6.30	68.3	0.0655	31.3	0.202	-117.6
3200	0.545	176.1	5.90	65.3	0.0681	31.5	0.192	-123.6
3400	0.547	172.4	5.55	62.4	0.0691	31.1	0.184	-129.2
3600	0.550	168.7	5.23	59.7	0.0710	31.1	0.177	-134.8
3800	0.554	165.6	4.95	57.2	0.0737	31.0	0.173	-139.9
4000	0.559	162.6	4.70	54.5	0.0759	30.5	0.171	-145.0
4200	0.564	159.7	4.47	52.0	0.0785	29.8	0.170	-150.1
4400	0.569	157.0	4.26	49.4	0.0804	29.6	0.171	-155.1
4600	0.574	154.4	4.07	47.0	0.0820	28.7	0.171	-159.4
4800	0.577	151.8	3.89	44.6	0.0846	27.9	0.172	-163.8
5000	0.582	149.3	3.73	42.2	0.0871	27.3	0.174	-168.3
5200	0.587	146.9	3.58	39.8	0.0898	26.5	0.177	-172.4
5400	0.590	144.6	3.44	37.4	0.0912	26.2	0.179	-176.3
5600	0.594	142.4	3.31	35.1	0.0931	25.6	0.180	-179.9
5800	0.598	140.1	3.19	32.7	0.0953	24.5	0.184	176.5
6000	0.601	138.0	3.08	30.4	0.0983	23.6	0.186	173.0

S Parameter

 $(V_{CE} = 1 \text{ V}, I_C = 20 \text{ mA}, Z_O = 50 \Omega)$

f (MHz)	S11		S21		S12		S22	
	MAG	ANG	MAG	ANG	MAG	ANG	MAG	ANG
100	0.732	-21.9	40.28	165.4	0.0064	92.0	0.903	-14.9
200	0.701	-41.8	39.50	152.8	0.0140	69.2	0.886	-26.1
300	0.665	-59.5	37.24	141.9	0.0178	55.6	0.800	-36.9
400	0.633	-74.7	34.34	132.9	0.0226	59.5	0.716	-45.7
500	0.598	-88.3	31.10	125.2	0.0249	54.9	0.639	-53.2
600	0.573	-99.8	28.12	119.0	0.0263	49.6	0.571	-59.2
700	0.551	-109.5	25.40	113.8	0.0288	45.9	0.513	-64.4
800	0.536	-118.0	23.11	109.2	0.0297	45.7	0.464	-69.1
900	0.523	-125.4	21.14	105.3	0.0313	45.3	0.420	-72.9
1000	0.514	-131.9	19.38	101.9	0.0335	45.8	0.384	-76.6
1100	0.508	-137.6	17.88	98.8	0.0342	43.5	0.354	-80.1
1200	0.502	-143.0	16.58	96.0	0.0346	44.5	0.326	-83.1
1300	0.497	-147.5	15.42	93.5	0.0368	43.5	0.303	-86.4
1400	0.496	-151.7	14.41	91.1	0.0382	43.9	0.283	-89.5
1500	0.494	-155.7	13.53	88.9	0.0395	44.2	0.265	-92.5
1600	0.493	-159.3	12.73	86.8	0.0412	45.1	0.248	-95.5
1700	0.494	-162.5	12.01	84.9	0.0428	44.9	0.234	-98.9
1800	0.494	-165.6	11.37	83.0	0.0431	44.2	0.221	-101.7
1900	0.495	-168.5	10.79	81.2	0.0447	44.6	0.210	-105.0
2000	0.496	-171.2	10.26	79.5	0.0462	45.3	0.200	-108.2
2200	0.500	-176.1	9.34	76.3	0.0486	45.2	0.184	-114.7
2400	0.504	179.5	8.56	73.2	0.0511	44.5	0.172	-121.6
2600	0.509	175.5	7.90	70.2	0.0539	44.5	0.162	-128.6
2800	0.515	171.7	7.33	67.5	0.0566	44.9	0.156	-135.3
3000	0.520	168.3	6.83	64.8	0.0602	43.5	0.152	-142.4
3200	0.526	165.1	6.39	62.1	0.0627	43.2	0.151	-148.9
3400	0.532	162.0	6.00	59.5	0.0648	42.4	0.150	-155.1
3600	0.536	159.1	5.65	57.1	0.0680	41.7	0.149	-161.2
3800	0.540	156.7	5.34	54.8	0.0706	41.5	0.151	-165.5
4000	0.546	154.4	5.07	52.4	0.0737	40.7	0.155	-170.5
4200	0.552	152.0	4.81	50.1	0.0770	39.9	0.160	-174.9
4400	0.558	149.6	4.59	47.8	0.0800	39.0	0.163	-178.9
4600	0.564	147.5	4.38	45.5	0.0822	38.5	0.168	176.9
4800	0.566	145.3	4.19	43.3	0.0861	37.5	0.172	173.4
5000	0.572	143.1	4.02	41.0	0.0877	36.4	0.176	169.9
5200	0.577	141.0	3.85	38.8	0.0908	35.2	0.182	166.5
5400	0.580	139.1	3.70	36.5	0.0936	34.1	0.186	163.5
5600	0.585	137.1	3.57	34.4	0.0961	33.1	0.191	160.6
5800	0.588	135.1	3.44	32.1	0.0992	32.1	0.195	157.6
6000	0.592	133.1	3.32	29.9	0.1022	31.0	0.199	154.8

S Parameter

 $(V_{CE} = 1 \text{ V}, I_C = 30 \text{ mA}, Z_O = 50 \Omega)$

f (MHz)	S11		S21		S12		S22	
	MAG	ANG	MAG	ANG	MAG	ANG	MAG	ANG
100	0.589	-31.0	45.47	162.6	0.0154	91.0	0.816	-19.0
200	0.583	-58.7	43.68	147.4	0.0106	71.5	0.808	-32.4
300	0.561	-80.2	40.21	135.0	0.0161	57.9	0.700	-44.0
400	0.545	-97.1	36.32	125.4	0.0183	55.2	0.603	-53.0
500	0.531	-111.0	32.19	117.8	0.0201	50.7	0.527	-60.4
600	0.518	-121.5	28.79	112.0	0.0225	46.6	0.461	-66.2
700	0.509	-130.1	25.74	107.3	0.0246	48.0	0.407	-71.2
800	0.502	-137.2	23.30	103.3	0.0260	47.9	0.365	-75.4
900	0.496	-143.2	21.26	99.8	0.0260	48.0	0.327	-79.4
1000	0.495	-148.6	19.37	96.9	0.0279	48.0	0.298	-82.8
1100	0.493	-153.3	17.82	94.1	0.0297	48.3	0.274	-86.0
1200	0.491	-157.4	16.48	91.7	0.0307	48.5	0.252	-89.5
1300	0.490	-161.0	15.31	89.5	0.0326	49.5	0.234	-92.8
1400	0.492	-164.5	14.28	87.4	0.0337	50.5	0.218	-96.2
1500	0.492	-167.7	13.39	85.4	0.0349	50.7	0.204	-99.6
1600	0.493	-170.5	12.58	83.6	0.0370	50.3	0.191	-102.5
1700	0.495	-173.2	11.85	81.8	0.0388	50.6	0.181	-106.1
1800	0.497	-175.7	11.21	80.1	0.0400	50.2	0.172	-109.5
1900	0.499	-178.0	10.64	78.4	0.0413	50.4	0.164	-113.4
2000	0.502	179.8	10.11	76.9	0.0428	49.8	0.157	-116.8
2200	0.506	175.9	9.19	73.9	0.0459	50.6	0.147	-124.4
2400	0.512	172.0	8.42	71.0	0.0496	50.4	0.140	-132.1
2600	0.519	168.7	7.77	68.3	0.0524	50.1	0.135	-139.8
2800	0.525	165.5	7.21	65.6	0.0553	49.1	0.134	-147.3
3000	0.530	162.7	6.71	63.1	0.0580	49.2	0.132	-153.8
3200	0.536	159.8	6.28	60.5	0.0614	48.8	0.136	-160.4
3400	0.542	157.1	5.89	58.1	0.0640	47.6	0.138	-166.3
3600	0.546	154.7	5.54	55.8	0.0668	46.2	0.141	-171.7
3800	0.550	152.4	5.24	53.5	0.0700	46.8	0.145	-176.1
4000	0.557	150.2	4.98	51.2	0.0743	44.5	0.150	179.9
4200	0.562	148.1	4.73	48.9	0.0769	44.1	0.157	176.0
4400	0.568	146.0	4.51	46.7	0.0797	42.9	0.161	172.3
4600	0.573	144.1	4.30	44.5	0.0831	41.9	0.166	169.1
4800	0.577	142.1	4.11	42.3	0.0855	40.5	0.171	165.8
5000	0.582	140.0	3.94	40.1	0.0886	40.1	0.177	162.8
5200	0.588	138.1	3.78	37.9	0.0917	38.6	0.183	160.0
5400	0.591	136.2	3.64	35.7	0.0945	37.0	0.188	157.0
5600	0.595	134.4	3.50	33.5	0.0973	36.0	0.193	154.6
5800	0.598	132.5	3.38	31.4	0.1006	34.7	0.198	151.8
6000	0.602	130.6	3.26	29.2	0.1031	33.5	0.203	149.3

S Parameter

 $(V_{CE} = 2 \text{ V}, I_C = 1 \text{ mA}, Z_O = 50 \Omega)$

f (MHz)	S11		S21		S12		S22	
	MAG	ANG	MAG	ANG	MAG	ANG	MAG	ANG
100	0.982	-4.2	3.19	176.2	0.0056	113.6	0.988	-2.4
200	0.982	-8.6	3.20	172.3	0.0134	79.0	0.997	-4.8
300	0.977	-12.5	3.19	168.7	0.0191	79.4	0.991	-7.1
400	0.976	-17.0	3.18	165.5	0.0272	80.4	0.984	-9.4
500	0.973	-21.2	3.19	162.2	0.0334	75.6	0.977	-11.7
600	0.967	-25.5	3.17	159.1	0.0399	73.2	0.968	-13.8
700	0.961	-29.7	3.13	155.7	0.0473	69.4	0.958	-16.1
800	0.956	-33.8	3.10	152.4	0.0539	66.9	0.948	-18.2
900	0.951	-38.2	3.12	150.1	0.0582	63.3	0.936	-20.3
1000	0.944	-42.5	3.09	146.3	0.0655	61.3	0.924	-22.3
1100	0.936	-46.6	3.07	143.2	0.0707	58.2	0.913	-24.3
1200	0.927	-50.9	3.06	139.6	0.0758	55.6	0.898	-26.4
1300	0.918	-55.0	3.01	136.6	0.0812	53.4	0.885	-28.3
1400	0.912	-59.1	2.97	133.7	0.0866	50.8	0.873	-30.2
1500	0.902	-63.3	2.95	130.7	0.0905	48.3	0.859	-32.2
1600	0.892	-67.5	2.93	127.6	0.0950	45.7	0.845	-33.9
1700	0.884	-71.5	2.89	124.7	0.0990	42.7	0.831	-35.8
1800	0.875	-75.5	2.84	121.7	0.1030	40.7	0.817	-37.5
1900	0.866	-79.5	2.80	118.9	0.1060	38.3	0.803	-39.3
2000	0.858	-83.7	2.76	116.2	0.1089	35.6	0.789	-41.1
2200	0.842	-91.3	2.67	110.6	0.1148	31.4	0.763	-44.5
2400	0.828	-99.0	2.59	105.2	0.1191	27.1	0.736	-47.9
2600	0.813	-106.4	2.50	100.1	0.1233	22.8	0.709	-51.0
2800	0.802	-113.6	2.42	95.1	0.1258	18.9	0.686	-54.2
3000	0.788	-120.5	2.34	90.1	0.1277	15.2	0.663	-57.2
3200	0.779	-127.0	2.25	85.5	0.1284	11.6	0.643	-60.4
3400	0.770	-133.3	2.16	80.9	0.1292	8.2	0.623	-63.4
3600	0.762	-139.2	2.08	76.6	0.1284	4.7	0.604	-66.3
3800	0.757	-144.8	2.00	72.5	0.1267	2.2	0.588	-69.3
4000	0.754	-150.3	1.93	68.4	0.1264	-0.3	0.574	-72.2
4200	0.750	-155.5	1.87	64.5	0.1251	-2.7	0.561	-75.2
4400	0.748	-160.4	1.80	60.6	0.1232	-5.4	0.549	-78.1
4600	0.746	-165.1	1.74	56.9	0.1209	-7.7	0.538	-81.1
4800	0.745	-169.6	1.68	53.3	0.1196	-9.7	0.529	-84.0
5000	0.744	-173.9	1.62	49.7	0.1169	-11.7	0.520	-87.1
5200	0.743	-178.1	1.57	46.3	0.1143	-13.6	0.511	-90.0
5400	0.744	178.1	1.51	43.0	0.1119	-15.0	0.505	-93.1
5600	0.744	174.4	1.47	39.7	0.1093	-16.6	0.498	-96.1
5800	0.744	170.7	1.42	36.4	0.1067	-18.1	0.493	-99.2
6000	0.744	167.2	1.38	33.3	0.1031	-19.0	0.487	-102.3

S Parameter

 $(V_{CE} = 2 \text{ V}, I_C = 3 \text{ mA}, Z_O = 50 \Omega)$

f (MHz)	S11		S21		S12		S22	
	MAG	ANG	MAG	ANG	MAG	ANG	MAG	ANG
100	0.950	-6.1	9.18	174.7	0.0151	97.3	0.975	-4.2
200	0.949	-12.5	9.14	169.5	0.0138	90.5	0.991	-7.6
300	0.940	-18.2	9.05	164.7	0.0207	81.6	0.978	-11.2
400	0.930	-24.7	8.96	160.1	0.0268	76.8	0.963	-14.7
500	0.920	-30.8	8.86	155.7	0.0333	70.7	0.948	-18.3
600	0.908	-36.9	8.73	151.5	0.0391	67.3	0.929	-21.5
700	0.895	-42.5	8.50	147.3	0.0442	62.5	0.907	-24.8
800	0.879	-48.3	8.32	143.3	0.0493	59.7	0.883	-28.0
900	0.867	-54.4	8.26	139.9	0.0531	56.9	0.858	-30.8
1000	0.850	-59.9	8.05	135.7	0.0581	53.2	0.833	-33.6
1100	0.833	-65.3	7.85	132.0	0.0618	51.1	0.809	-36.3
1200	0.815	-71.0	7.71	128.0	0.0656	47.1	0.783	-38.8
1300	0.799	-76.1	7.47	124.6	0.0676	44.7	0.758	-41.3
1400	0.785	-81.1	7.25	121.4	0.0714	43.1	0.734	-43.6
1500	0.770	-86.3	7.07	118.1	0.0740	39.8	0.710	-45.9
1600	0.755	-91.3	6.89	114.9	0.0759	38.5	0.687	-47.9
1700	0.742	-96.0	6.69	111.8	0.0787	36.1	0.665	-50.0
1800	0.730	-100.5	6.48	108.9	0.0800	34.1	0.643	-52.0
1900	0.718	-105.0	6.30	106.1	0.0817	32.3	0.622	-53.9
2000	0.708	-109.6	6.11	103.4	0.0832	30.2	0.601	-55.7
2200	0.690	-117.6	5.75	98.2	0.0848	27.1	0.566	-59.3
2400	0.675	-125.5	5.43	93.2	0.0863	24.2	0.531	-62.5
2600	0.663	-132.8	5.12	88.7	0.0879	20.9	0.499	-65.9
2800	0.653	-139.6	4.84	84.3	0.0884	19.4	0.472	-68.8
3000	0.645	-146.1	4.58	80.1	0.0897	17.0	0.448	-71.7
3200	0.640	-152.0	4.33	76.2	0.0885	14.9	0.425	-74.8
3400	0.635	-157.6	4.11	72.4	0.0888	13.1	0.406	-77.7
3600	0.632	-162.9	3.90	68.8	0.0888	11.5	0.387	-80.5
3800	0.630	-167.5	3.72	65.5	0.0873	10.3	0.372	-83.5
4000	0.631	-172.0	3.55	62.1	0.0886	9.6	0.359	-86.6
4200	0.632	-176.4	3.39	58.8	0.0877	8.9	0.347	-89.5
4400	0.633	179.6	3.25	55.6	0.0880	8.0	0.337	-92.5
4600	0.634	175.8	3.11	52.6	0.0866	6.9	0.328	-95.6
4800	0.635	172.2	2.98	49.6	0.0866	6.6	0.319	-98.8
5000	0.638	168.7	2.87	46.6	0.0868	6.3	0.312	-101.7
5200	0.641	165.3	2.76	43.7	0.0863	5.8	0.305	-104.9
5400	0.643	162.2	2.66	40.9	0.0865	5.2	0.300	-108.1
5600	0.645	159.2	2.56	38.1	0.0866	5.0	0.294	-111.3
5800	0.647	156.2	2.47	35.3	0.0862	4.5	0.290	-114.4
6000	0.649	153.3	2.39	32.6	0.0859	4.5	0.286	-117.7

S Parameter

 $(V_{CE} = 2 \text{ V}, I_C = 5 \text{ mA}, Z_O = 50 \Omega)$

f (MHz)	S11		S21		S12		S22	
	MAG	ANG	MAG	ANG	MAG	ANG	MAG	ANG
100	0.933	-8.1	14.69	173.2	0.0057	127.0	0.977	-5.6
200	0.920	-15.9	14.57	167.0	0.0148	82.2	0.984	-10.0
300	0.903	-23.4	14.31	161.1	0.0221	76.2	0.964	-14.7
400	0.890	-31.4	14.02	155.6	0.0247	73.7	0.938	-19.2
500	0.870	-39.0	13.70	150.4	0.0311	68.3	0.914	-23.7
600	0.850	-46.5	13.35	145.4	0.0358	63.3	0.883	-27.7
700	0.830	-53.3	12.85	140.7	0.0409	59.3	0.850	-31.8
800	0.809	-60.2	12.44	136.1	0.0445	54.8	0.815	-35.4
900	0.789	-67.3	12.13	132.0	0.0471	52.3	0.780	-38.6
1000	0.767	-73.7	11.68	127.7	0.0511	48.5	0.747	-41.8
1100	0.747	-79.8	11.23	123.7	0.0537	46.2	0.715	-44.7
1200	0.725	-86.1	10.85	119.7	0.0565	43.8	0.684	-47.4
1300	0.707	-91.6	10.40	116.2	0.0581	41.3	0.653	-49.9
1400	0.691	-97.0	9.97	113.0	0.0609	40.0	0.625	-52.3
1500	0.676	-102.4	9.60	109.8	0.0614	38.0	0.598	-54.6
1600	0.662	-107.6	9.23	106.7	0.0639	36.0	0.572	-56.6
1700	0.650	-112.3	8.87	103.8	0.0657	34.0	0.548	-58.7
1800	0.639	-116.9	8.52	101.1	0.0667	33.2	0.525	-60.6
1900	0.628	-121.5	8.20	98.4	0.0666	31.3	0.504	-62.5
2000	0.621	-125.8	7.89	95.9	0.0682	30.4	0.484	-64.3
2200	0.607	-133.5	7.32	91.2	0.0693	28.2	0.449	-67.7
2400	0.597	-141.0	6.83	86.7	0.0701	26.7	0.415	-70.9
2600	0.590	-147.8	6.38	82.6	0.0716	24.4	0.387	-74.2
2800	0.585	-154.0	5.98	78.8	0.0721	23.4	0.362	-77.2
3000	0.581	-159.7	5.61	75.1	0.0725	22.0	0.339	-80.4
3200	0.581	-165.1	5.29	71.5	0.0743	21.7	0.320	-83.6
3400	0.580	-170.0	4.99	68.2	0.0744	20.1	0.303	-86.9
3600	0.579	-174.6	4.72	65.0	0.0752	20.0	0.286	-90.0
3800	0.580	-178.6	4.48	62.0	0.0749	19.2	0.275	-93.0
4000	0.583	177.4	4.26	59.0	0.0763	19.3	0.264	-96.5
4200	0.587	173.7	4.06	56.0	0.0770	18.7	0.255	-99.9
4400	0.589	170.1	3.88	53.1	0.0782	18.8	0.246	-103.4
4600	0.593	166.9	3.71	50.4	0.0791	18.6	0.239	-106.8
4800	0.595	163.6	3.56	47.7	0.0804	17.8	0.232	-110.2
5000	0.598	160.6	3.41	45.0	0.0804	17.6	0.227	-113.7
5200	0.603	157.6	3.28	42.3	0.0814	17.2	0.221	-117.6
5400	0.606	154.9	3.16	39.7	0.0827	16.8	0.219	-121.0
5600	0.609	152.2	3.04	37.1	0.0838	17.0	0.215	-124.7
5800	0.611	149.5	2.93	34.5	0.0855	16.1	0.212	-128.3
6000	0.615	146.9	2.83	32.0	0.0863	16.4	0.210	-132.1

S Parameter

 $(V_{CE} = 2 \text{ V}, I_C = 7 \text{ mA}, Z_0 = 50 \Omega)$

f (MHz)	S11		S21		S12		S22	
	MAG	ANG	MAG	ANG	MAG	ANG	MAG	ANG
100	0.905	-9.6	19.82	172.0	0.0091	100.4	0.962	-7.2
200	0.893	-19.2	19.52	164.8	0.0131	83.9	0.975	-12.2
300	0.868	-28.3	19.02	158.0	0.0184	70.1	0.947	-17.9
400	0.848	-37.4	18.44	151.7	0.0232	69.6	0.913	-23.2
500	0.822	-46.3	17.84	145.9	0.0295	63.5	0.877	-28.4
600	0.797	-54.9	17.17	140.3	0.0337	58.9	0.836	-32.9
700	0.772	-62.6	16.35	135.2	0.0379	55.5	0.794	-37.3
800	0.747	-70.3	15.65	130.3	0.0414	52.0	0.752	-41.2
900	0.724	-78.1	15.03	125.9	0.0436	49.2	0.712	-44.6
1000	0.700	-84.9	14.31	121.5	0.0463	46.2	0.673	-47.8
1100	0.679	-91.4	13.59	117.6	0.0477	44.6	0.638	-50.7
1200	0.657	-97.9	12.98	113.7	0.0495	42.6	0.604	-53.4
1300	0.639	-103.7	12.33	110.3	0.0520	40.1	0.573	-55.9
1400	0.626	-109.0	11.73	107.2	0.0530	39.1	0.544	-58.3
1500	0.612	-114.4	11.19	104.2	0.0549	37.4	0.516	-60.6
1600	0.600	-119.4	10.68	101.3	0.0557	36.5	0.491	-62.4
1700	0.590	-124.1	10.20	98.6	0.0568	35.4	0.468	-64.5
1800	0.582	-128.6	9.75	96.0	0.0576	34.1	0.446	-66.3
1900	0.574	-132.8	9.33	93.6	0.0582	33.3	0.426	-68.3
2000	0.568	-137.0	8.94	91.3	0.0591	31.7	0.407	-69.9
2200	0.559	-144.2	8.24	86.9	0.0609	30.5	0.374	-73.4
2400	0.554	-151.2	7.63	82.9	0.0617	29.9	0.344	-76.7
2600	0.550	-157.4	7.10	79.1	0.0630	29.1	0.318	-80.2
2800	0.549	-163.1	6.63	75.6	0.0636	28.6	0.296	-83.4
3000	0.549	-168.3	6.20	72.1	0.0654	27.4	0.277	-86.5
3200	0.550	-173.1	5.82	68.9	0.0675	27.3	0.260	-90.4
3400	0.551	-177.6	5.49	65.8	0.0671	26.9	0.245	-93.9
3600	0.552	178.2	5.18	62.8	0.0684	26.2	0.231	-97.4
3800	0.555	174.6	4.91	60.0	0.0700	26.8	0.220	-100.9
4000	0.559	171.1	4.66	57.2	0.0719	26.4	0.212	-104.9
4200	0.563	167.7	4.44	54.5	0.0736	26.1	0.205	-108.8
4400	0.568	164.5	4.24	51.8	0.0745	25.6	0.199	-112.8
4600	0.572	161.6	4.05	49.2	0.0763	25.0	0.192	-116.7
4800	0.575	158.7	3.88	46.6	0.0782	24.9	0.188	-120.7
5000	0.580	155.9	3.72	44.0	0.0789	24.4	0.184	-124.7
5200	0.584	153.1	3.58	41.5	0.0808	24.1	0.181	-128.9
5400	0.587	150.6	3.44	39.0	0.0834	23.7	0.178	-133.1
5600	0.591	148.1	3.31	36.6	0.0844	23.3	0.177	-136.7
5800	0.594	145.6	3.20	34.1	0.0862	22.6	0.176	-140.8
6000	0.597	143.3	3.09	31.7	0.0886	22.5	0.175	-144.9

S Parameter

 $(V_{CE} = 2 \text{ V}, I_C = 10 \text{ mA}, Z_O = 50 \Omega)$

f (MHz)	S11		S21		S12		S22	
	MAG	ANG	MAG	ANG	MAG	ANG	MAG	ANG
100	0.869	-11.9	26.85	170.5	0.0102	80.4	0.950	-8.4
200	0.849	-23.7	26.20	161.9	0.0141	72.6	0.960	-15.1
300	0.822	-34.8	25.19	153.9	0.0185	66.0	0.918	-22.0
400	0.792	-45.7	24.09	146.8	0.0242	66.8	0.874	-28.3
500	0.759	-56.1	22.92	140.2	0.0282	60.1	0.822	-34.1
600	0.728	-65.9	21.68	134.2	0.0305	54.9	0.772	-39.1
700	0.700	-74.6	20.34	128.8	0.0340	52.8	0.721	-43.7
800	0.672	-83.0	19.15	123.6	0.0363	49.6	0.672	-47.7
900	0.647	-91.3	18.06	119.2	0.0379	46.5	0.627	-51.1
1000	0.623	-98.3	16.96	114.9	0.0407	45.0	0.588	-54.2
1100	0.605	-104.9	15.93	111.2	0.0415	43.6	0.550	-57.1
1200	0.587	-111.3	15.02	107.6	0.0430	43.1	0.516	-59.6
1300	0.573	-116.9	14.14	104.4	0.0446	41.0	0.485	-61.9
1400	0.562	-122.2	13.35	101.4	0.0455	40.0	0.458	-64.3
1500	0.552	-127.4	12.65	98.7	0.0471	39.6	0.432	-66.4
1600	0.543	-132.1	11.99	96.1	0.0478	38.4	0.408	-68.2
1700	0.535	-136.5	11.39	93.6	0.0492	37.6	0.387	-70.2
1800	0.531	-140.7	10.84	91.3	0.0491	37.2	0.368	-72.0
1900	0.528	-144.6	10.33	89.1	0.0502	35.8	0.349	-73.8
2000	0.523	-148.3	9.87	87.0	0.0515	36.0	0.333	-75.7
2200	0.519	-155.0	9.04	83.1	0.0532	35.4	0.304	-79.1
2400	0.518	-161.2	8.34	79.3	0.0551	35.5	0.279	-82.8
2600	0.519	-166.7	7.72	75.9	0.0568	34.5	0.256	-86.7
2800	0.520	-171.7	7.19	72.7	0.0581	33.6	0.237	-90.1
3000	0.522	-176.5	6.71	69.5	0.0603	34.0	0.221	-94.0
3200	0.526	179.3	6.30	66.5	0.0618	33.5	0.207	-98.3
3400	0.529	175.3	5.92	63.6	0.0633	34.2	0.195	-102.4
3600	0.532	171.6	5.58	60.9	0.0648	33.2	0.183	-106.8
3800	0.535	168.3	5.28	58.3	0.0667	34.0	0.175	-110.7
4000	0.540	165.2	5.02	55.7	0.0699	33.5	0.170	-115.4
4200	0.545	162.2	4.78	53.1	0.0715	32.7	0.164	-120.1
4400	0.550	159.4	4.56	50.5	0.0734	32.6	0.162	-124.7
4600	0.556	156.7	4.35	48.1	0.0754	31.7	0.158	-129.3
4800	0.558	154.1	4.17	45.7	0.0780	31.2	0.155	-133.6
5000	0.563	151.5	4.00	43.2	0.0795	30.8	0.154	-138.4
5200	0.568	149.1	3.84	40.8	0.0823	30.7	0.153	-142.9
5400	0.572	146.7	3.69	38.4	0.0848	29.2	0.153	-147.3
5600	0.576	144.4	3.56	36.1	0.0861	28.3	0.152	-151.6
5800	0.580	142.1	3.43	33.7	0.0888	28.1	0.153	-155.8
6000	0.583	139.9	3.31	31.4	0.0905	27.3	0.154	-160.0

S Parameter

 $(V_{CE} = 2 \text{ V}, I_C = 20 \text{ mA}, Z_O = 50 \Omega)$

f (MHz)	S11		S21		S12		S22	
	MAG	ANG	MAG	ANG	MAG	ANG	MAG	ANG
100	0.768	-18.6	45.55	166.4	0.0041	105.6	0.926	-12.8
200	0.735	-36.6	43.17	154.5	0.0113	71.2	0.911	-22.4
300	0.689	-52.9	39.88	144.1	0.0145	65.3	0.836	-31.5
400	0.650	-67.6	36.45	135.3	0.0195	66.0	0.755	-39.1
500	0.610	-80.7	33.08	127.7	0.0226	54.9	0.683	-45.7
600	0.578	-92.1	29.94	121.3	0.0238	51.4	0.615	-50.8
700	0.553	-101.8	27.13	116.0	0.0272	49.9	0.555	-55.1
800	0.532	-110.6	24.71	111.3	0.0281	48.0	0.506	-58.7
900	0.517	-118.4	22.61	107.3	0.0292	45.7	0.462	-62.0
1000	0.503	-125.1	20.78	103.8	0.0307	47.5	0.425	-64.5
1100	0.493	-131.1	19.19	100.6	0.0313	47.0	0.393	-66.9
1200	0.486	-136.9	17.81	97.7	0.0323	45.1	0.364	-69.2
1300	0.480	-141.6	16.58	95.1	0.0340	46.3	0.339	-71.5
1400	0.476	-146.1	15.51	92.7	0.0353	47.3	0.317	-73.5
1500	0.474	-150.4	14.56	90.4	0.0367	46.0	0.297	-75.3
1600	0.472	-154.1	13.70	88.3	0.0373	47.1	0.280	-77.1
1700	0.470	-157.7	12.94	86.3	0.0390	46.2	0.262	-79.2
1800	0.471	-161.0	12.26	84.4	0.0399	45.7	0.248	-81.1
1900	0.471	-164.1	11.63	82.5	0.0410	46.4	0.235	-83.1
2000	0.472	-166.9	11.07	80.8	0.0426	46.4	0.222	-85.0
2200	0.474	-172.2	10.08	77.5	0.0449	47.0	0.201	-89.3
2400	0.478	-176.9	9.25	74.4	0.0475	46.8	0.184	-93.9
2600	0.482	178.8	8.54	71.4	0.0498	46.4	0.170	-98.5
2800	0.488	174.8	7.93	68.6	0.0526	45.7	0.157	-103.9
3000	0.493	171.2	7.39	65.9	0.0554	46.2	0.146	-108.8
3200	0.498	167.9	6.92	63.2	0.0584	45.3	0.138	-115.5
3400	0.504	164.6	6.50	60.6	0.0605	44.6	0.132	-121.3
3600	0.508	161.6	6.12	58.2	0.0631	45.2	0.125	-127.0
3800	0.513	159.1	5.79	55.9	0.0661	44.1	0.123	-132.4
4000	0.519	156.6	5.50	53.5	0.0685	43.7	0.122	-138.1
4200	0.525	154.2	5.22	51.2	0.0714	42.6	0.122	-144.3
4400	0.530	151.8	4.98	48.8	0.0744	41.6	0.124	-149.7
4600	0.536	149.6	4.76	46.6	0.0764	40.8	0.125	-154.5
4800	0.541	147.4	4.55	44.3	0.0792	39.9	0.126	-159.7
5000	0.546	145.2	4.36	42.0	0.0825	39.3	0.128	-164.4
5200	0.551	143.0	4.19	39.8	0.0853	38.4	0.131	-169.1
5400	0.555	141.0	4.03	37.6	0.0878	37.0	0.135	-173.6
5600	0.560	139.0	3.88	35.4	0.0907	36.0	0.138	-177.1
5800	0.564	137.0	3.74	33.2	0.0926	34.8	0.141	178.9
6000	0.567	135.0	3.61	30.9	0.0956	33.7	0.144	175.2

S Parameter

 $(V_{CE} = 2 \text{ V}, I_C = 30 \text{ mA}, Z_O = 50 \Omega)$

f (MHz)	S11		S21		S12		S22	
	MAG	ANG	MAG	ANG	MAG	ANG	MAG	ANG
100	0.674	-24.0	57.42	163.6	0.0107	49.1	0.869	-13.2
200	0.634	-47.8	53.46	149.4	0.0099	78.2	0.863	-27.1
300	0.592	-67.1	47.90	137.6	0.0137	59.5	0.763	-37.3
400	0.558	-83.9	42.40	128.3	0.0178	56.0	0.669	-45.4
500	0.528	-97.6	37.38	120.8	0.0181	54.4	0.591	-51.4
600	0.504	-109.2	33.08	114.8	0.0207	52.0	0.522	-56.1
700	0.488	-118.5	29.49	109.9	0.0228	50.5	0.466	-59.9
800	0.477	-126.6	26.51	105.7	0.0238	48.9	0.421	-63.2
900	0.468	-133.6	24.01	102.1	0.0247	49.4	0.381	-66.0
1000	0.463	-139.8	21.92	99.0	0.0261	50.1	0.349	-68.4
1100	0.459	-145.0	20.13	96.1	0.0283	50.7	0.320	-70.7
1200	0.456	-149.8	18.59	93.6	0.0287	50.3	0.297	-72.5
1300	0.453	-153.9	17.24	91.3	0.0293	50.8	0.274	-74.6
1400	0.453	-157.8	16.09	89.1	0.0323	51.2	0.256	-76.4
1500	0.453	-161.4	15.07	87.1	0.0329	50.6	0.239	-78.5
1600	0.454	-164.5	14.15	85.2	0.0349	52.8	0.224	-80.3
1700	0.455	-167.5	13.34	83.4	0.0357	51.7	0.211	-82.3
1800	0.456	-170.3	12.62	81.7	0.0376	52.7	0.199	-84.4
1900	0.458	-172.9	11.97	80.0	0.0381	52.7	0.188	-86.9
2000	0.461	-175.3	11.37	78.4	0.0397	53.2	0.179	-89.0
2200	0.465	-179.8	10.34	75.3	0.0426	52.2	0.162	-93.7
2400	0.471	176.2	9.48	72.4	0.0457	51.9	0.147	-98.7
2600	0.477	172.5	8.74	69.7	0.0482	51.3	0.136	-104.9
2800	0.482	169.0	8.11	67.0	0.0513	51.7	0.126	-110.5
3000	0.488	166.0	7.55	64.5	0.0545	50.5	0.119	-117.6
3200	0.495	163.0	7.07	61.9	0.0573	50.1	0.114	-124.3
3400	0.501	160.1	6.64	59.5	0.0600	49.8	0.111	-131.0
3600	0.505	157.4	6.25	57.1	0.0625	49.4	0.108	-137.8
3800	0.511	155.3	5.91	54.9	0.0659	48.9	0.107	-143.7
4000	0.517	153.0	5.61	52.6	0.0691	47.4	0.109	-149.8
4200	0.523	150.7	5.33	50.3	0.0726	46.2	0.112	-155.9
4400	0.529	148.5	5.09	48.1	0.0751	45.4	0.115	-161.5
4600	0.535	146.5	4.86	45.9	0.0784	44.2	0.117	-166.0
4800	0.540	144.4	4.65	43.7	0.0808	43.1	0.121	-170.6
5000	0.545	142.4	4.45	41.5	0.0839	42.2	0.124	-175.0
5200	0.550	140.4	4.28	39.3	0.0863	40.3	0.129	-179.5
5400	0.554	138.6	4.11	37.1	0.0896	39.8	0.134	176.9
5600	0.558	136.7	3.96	35.0	0.0922	39.0	0.138	173.4
5800	0.562	134.8	3.82	32.8	0.0953	37.0	0.143	169.7
6000	0.566	132.8	3.69	30.7	0.0977	35.9	0.146	166.3

S Parameter

 $(V_{CE} = 3 \text{ V}, I_C = 1 \text{ mA}, Z_O = 50 \Omega)$

f (MHz)	S11		S21		S12		S22	
	MAG	ANG	MAG	ANG	MAG	ANG	MAG	ANG
100	0.983	-4.3	3.17	176.3	0.0057	109.1	0.995	-2.7
200	0.982	-8.7	3.18	172.4	0.0126	83.1	0.995	-4.6
300	0.978	-12.6	3.17	168.7	0.0207	80.9	0.991	-6.8
400	0.976	-17.2	3.17	165.6	0.0263	81.2	0.984	-9.0
500	0.972	-21.5	3.17	162.2	0.0333	75.6	0.979	-11.3
600	0.967	-25.7	3.16	159.1	0.0384	72.6	0.970	-13.3
700	0.962	-30.0	3.11	155.8	0.0446	70.1	0.961	-15.5
800	0.956	-34.2	3.09	152.5	0.0508	66.6	0.950	-17.6
900	0.952	-38.5	3.11	150.1	0.0564	65.0	0.940	-19.6
1000	0.944	-42.9	3.09	146.3	0.0617	61.2	0.927	-21.6
1100	0.937	-47.0	3.06	143.3	0.0673	57.9	0.917	-23.6
1200	0.928	-51.3	3.05	139.6	0.0716	56.0	0.904	-25.5
1300	0.919	-55.3	3.00	136.6	0.0768	53.6	0.891	-27.4
1400	0.913	-59.5	2.96	133.7	0.0816	50.7	0.879	-29.2
1500	0.903	-63.7	2.94	130.7	0.0856	47.8	0.866	-31.1
1600	0.894	-67.9	2.92	127.7	0.0891	45.6	0.852	-32.8
1700	0.886	-71.9	2.88	124.8	0.0937	43.3	0.839	-34.7
1800	0.878	-75.9	2.83	121.8	0.0978	40.9	0.825	-36.3
1900	0.869	-79.8	2.79	119.0	0.1007	38.3	0.812	-38.1
2000	0.861	-83.9	2.76	116.3	0.1035	36.4	0.799	-39.9
2200	0.846	-91.5	2.67	110.7	0.1094	31.3	0.773	-43.2
2400	0.831	-99.0	2.59	105.4	0.1128	27.6	0.747	-46.4
2600	0.817	-106.4	2.51	100.3	0.1162	23.3	0.721	-49.5
2800	0.804	-113.4	2.42	95.3	0.1186	19.6	0.698	-52.6
3000	0.792	-120.3	2.34	90.3	0.1210	15.8	0.677	-55.5
3200	0.783	-126.7	2.25	85.7	0.1213	12.4	0.657	-58.6
3400	0.773	-132.9	2.18	81.2	0.1224	8.9	0.638	-61.6
3600	0.765	-138.9	2.10	76.9	0.1220	5.8	0.620	-64.5
3800	0.759	-144.3	2.02	72.8	0.1206	2.6	0.605	-67.5
4000	0.755	-149.8	1.95	68.7	0.1204	0.2	0.590	-70.4
4200	0.751	-155.0	1.89	64.8	0.1187	-2.6	0.577	-73.3
4400	0.748	-159.9	1.82	60.9	0.1170	-4.8	0.565	-76.3
4600	0.745	-164.6	1.76	57.1	0.1160	-7.1	0.555	-79.2
4800	0.742	-169.1	1.70	53.5	0.1134	-8.9	0.545	-82.2
5000	0.741	-173.4	1.65	49.9	0.1113	-11.1	0.535	-85.1
5200	0.739	-177.8	1.60	46.4	0.1090	-12.9	0.527	-88.1
5400	0.739	178.3	1.54	43.0	0.1072	-14.6	0.521	-91.1
5600	0.738	174.4	1.50	39.7	0.1044	-15.7	0.514	-94.1
5800	0.737	170.6	1.45	36.3	0.1016	-17.4	0.508	-97.2
6000	0.736	166.9	1.41	33.1	0.1000	-18.3	0.503	-100.1

S Parameter

 $(V_{CE} = 3 \text{ V}, I_C = 3 \text{ mA}, Z_O = 50 \Omega)$

f (MHz)	S11		S21		S12		S22	
	MAG	ANG	MAG	ANG	MAG	ANG	MAG	ANG
100	0.960	-6.0	9.09	174.7	0.0049	83.6	0.983	-4.0
200	0.951	-12.3	9.07	169.7	0.0133	80.1	0.989	-7.2
300	0.942	-18.0	8.98	164.9	0.0188	78.0	0.978	-10.6
400	0.933	-24.4	8.91	160.4	0.0258	74.3	0.966	-14.0
500	0.921	-30.4	8.82	156.1	0.0309	69.5	0.950	-17.4
600	0.909	-36.3	8.69	152.0	0.0352	67.8	0.933	-20.5
700	0.898	-42.0	8.47	147.8	0.0424	62.8	0.912	-23.7
800	0.882	-47.6	8.30	143.8	0.0469	59.9	0.889	-26.7
900	0.870	-53.6	8.24	140.4	0.0506	56.4	0.866	-29.5
1000	0.853	-59.2	8.05	136.2	0.0553	54.1	0.841	-32.1
1100	0.837	-64.5	7.85	132.5	0.0591	50.9	0.818	-34.6
1200	0.819	-70.2	7.72	128.6	0.0619	47.9	0.793	-37.2
1300	0.803	-75.2	7.49	125.2	0.0658	45.5	0.769	-39.6
1400	0.789	-80.2	7.27	121.9	0.0687	44.0	0.747	-41.8
1500	0.774	-85.3	7.10	118.7	0.0712	40.8	0.722	-44.0
1600	0.758	-90.3	6.92	115.5	0.0732	38.8	0.700	-45.9
1700	0.746	-94.9	6.72	112.4	0.0756	36.4	0.678	-47.9
1800	0.733	-99.6	6.51	109.5	0.0764	34.1	0.656	-49.7
1900	0.721	-104.0	6.33	106.6	0.0781	33.1	0.636	-51.6
2000	0.711	-108.5	6.15	103.9	0.0789	31.0	0.617	-53.4
2200	0.692	-116.5	5.79	98.7	0.0818	27.8	0.580	-56.7
2400	0.676	-124.4	5.47	93.8	0.0830	25.1	0.547	-59.9
2600	0.664	-131.8	5.17	89.2	0.0845	21.7	0.516	-63.0
2800	0.654	-138.6	4.89	84.8	0.0845	20.5	0.488	-65.8
3000	0.645	-145.0	4.63	80.6	0.0859	17.6	0.465	-68.6
3200	0.640	-151.0	4.38	76.7	0.0856	16.0	0.442	-71.5
3400	0.635	-156.6	4.16	72.9	0.0856	13.6	0.423	-74.2
3600	0.631	-161.8	3.95	69.3	0.0848	12.6	0.404	-77.0
3800	0.629	-166.6	3.76	65.9	0.0837	11.0	0.390	-79.8
4000	0.628	-171.1	3.59	62.5	0.0840	10.3	0.376	-82.4
4200	0.629	-175.5	3.44	59.2	0.0838	9.7	0.364	-85.5
4400	0.630	-179.6	3.29	56.0	0.0841	8.9	0.353	-88.4
4600	0.632	-176.6	3.16	53.0	0.0836	8.4	0.344	-91.3
4800	0.632	-172.9	3.03	50.0	0.0834	7.4	0.335	-94.2
5000	0.635	-169.4	2.91	47.0	0.0829	7.0	0.328	-97.1
5200	0.637	-165.9	2.80	44.0	0.0831	6.8	0.320	-100.2
5400	0.639	-162.8	2.70	41.2	0.0828	6.6	0.315	-103.3
5600	0.641	-159.7	2.60	38.4	0.0830	6.2	0.309	-106.3
5800	0.643	-156.6	2.51	35.6	0.0827	6.1	0.305	-109.5
6000	0.644	-153.6	2.43	32.9	0.0833	5.6	0.300	-112.7

S Parameter

 $(V_{CE} = 3 \text{ V}, I_C = 5 \text{ mA}, Z_O = 50 \Omega)$

f (MHz)	S11		S21		S12		S22	
	MAG	ANG	MAG	ANG	MAG	ANG	MAG	ANG
100	0.932	-7.6	14.55	173.4	0.0077	30.4	0.978	-4.9
200	0.921	-15.6	14.43	167.2	0.0127	85.0	0.982	-9.6
300	0.904	-23.0	14.19	161.5	0.0177	81.7	0.966	-13.8
400	0.891	-30.8	13.93	156.0	0.0264	72.1	0.941	-18.4
500	0.872	-38.3	13.65	150.9	0.0296	69.7	0.917	-22.6
600	0.853	-45.6	13.31	146.0	0.0345	62.9	0.887	-26.4
700	0.833	-52.3	12.82	141.3	0.0393	60.3	0.855	-30.3
800	0.811	-59.2	12.44	136.7	0.0431	55.4	0.823	-33.7
900	0.792	-66.2	12.15	132.7	0.0460	52.7	0.789	-36.8
1000	0.771	-72.5	11.71	128.3	0.0497	50.0	0.757	-39.8
1100	0.750	-78.6	11.27	124.4	0.0517	46.9	0.726	-42.5
1200	0.728	-84.9	10.91	120.4	0.0536	44.9	0.694	-45.2
1300	0.710	-90.4	10.47	116.9	0.0562	42.8	0.665	-47.6
1400	0.694	-95.8	10.04	113.6	0.0579	40.8	0.638	-49.9
1500	0.678	-101.2	9.68	110.4	0.0600	39.5	0.610	-52.1
1600	0.663	-106.3	9.31	107.3	0.0611	36.8	0.586	-53.9
1700	0.651	-111.1	8.96	104.4	0.0624	34.7	0.562	-55.9
1800	0.640	-115.8	8.61	101.6	0.0642	33.4	0.540	-57.7
1900	0.629	-120.2	8.29	99.0	0.0648	32.2	0.519	-59.4
2000	0.621	-124.6	7.98	96.5	0.0661	30.9	0.500	-61.2
2200	0.607	-132.3	7.41	91.7	0.0669	28.6	0.463	-64.4
2400	0.596	-139.8	6.92	87.2	0.0683	27.5	0.431	-67.3
2600	0.588	-146.7	6.47	83.1	0.0691	25.6	0.402	-70.3
2800	0.583	-152.9	6.06	79.3	0.0697	23.5	0.377	-73.3
3000	0.579	-158.7	5.69	75.5	0.0705	23.4	0.355	-75.9
3200	0.578	-164.0	5.36	72.0	0.0707	22.3	0.336	-79.1
3400	0.577	-169.1	5.07	68.6	0.0715	21.0	0.318	-81.9
3600	0.576	-173.7	4.79	65.4	0.0725	21.0	0.302	-84.8
3800	0.576	-177.8	4.55	62.4	0.0726	20.3	0.289	-87.7
4000	0.579	178.2	4.33	59.4	0.0736	20.1	0.278	-90.8
4200	0.582	174.4	4.13	56.4	0.0743	19.7	0.268	-93.8
4400	0.585	170.9	3.94	53.5	0.0741	19.8	0.260	-97.1
4600	0.588	167.5	3.78	50.8	0.0757	19.2	0.252	-100.4
4800	0.591	164.3	3.62	48.0	0.0762	18.6	0.245	-103.7
5000	0.594	161.3	3.47	45.3	0.0778	19.0	0.240	-106.8
5200	0.598	158.2	3.34	42.6	0.0795	18.1	0.234	-110.5
5400	0.601	155.5	3.21	40.0	0.0802	17.7	0.229	-113.9
5600	0.604	152.7	3.10	37.4	0.0811	18.3	0.226	-117.2
5800	0.607	150.1	2.99	34.8	0.0820	17.6	0.222	-120.8
6000	0.610	147.4	2.89	32.3	0.0838	17.5	0.219	-124.4

S Parameter

 $(V_{CE} = 3 \text{ V}, I_C = 7 \text{ mA}, Z_O = 50 \Omega)$

f (MHz)	S11		S21		S12		S22	
	MAG	ANG	MAG	ANG	MAG	ANG	MAG	ANG
100	0.901	-9.3	19.67	172.2	0.0079	72.7	0.964	-6.0
200	0.894	-18.8	19.38	165.1	0.0129	76.9	0.973	-11.6
300	0.870	-27.6	18.91	158.4	0.0169	74.6	0.949	-17.1
400	0.849	-36.6	18.38	152.2	0.0218	70.8	0.915	-22.1
500	0.825	-45.3	17.81	146.5	0.0279	61.0	0.880	-27.0
600	0.800	-53.8	17.16	141.0	0.0315	58.9	0.842	-31.3
700	0.775	-61.4	16.37	135.9	0.0364	54.8	0.801	-35.5
800	0.750	-69.0	15.69	131.0	0.0387	51.5	0.761	-39.2
900	0.726	-76.7	15.10	126.6	0.0419	48.9	0.722	-42.4
1000	0.701	-83.4	14.39	122.3	0.0449	47.8	0.684	-45.4
1100	0.680	-89.9	13.69	118.3	0.0464	45.3	0.650	-48.2
1200	0.659	-96.5	13.09	114.4	0.0485	42.6	0.617	-50.8
1300	0.641	-102.1	12.44	111.0	0.0492	40.6	0.585	-53.1
1400	0.627	-107.6	11.84	107.9	0.0508	39.9	0.558	-55.3
1500	0.612	-113.0	11.31	104.8	0.0524	38.6	0.530	-57.3
1600	0.600	-118.0	10.80	101.9	0.0528	36.9	0.505	-59.1
1700	0.590	-122.7	10.32	99.2	0.0542	35.6	0.482	-61.1
1800	0.581	-127.2	9.87	96.6	0.0557	34.4	0.461	-62.8
1900	0.574	-131.5	9.45	94.2	0.0559	32.8	0.441	-64.5
2000	0.567	-135.6	9.06	91.9	0.0567	32.8	0.422	-66.0
2200	0.557	-143.0	8.35	87.5	0.0589	31.4	0.389	-69.2
2400	0.551	-150.0	7.74	83.4	0.0599	30.5	0.359	-72.2
2600	0.547	-156.3	7.20	79.6	0.0612	29.5	0.333	-75.3
2800	0.546	-162.0	6.72	76.0	0.0623	29.2	0.311	-78.2
3000	0.545	-167.3	6.29	72.6	0.0640	28.1	0.291	-81.1
3200	0.546	-172.1	5.91	69.3	0.0645	28.7	0.274	-84.4
3400	0.548	-176.7	5.57	66.2	0.0654	28.1	0.259	-87.6
3600	0.548	179.2	5.26	63.2	0.0662	26.9	0.244	-90.7
3800	0.550	175.4	4.99	60.5	0.0674	27.5	0.233	-93.8
4000	0.555	171.8	4.74	57.6	0.0692	26.6	0.224	-97.3
4200	0.559	168.5	4.52	54.9	0.0716	27.0	0.216	-101.1
4400	0.563	165.4	4.31	52.2	0.0721	26.5	0.210	-104.7
4600	0.567	162.2	4.12	49.6	0.0745	26.2	0.203	-108.3
4800	0.571	159.4	3.95	47.0	0.0757	25.8	0.198	-112.0
5000	0.574	156.5	3.79	44.4	0.0772	26.1	0.193	-115.6
5200	0.578	153.7	3.64	41.8	0.0789	25.0	0.188	-119.9
5400	0.582	151.2	3.50	39.4	0.0803	25.1	0.186	-123.5
5600	0.585	148.7	3.37	36.9	0.0825	24.3	0.184	-127.2
5800	0.589	146.2	3.25	34.5	0.0837	23.8	0.181	-131.0
6000	0.593	143.8	3.14	32.0	0.0854	23.7	0.179	-135.1

S Parameter

 $(V_{CE} = 3 \text{ V}, I_C = 10 \text{ mA}, Z_O = 50 \Omega)$

f (MHz)	S11		S21		S12		S22	
	MAG	ANG	MAG	ANG	MAG	ANG	MAG	ANG
100	0.865	-11.6	26.69	170.6	0.0106	89.0	0.948	-7.9
200	0.849	-23.1	26.06	162.2	0.0121	74.5	0.957	-14.2
300	0.823	-33.9	25.09	154.5	0.0194	71.9	0.922	-20.8
400	0.795	-44.6	24.04	147.5	0.0235	71.0	0.879	-26.7
500	0.763	-54.8	22.92	140.9	0.0256	62.9	0.829	-32.3
600	0.730	-64.4	21.72	134.9	0.0296	54.9	0.779	-37.0
700	0.702	-73.0	20.42	129.5	0.0322	52.8	0.731	-41.4
800	0.674	-81.4	19.25	124.4	0.0354	49.7	0.683	-45.0
900	0.648	-89.4	18.18	119.9	0.0374	48.0	0.640	-48.3
1000	0.626	-96.5	17.09	115.7	0.0390	46.0	0.601	-51.4
1100	0.606	-103.2	16.07	111.9	0.0408	42.7	0.565	-54.0
1200	0.588	-109.6	15.17	108.3	0.0422	42.8	0.531	-56.4
1300	0.572	-115.3	14.30	105.1	0.0436	41.4	0.500	-58.7
1400	0.561	-120.6	13.51	102.1	0.0445	39.9	0.472	-60.7
1500	0.550	-125.7	12.80	99.3	0.0450	39.0	0.447	-62.6
1600	0.541	-130.6	12.14	96.7	0.0465	38.5	0.424	-64.3
1700	0.534	-134.9	11.54	94.2	0.0470	37.6	0.402	-66.1
1800	0.528	-139.1	10.99	91.9	0.0478	37.8	0.383	-67.6
1900	0.524	-143.1	10.48	89.7	0.0487	37.5	0.365	-69.4
2000	0.521	-146.9	10.01	87.6	0.0505	36.5	0.347	-70.8
2200	0.517	-153.6	9.18	83.6	0.0512	36.1	0.318	-74.1
2400	0.513	-160.0	8.46	79.9	0.0532	35.4	0.292	-77.3
2600	0.514	-165.6	7.84	76.4	0.0544	35.2	0.269	-80.5
2800	0.515	-170.7	7.30	73.2	0.0565	35.0	0.251	-83.6
3000	0.518	-175.5	6.82	70.0	0.0580	34.4	0.234	-87.0
3200	0.520	-179.8	6.40	67.0	0.0596	34.0	0.219	-90.7
3400	0.524	176.1	6.02	64.1	0.0612	34.3	0.207	-94.2
3600	0.526	172.5	5.68	61.3	0.0633	34.4	0.194	-97.9
3800	0.529	169.1	5.38	58.7	0.0656	34.8	0.185	-101.6
4000	0.535	166.0	5.11	56.1	0.0674	34.1	0.178	-105.8
4200	0.539	163.0	4.86	53.5	0.0693	34.0	0.172	-109.9
4400	0.544	160.1	4.64	50.9	0.0714	33.5	0.167	-114.5
4600	0.549	157.5	4.43	48.5	0.0740	32.7	0.163	-118.8
4800	0.553	154.8	4.24	46.0	0.0752	31.8	0.159	-122.9
5000	0.559	152.2	4.07	43.6	0.0774	31.7	0.156	-127.1
5200	0.563	149.7	3.91	41.2	0.0800	31.1	0.154	-131.7
5400	0.567	147.4	3.76	38.8	0.0824	30.5	0.153	-136.2
5600	0.571	145.0	3.62	36.4	0.0836	29.5	0.151	-140.3
5800	0.574	142.7	3.49	34.1	0.0864	29.1	0.152	-144.4
6000	0.577	140.5	3.37	31.7	0.0890	28.3	0.151	-148.8

S Parameter

 $(V_{CE} = 3 \text{ V}, I_C = 20 \text{ mA}, Z_O = 50 \Omega)$

f (MHz)	S11		S21		S12		S22	
	MAG	ANG	MAG	ANG	MAG	ANG	MAG	ANG
100	0.762	-18.1	45.58	166.7	0.0069	94.7	0.914	-11.9
200	0.731	-35.4	43.16	155.1	0.0106	75.2	0.910	-21.1
300	0.690	-51.2	39.90	144.9	0.0166	63.3	0.841	-29.8
400	0.650	-65.6	36.55	136.3	0.0194	62.3	0.767	-37.2
500	0.611	-78.6	33.26	128.7	0.0199	56.3	0.694	-43.2
600	0.577	-89.9	30.17	122.3	0.0236	53.3	0.629	-48.1
700	0.552	-99.5	27.40	117.0	0.0245	50.9	0.571	-52.2
800	0.531	-108.2	24.99	112.3	0.0265	48.7	0.521	-55.6
900	0.513	-116.0	22.90	108.2	0.0279	47.0	0.478	-58.4
1000	0.500	-122.9	21.08	104.6	0.0301	48.4	0.441	-60.9
1100	0.490	-129.0	19.48	101.4	0.0307	47.1	0.409	-63.0
1200	0.482	-134.7	18.09	98.5	0.0317	46.0	0.380	-65.1
1300	0.475	-139.5	16.85	95.8	0.0328	47.2	0.354	-67.1
1400	0.471	-144.3	15.77	93.4	0.0341	47.3	0.332	-69.0
1500	0.468	-148.5	14.81	91.1	0.0362	45.9	0.311	-70.6
1600	0.466	-152.4	13.94	88.9	0.0361	45.5	0.293	-72.0
1700	0.464	-155.9	13.17	86.9	0.0382	46.5	0.277	-73.6
1800	0.465	-159.4	12.48	85.0	0.0388	46.3	0.262	-75.3
1900	0.464	-162.5	11.84	83.1	0.0400	47.2	0.248	-77.0
2000	0.465	-165.5	11.27	81.4	0.0413	47.2	0.235	-78.7
2200	0.467	-170.8	10.27	78.1	0.0443	47.0	0.214	-82.2
2400	0.470	-175.8	9.43	74.9	0.0461	47.0	0.195	-85.9
2600	0.475	180.0	8.71	72.0	0.0486	46.4	0.179	-90.2
2800	0.480	175.8	8.08	69.1	0.0508	46.4	0.165	-94.4
3000	0.486	172.2	7.53	66.4	0.0539	46.0	0.154	-98.9
3200	0.491	168.8	7.06	63.7	0.0567	45.3	0.144	-104.7
3400	0.497	165.5	6.63	61.1	0.0585	45.4	0.135	-109.8
3600	0.501	162.5	6.24	58.7	0.0615	45.2	0.127	-114.9
3800	0.505	159.8	5.91	56.4	0.0641	44.8	0.124	-119.9
4000	0.511	157.3	5.61	54.0	0.0672	44.4	0.122	-126.0
4200	0.517	154.8	5.33	51.6	0.0701	43.3	0.120	-131.3
4400	0.523	152.6	5.08	49.2	0.0730	42.3	0.119	-137.4
4600	0.529	150.3	4.86	47.0	0.0754	41.7	0.119	-142.4
4800	0.533	148.0	4.65	44.7	0.0777	39.9	0.119	-147.4
5000	0.538	145.8	4.46	42.4	0.0808	40.0	0.120	-152.6
5200	0.543	143.6	4.28	40.2	0.0835	38.7	0.123	-157.8
5400	0.547	141.7	4.12	37.9	0.0857	37.7	0.125	-162.8
5600	0.553	139.7	3.97	35.8	0.0885	36.7	0.126	-166.5
5800	0.556	137.5	3.82	33.5	0.0910	35.7	0.129	-171.1
6000	0.561	135.6	3.69	31.3	0.0935	34.5	0.131	-175.1

S Parameter

 $(V_{CE} = 3 \text{ V}, I_C = 30 \text{ mA}, Z_O = 50 \Omega)$

f (MHz)	S11		S21		S12		S22	
	MAG	ANG	MAG	ANG	MAG	ANG	MAG	ANG
100	0.662	-23.2	58.67	164.0	0.0119	90.3	0.860	-14.7
200	0.639	-45.5	54.11	150.2	0.0092	67.3	0.868	-25.4
300	0.596	-64.6	48.37	138.8	0.0114	61.1	0.774	-35.4
400	0.559	-80.7	42.87	129.6	0.0175	58.5	0.690	-42.9
500	0.527	-94.4	37.88	122.0	0.0182	55.2	0.608	-48.8
600	0.503	-105.7	33.60	116.0	0.0207	55.0	0.542	-53.2
700	0.486	-115.3	30.01	111.0	0.0226	52.4	0.484	-56.9
800	0.472	-123.6	27.02	106.7	0.0230	52.3	0.438	-60.0
900	0.462	-130.7	24.49	103.1	0.0243	51.6	0.399	-62.4
1000	0.456	-136.8	22.38	99.9	0.0262	52.0	0.367	-64.6
1100	0.452	-142.4	20.57	97.0	0.0274	50.6	0.337	-66.6
1200	0.449	-147.3	19.00	94.4	0.0287	50.9	0.312	-68.4
1300	0.445	-151.6	17.64	92.0	0.0293	49.7	0.290	-70.1
1400	0.444	-155.6	16.46	89.8	0.0315	50.9	0.272	-71.8
1500	0.445	-159.4	15.42	87.8	0.0327	51.0	0.254	-73.4
1600	0.445	-162.6	14.48	85.8	0.0332	52.4	0.239	-74.8
1700	0.445	-165.6	13.66	84.0	0.0351	52.0	0.225	-76.5
1800	0.447	-168.6	12.93	82.3	0.0361	52.2	0.212	-78.1
1900	0.449	-171.2	12.25	80.6	0.0376	51.7	0.202	-80.1
2000	0.451	-173.8	11.65	79.0	0.0393	53.1	0.190	-82.1
2200	0.454	-178.4	10.60	75.9	0.0422	52.3	0.172	-86.0
2400	0.461	177.4	9.71	73.0	0.0447	52.5	0.156	-90.3
2600	0.466	173.6	8.96	70.2	0.0478	53.1	0.144	-94.8
2800	0.473	170.2	8.32	67.6	0.0501	50.7	0.132	-100.4
3000	0.478	167.1	7.75	65.0	0.0540	51.0	0.124	-106.1
3200	0.484	164.0	7.25	62.4	0.0566	50.9	0.117	-112.6
3400	0.491	161.0	6.81	59.9	0.0587	49.7	0.112	-118.8
3600	0.495	158.3	6.41	57.6	0.0616	49.2	0.106	-125.3
3800	0.500	156.1	6.07	55.4	0.0638	49.3	0.104	-131.4
4000	0.507	153.7	5.76	53.1	0.0679	47.9	0.104	-137.5
4200	0.513	151.5	5.48	50.8	0.0704	46.8	0.105	-143.4
4400	0.518	149.3	5.22	48.5	0.0742	45.8	0.107	-149.8
4600	0.525	147.3	4.99	46.4	0.0768	44.7	0.109	-154.9
4800	0.529	145.3	4.77	44.2	0.0799	43.9	0.110	-160.0
5000	0.534	143.1	4.57	42.0	0.0815	42.6	0.113	-165.5
5200	0.540	141.0	4.39	39.8	0.0851	41.4	0.117	-170.0
5400	0.544	139.2	4.22	37.6	0.0876	40.2	0.120	-174.4
5600	0.548	137.4	4.07	35.4	0.0906	39.4	0.124	-178.3
5800	0.553	135.4	3.93	33.3	0.0929	37.9	0.127	177.8
6000	0.556	133.4	3.79	31.1	0.0957	36.5	0.132	174.0

HSG1002 5.8GHz Evaluation Board

Evaluation Board Pattern Layout

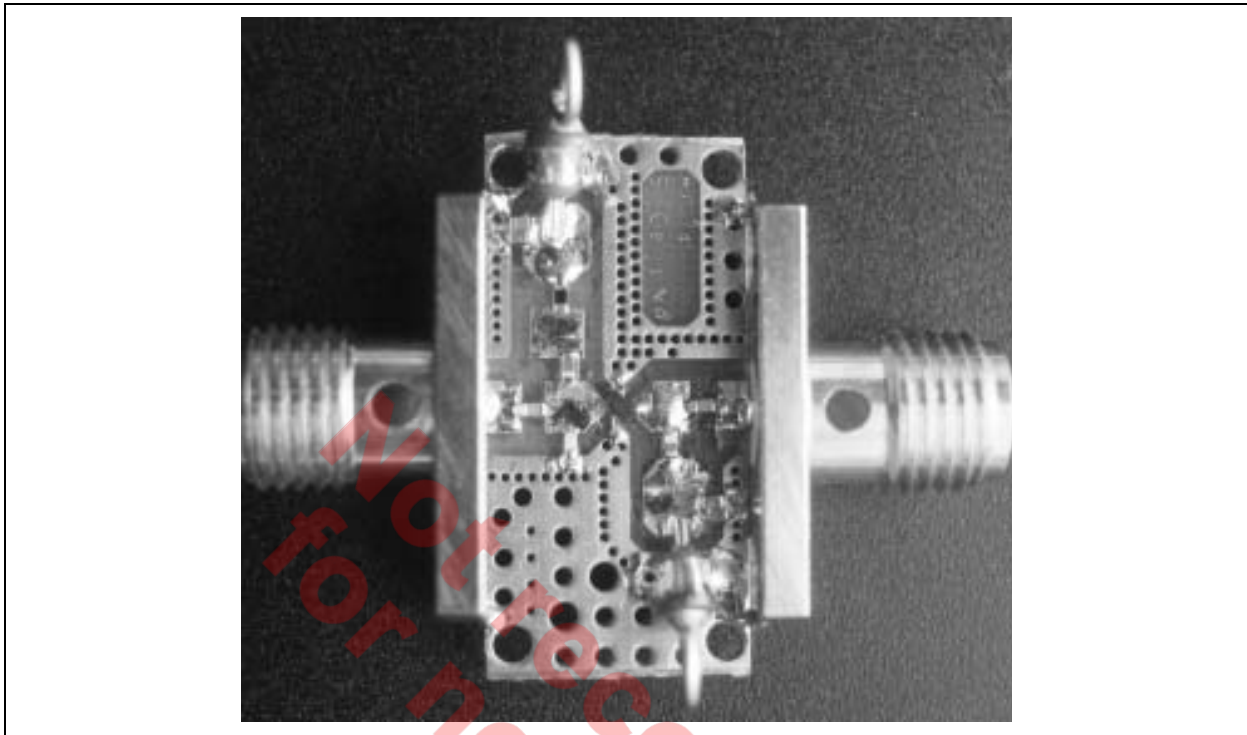

Circuit

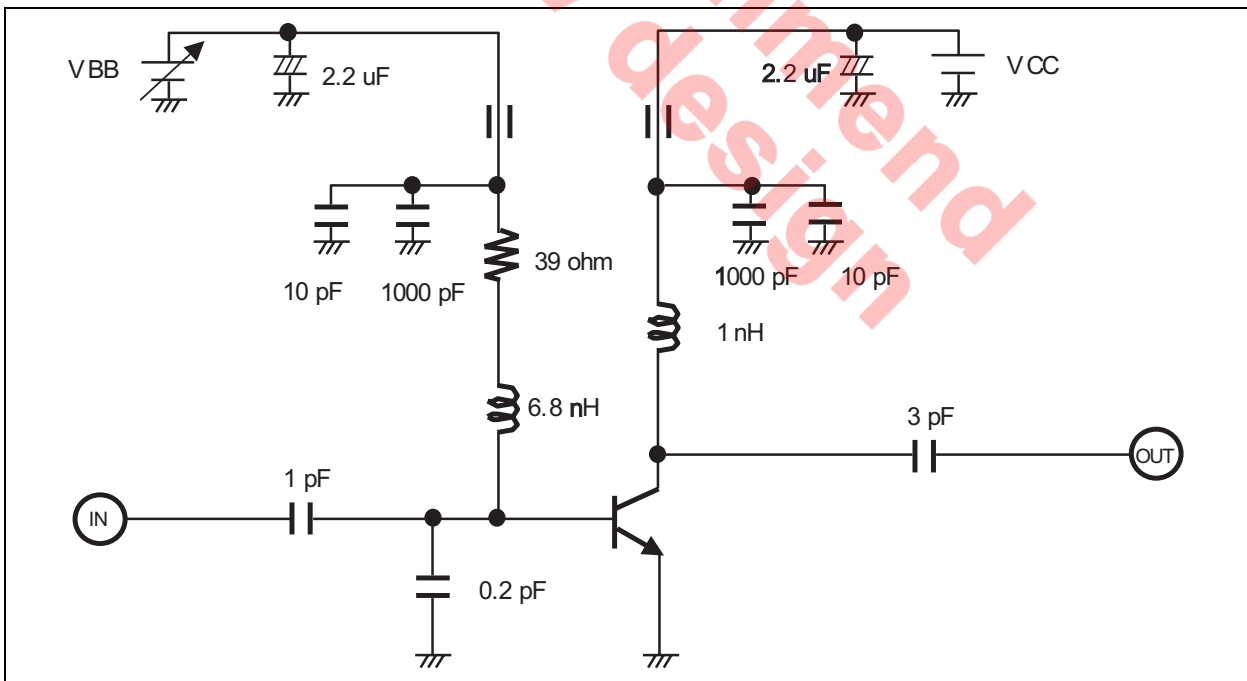

Electrical Characteristics on Evaluation Board

(VCC = 2V, IC = 10mA, Ta = 25°C)

Item	Symbol	Data	Unit	Test Condition
Noise Figure	NF	1.36	dB	f = 5.8GHz
Power Gain	PG	12.0	dB	f = 5.8GHz
Input Return Loss	RLin	8.1	dB	f = 5.8GHz
Output Return Loss	RLout	14.0	dB	f = 5.8GHz
1dB Gain Compression	P1dB	+11	dBm	f = 5.8GHz
Third order intercept point	OIP3	+25	dBm	fd = 5.8GHz, fud = 5.801GHz

Not recommend
for new design

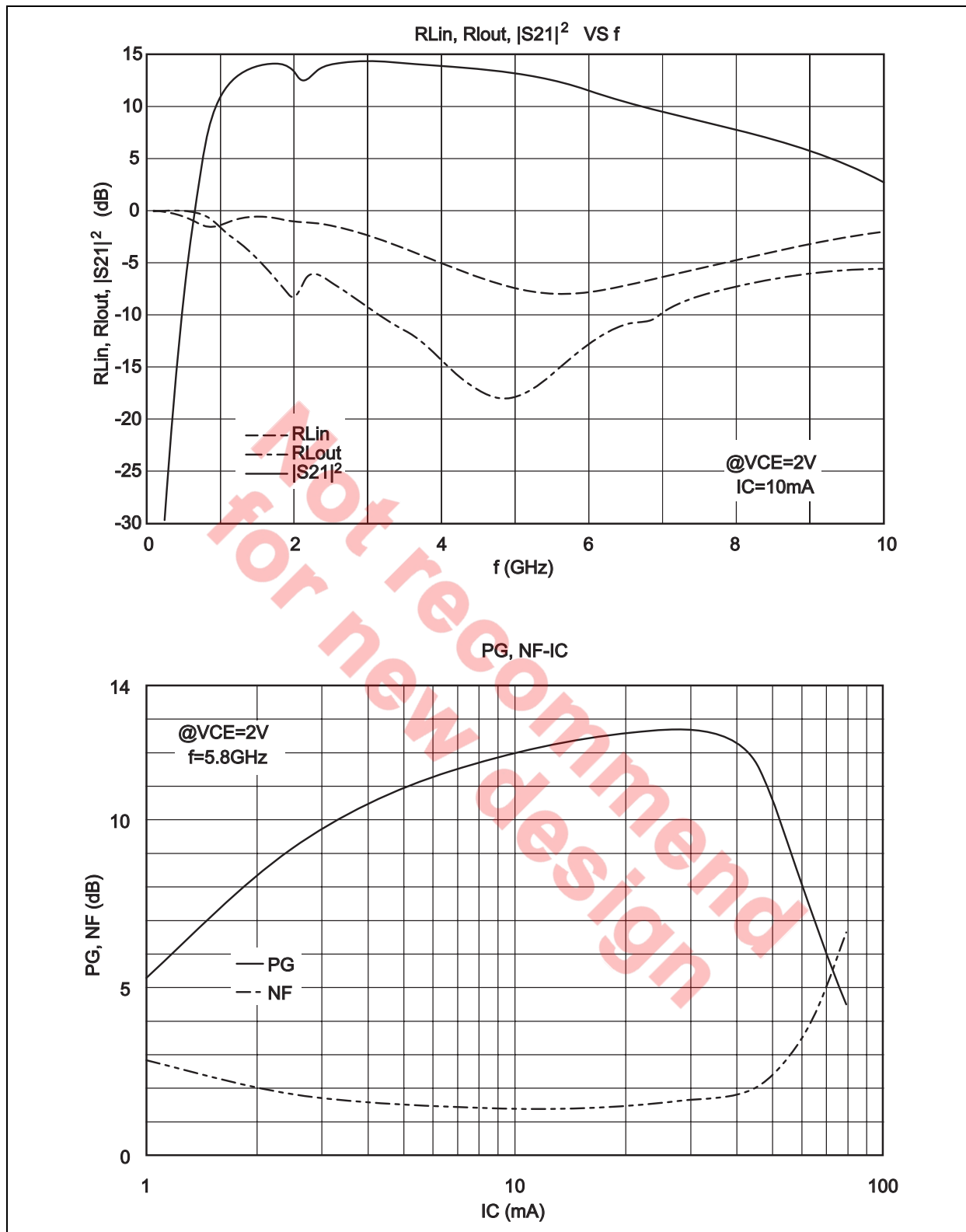

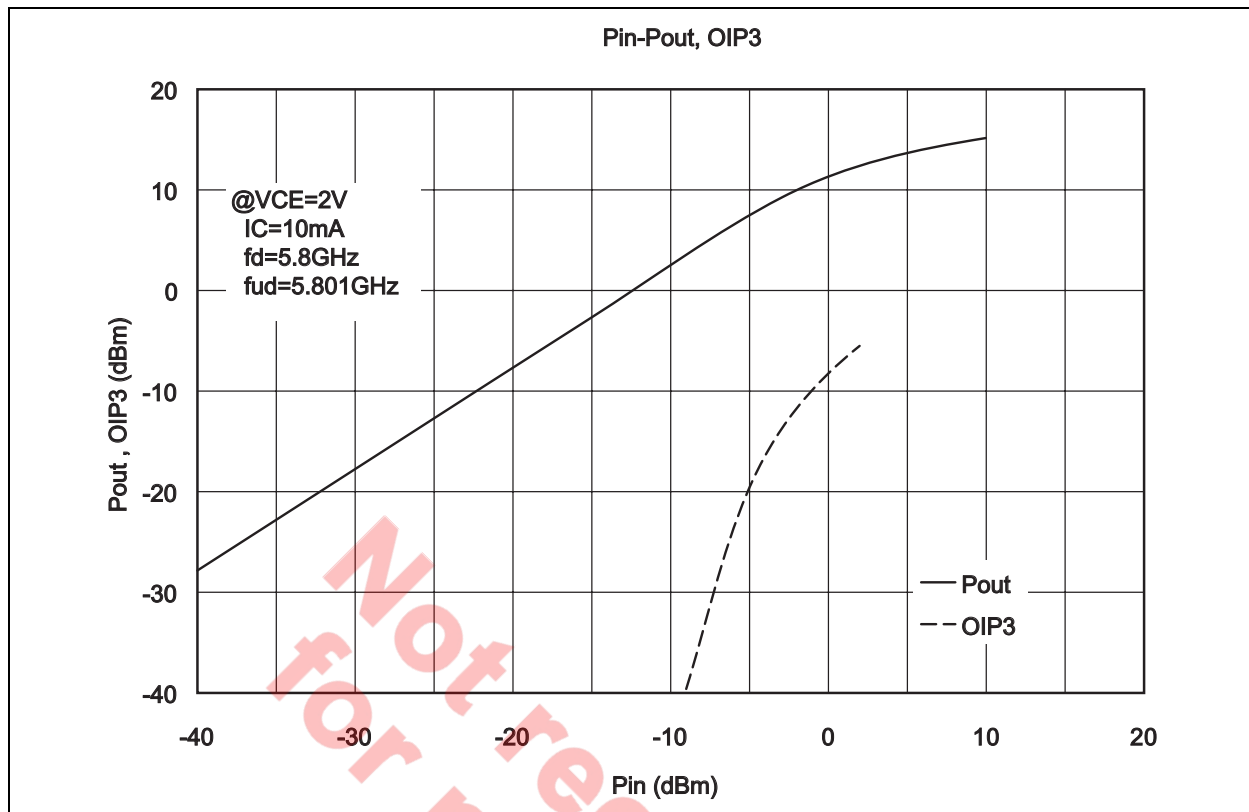

Package Dimensions

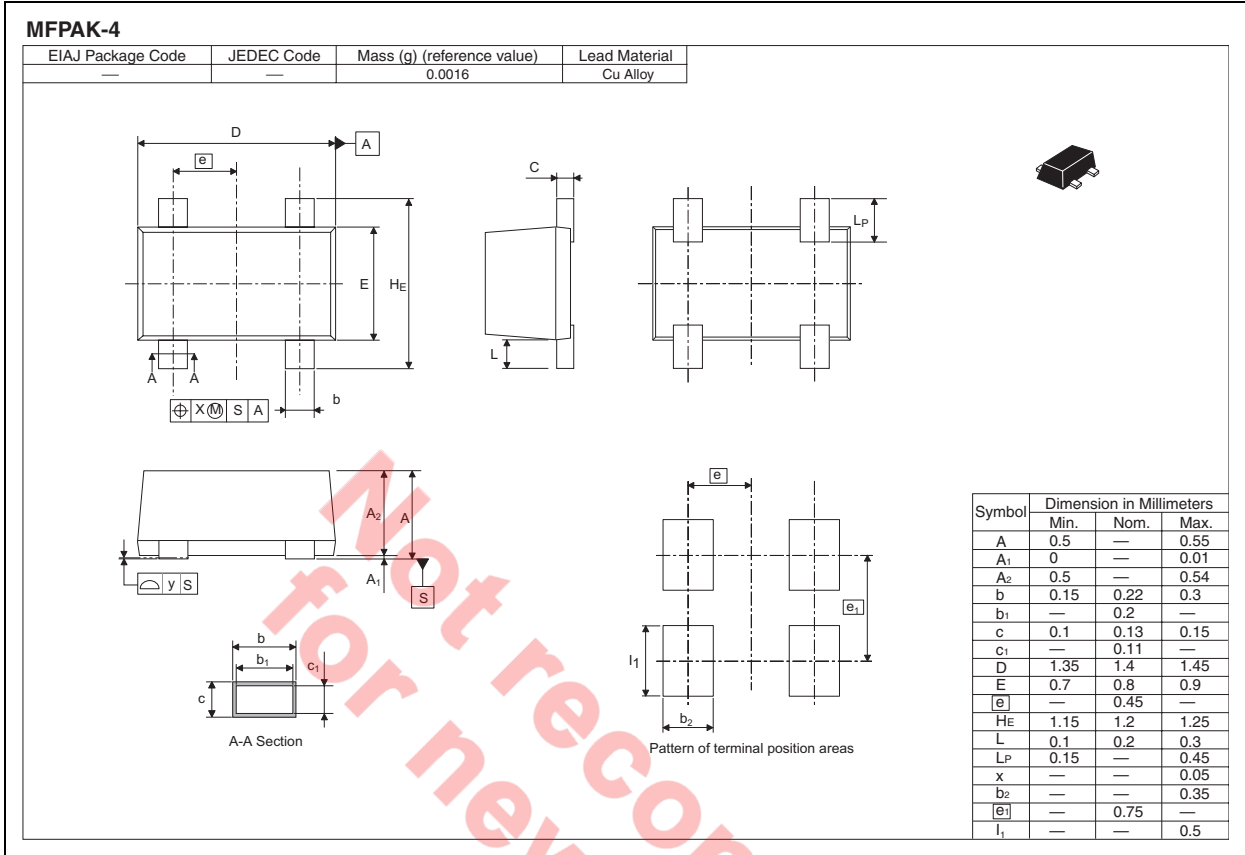

Ordering Information

Part Name	Quantity	Shipping Container
HSG1002VE-	10,000 pcs	φ178 mm Taping Reel

Note: For some grades, production may be terminated. Please contact the Renesas sales office to check the state of production before ordering the product.

Renesas Technology Corp. Sales Strategic Planning Div. Nippon Bldg., 2-6-2, Ohte-machi, Chiyoda-ku, Tokyo 100-0004, Japan

Keep safety first in your circuit designs!

1. Renesas Technology Corp. puts the maximum effort into making semiconductor products better and more reliable, but there is always the possibility that trouble may occur with them. Trouble with semiconductors may lead to personal injury, fire or property damage. Remember to give due consideration to safety when making your circuit designs, with appropriate measures such as (i) placement of substitutive, auxiliary circuits, (ii) use of nonflammable material or (iii) prevention against any malfunction or mishap.

Notes regarding these materials

1. These materials are intended as a reference to assist our customers in the selection of the Renesas Technology Corp. product best suited to the customer's application; they do not convey any license under any intellectual property rights, or any other rights, belonging to Renesas Technology Corp. or a third party.
2. Renesas Technology Corp. assumes no responsibility for any damage, or infringement of any third-party's rights, originating in the use of any product data, diagrams, charts, programs, algorithms, or circuit application examples contained in these materials.
3. All information contained in these materials, including product data, diagrams, charts, programs and algorithms represents information on products at the time of publication of these materials, and are subject to change by Renesas Technology Corp. without notice due to product improvements or other reasons. It is therefore recommended that customers contact Renesas Technology Corp. or an authorized Renesas Technology Corp. product distributor for the latest product information before purchasing a product listed herein.
The information described here may contain technical inaccuracies or typographical errors.
Renesas Technology Corp. assumes no responsibility for any damage, liability, or other loss rising from these inaccuracies or errors.
Please also pay attention to information published by Renesas Technology Corp. by various means, including the Renesas Technology Corp. Semiconductor home page (<http://www.renesas.com>).
4. When using any or all of the information contained in these materials, including product data, diagrams, charts, programs, and algorithms, please be sure to evaluate all information as a total system before making a final decision on the applicability of the information and products. Renesas Technology Corp. assumes no responsibility for any damage, liability or other loss resulting from the information contained herein.
5. Renesas Technology Corp. semiconductors are not designed or manufactured for use in a device or system that is used under circumstances in which human life is potentially at stake. Please contact Renesas Technology Corp. or an authorized Renesas Technology Corp. product distributor when considering the use of a product contained herein for any specific purposes, such as apparatus or systems for transportation, vehicular, medical, aerospace, nuclear, or undersea repeater use.
6. The prior written approval of Renesas Technology Corp. is necessary to reprint or reproduce in whole or in part these materials.
7. If these products or technologies are subject to the Japanese export control restrictions, they must be exported under a license from the Japanese government and cannot be imported into a country other than the approved destination.
Any diversion or reexport contrary to the export control laws and regulations of Japan and/or the country of destination is prohibited.
8. Please contact Renesas Technology Corp. for further details on these materials or the products contained therein.



RENESAS SALES OFFICES

<http://www.renesas.com>

Renesas Technology America, Inc.

450 Holger Way, San Jose, CA 95134-1368, U.S.A
Tel: <1> (408) 382-7500 Fax: <1> (408) 382-7501

Renesas Technology Europe Limited.

Dukes Meadow, Millboard Road, Bourne End, Buckinghamshire, SL8 5FH, United Kingdom
Tel: <44> (1628) 585 100, Fax: <44> (1628) 585 900

Renesas Technology Europe GmbH

Dornacher Str. 3, D-85622 Feldkirchen, Germany
Tel: <49> (89) 380 70 0, Fax: <49> (89) 929 30 11

Renesas Technology Hong Kong Ltd.

7/F., North Tower, World Finance Centre, Harbour City, Canton Road, Hong Kong
Tel: <852> 2265-6688, Fax: <852> 2375-6836

Renesas Technology Taiwan Co., Ltd.

FL 10, #99, Fu-Hsing N. Rd., Taipei, Taiwan
Tel: <886> (2) 2715-2888, Fax: <886> (2) 2713-2999

Renesas Technology (Shanghai) Co., Ltd.

26/F., Ruijin Building, No.205 Maoming Road (S), Shanghai 200020, China
Tel: <86> (21) 6472-1001, Fax: <86> (21) 6415-2952

Renesas Technology Singapore Pte. Ltd.

1, Harbour Front Avenue, #06-10, Keppel Bay Tower, Singapore 098632
Tel: <65> 6213-0200, Fax: <65> 6278-8001

