

DATA SHEET

BLT81 UHF power transistor

Product specification
Supersedes data of November 1992

1996 May 09

UHF power transistor

BLT81

FEATURES

- SMD encapsulation
- Gold metallization ensures excellent reliability.

APPLICATIONS

- Hand-held radio equipment in the 900 MHz communication band.

DESCRIPTION

NPN silicon planar epitaxial transistor encapsulated in a plastic SOT223 SMD package.

PINNING - SOT223

PIN	SYMBOL	DESCRIPTION
1	e	emitter
2	b	base
3	e	emitter
4	c	collector

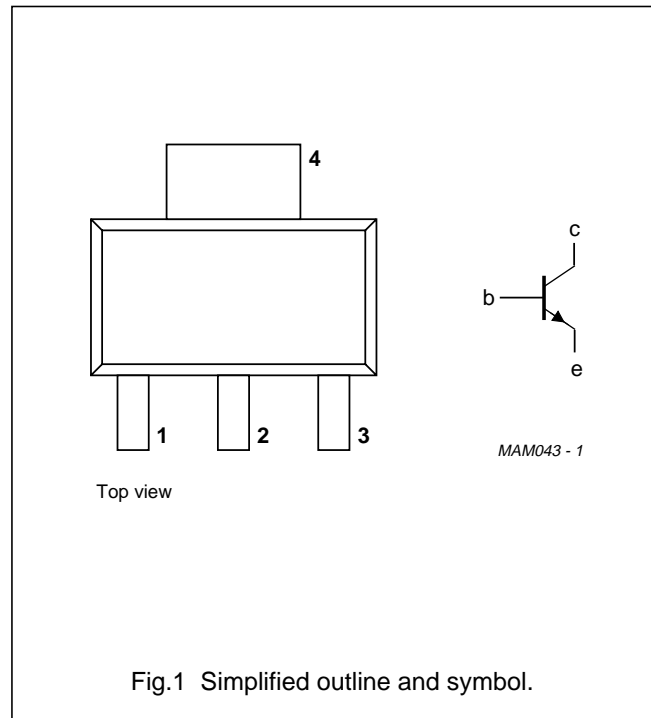

QUICK REFERENCE DATA

RF performance at $T_s \leq 60 \text{ }^\circ\text{C}$ in a common emitter test circuit (see Fig.7).

MODE OF OPERATION	f (MHz)	V _{CE} (V)	P _L (W)	G _p (dB)	η_c (%)
CW, class-B narrow band	900	7.5	1.2	≥ 6	≥ 60
		6	1.2	typ. 6.5	typ. 77

UHF power transistor

BLT81

LIMITING VALUES

In accordance with the Absolute Maximum Rating System (IEC 134).

SYMBOL	PARAMETER	CONDITIONS	MIN.	MAX.	UNIT
V_{CBO}	collector-base voltage	open emitter	–	20	V
V_{CEO}	collector-emitter voltage	open base	–	9.5	V
V_{EBO}	emitter-base voltage	open collector	–	2.5	V
I_C	collector current (DC)		–	500	mA
$I_{C(AV)}$	average collector current		–	500	mA
P_{tot}	total power dissipation	$T_s = 110\text{ °C}$; note 1	–	2	W
T_{stg}	storage temperature		–65	+150	°C
T_j	operating junction temperature		–	175	°C

THERMAL CHARACTERISTICS

SYMBOL	PARAMETER	CONDITIONS	VALUE	UNIT
$R_{th\ j-s}$	thermal resistance from junction to soldering point	$P_{tot} = 2\text{ W}$; $T_s = 110\text{ °C}$; note 1	32	K/W

Note to the “Limiting values” and “Thermal characteristics”

- T_s is the temperature at the soldering point of the collector pin.

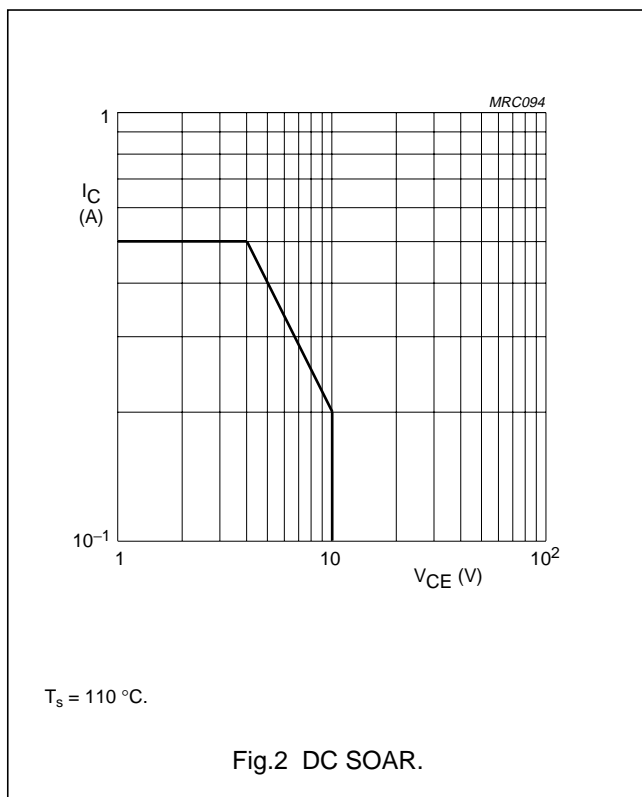

UHF power transistor

BLT81

CHARACTERISTICS

$T_j = 25\text{ }^\circ\text{C}$ unless otherwise specified.

SYMBOL	PARAMETER	CONDITIONS	MIN.	TYP.	MAX.	UNIT
$V_{(BR)CBO}$	collector-base breakdown voltage	open emitter; $I_C = 1\text{ mA}$	20	–	–	V
$V_{(BR)CEO}$	collector-emitter breakdown voltage	open base; $I_C = 10\text{ mA}$	9.5	–	–	V
$V_{(BR)EBO}$	emitter-base breakdown voltage	open collector; $I_E = 0.1\text{ mA}$	2.5	–	–	V
I_{CES}	collector leakage current	$V_{CE} = 10\text{ V}$; $V_{BE} = 0$	–	–	0.1	mA
h_{FE}	DC current gain	$V_{CE} = 5\text{ V}$; $I_C = 300\text{ mA}$; note 1;	25	–	–	
C_c	collector capacitance	$V_{CB} = 7.5\text{ V}$; $I_E = i_e = 0$; $f = 1\text{ MHz}$;	–	2.7	4	pF
C_{re}	feedback capacitance	$V_{CE} = 7.5\text{ V}$; $I_C = 0$; $f = 1\text{ MHz}$	–	1.7	3	pF

Note

1. Measured under pulsed conditions: $t_p \leq 200\text{ }\mu\text{s}$; $\delta \leq 0.02$.

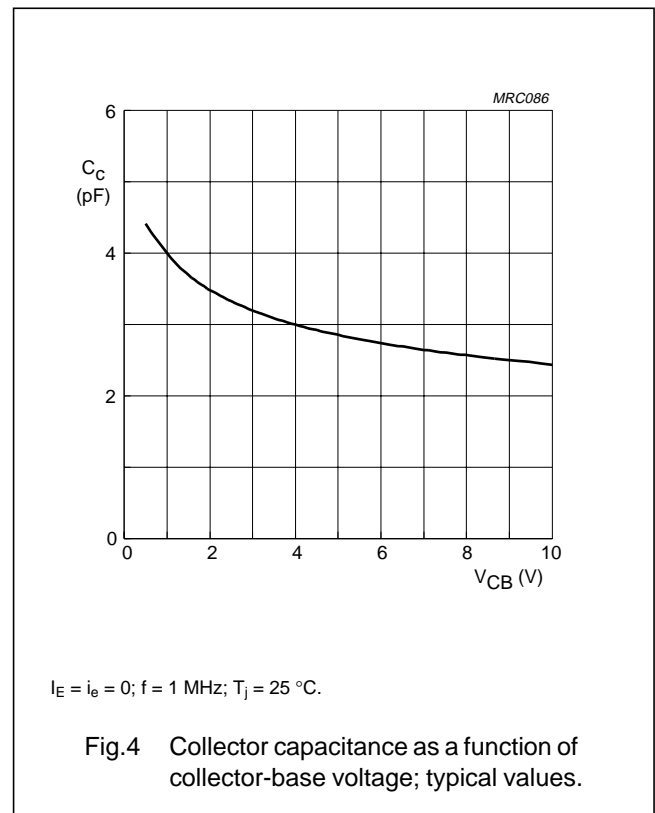
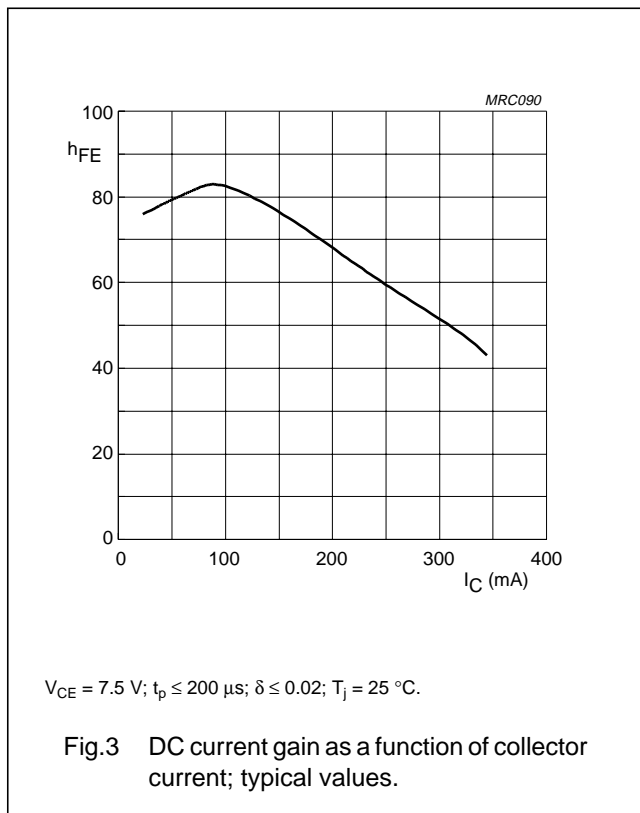

UHF power transistor

BLT81

APPLICATION INFORMATION

RF performance at $T_s \leq 60\text{ }^\circ\text{C}$ in a common emitter test circuit (see note 1 and Fig.7).

MODE OF OPERATION	f (MHz)	V _{CE} (V)	P _L (W)	G _p (dB)	η_c (%)
CW, class-B narrow band	900	7.5	1.2	≥ 6 typ. 8	≥ 60 typ. 77
		6	1.2	typ. 6.5	typ. 77

Note

- T_s is the temperature at the soldering point of the collector pin.

Ruggedness in class-AB operation

The BLT81 is capable of withstanding a load mismatch corresponding to VSWR = 50 : 1 through all phases under the following conditions: f = 900 MHz; V_{CE} = 9 V; P_L = 1.2 W; T_s ≤ 60 °C.

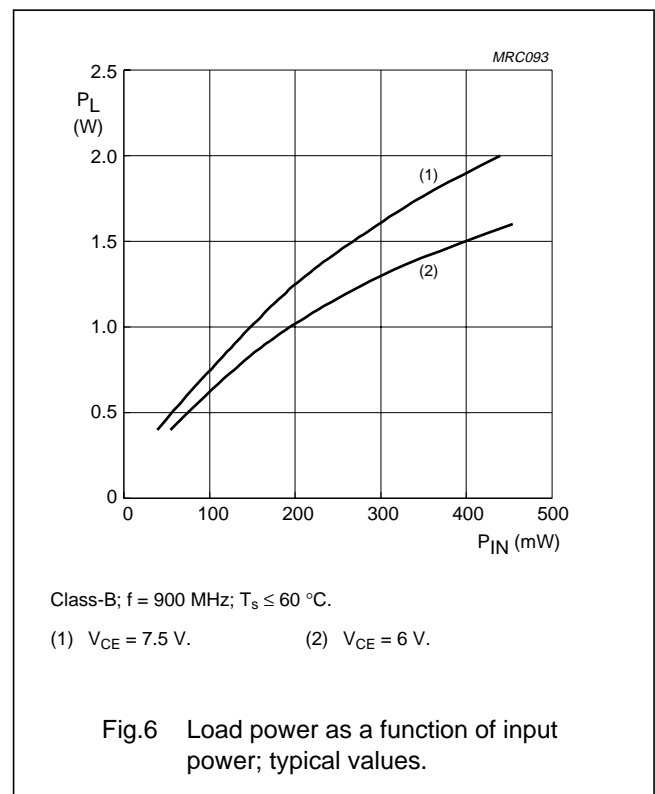
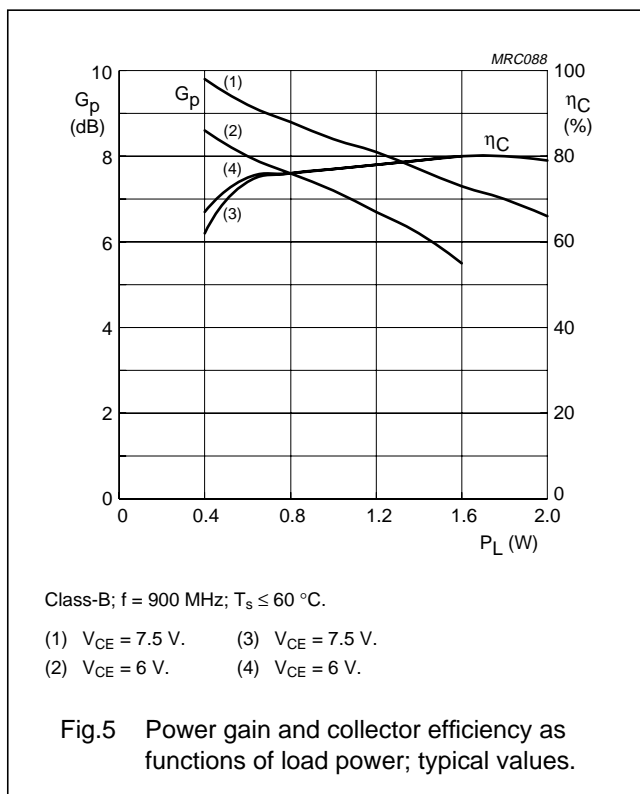

UHF power transistor

BLT81

Test circuit information

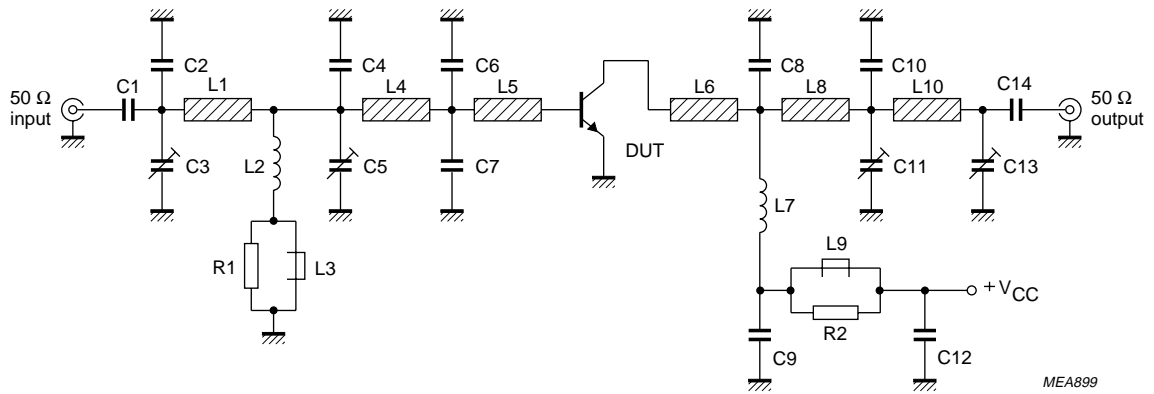

Fig.7 Common emitter test circuit for class-B operation at 900 MHz.

UHF power transistor

BLT81

List of components used in test circuit (see Figs 7 and 8)

COMPONENT	DESCRIPTION	VALUE	DIMENSIONS	CATALOGUE No.
C1, C14	multilayer ceramic chip capacitor; note 1	100 pF		
C2	multilayer ceramic chip capacitor; note 1	3 pF		
C3, C5, C11, C13	film dielectric trimmer	1.4 to 5.5 pF		2222 809 09004
C4	multilayer ceramic chip capacitor; note 1	5.6 pF		
C6, C7, C10	multilayer ceramic chip capacitor; note 1	5.1 pF		
C8	multilayer ceramic chip capacitor; note 1	3.6 pF		
C9	multilayer ceramic chip capacitor; note 1	220 pF		
C12	multilayer ceramic chip capacitor;	1 nF		
L1	stripline; note 2	50 Ω	length 26.6 mm width 4.85 mm	
L2	10 turns enamelled 0.6 mm copper wire	250 nH	int. dia. 4.5 mm leads 2 \times 5 mm	
L3, L9	grade 3B Ferroxcube wideband HF choke			4312 020 36640
L4	stripline; note 2	50 Ω	length 18 mm width 4.85 mm	
L5	stripline; note 2	75 Ω	length 3.5 mm width 2.5 mm	
L6	stripline; note 2	50 Ω	length 10 mm width 4.85 mm	
L7	4 turns enamelled 0.6 mm copper wire	65 nH	int. dia. 4.5 mm leads 2 \times 5 mm	
L8	stripline; note 2	50 Ω	length 15 mm width 4.85 mm	
L10	stripline; note 2	50 Ω	length 24.6 mm width 4.85 mm	
R1, R2	metal film resistor	10 Ω , 0.25 W		

Notes

- American Technical Ceramics type 100B or capacitor of same quality.
- The striplines are on a double copper-clad printed-circuit board, with PTFE fibre-glass dielectric ($\epsilon_r = 2.2$); thickness $\frac{1}{16}$ " ; thickness of the copper sheet 35 μm .

UHF power transistor

BLT81

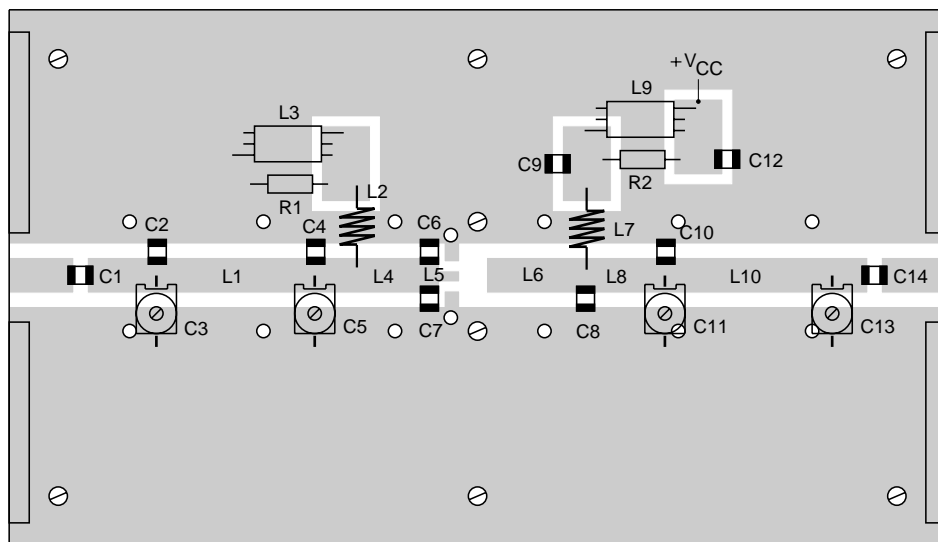
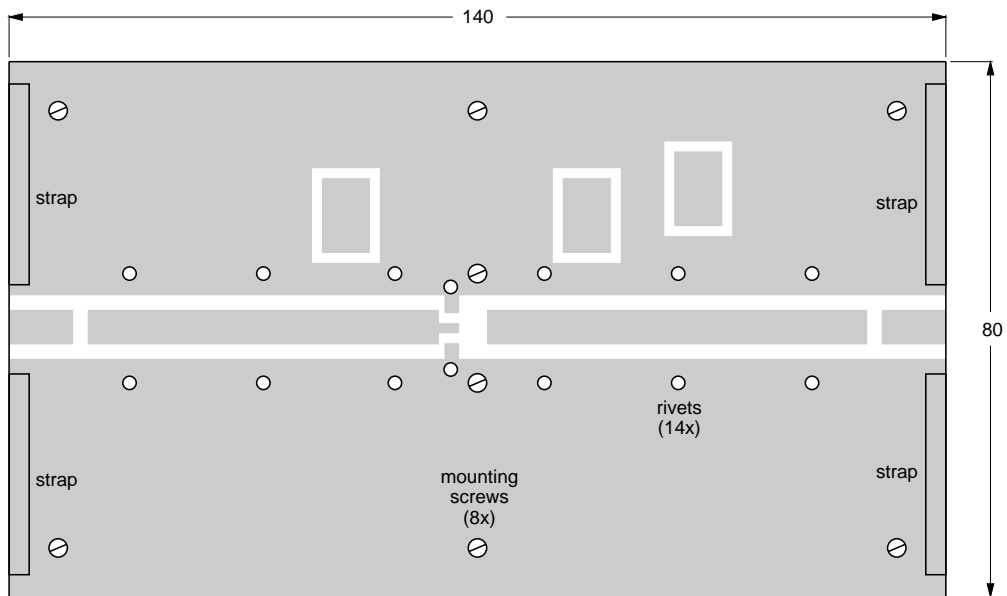

MEA898

Dimensions in mm.

The components are situated on one side of the copper-clad PTFE fibre-glass board, the other side is unetched and serves as a ground plane. Earth connections from the component side to the ground plane are made by means of fixing screws and copper foil straps under the emitter leads.

Fig.8 Printed-circuit board and component lay-out for 900 MHz class-B test circuit in Fig.7.

UHF power transistor

BLT81

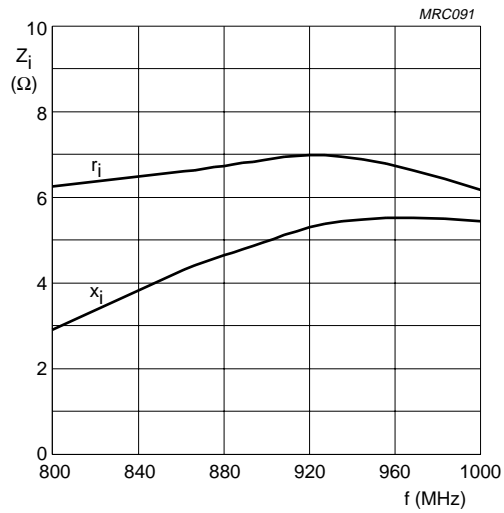

Class-B; $V_{CE} = 7.5$ V; $P_L = 1.2$ W; $T_s \leq 60$ °C.

Fig. 9 Input impedance as a function of frequency (series components); typical values.

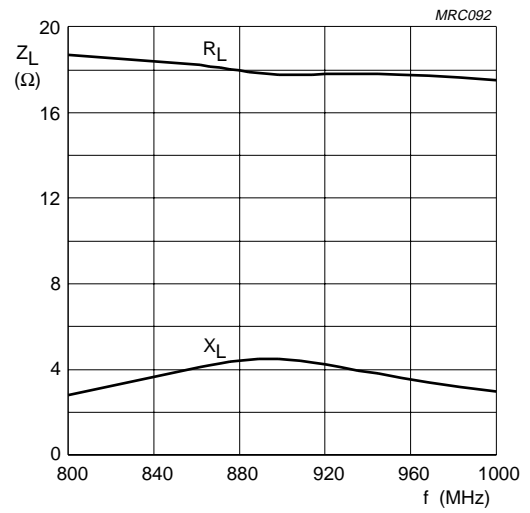

Class-B; $V_{CE} = 7.5$ V; $P_L = 1.2$ W; $T_s \leq 60$ °C.

Fig. 10 Load impedance as a function of frequency (series components); typical values.

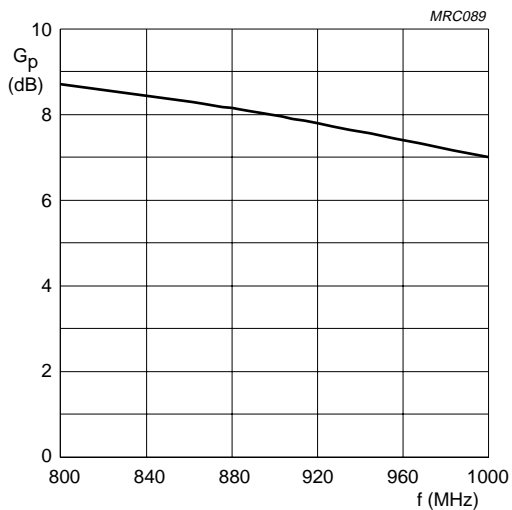

Class-B; $V_{CE} = 7.5$ V; $P_L = 1.2$ W; $T_s \leq 60$ °C.

Fig. 11 Power gain as a function of frequency; typical values.

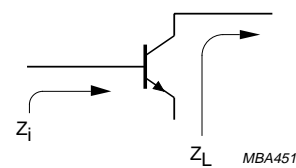
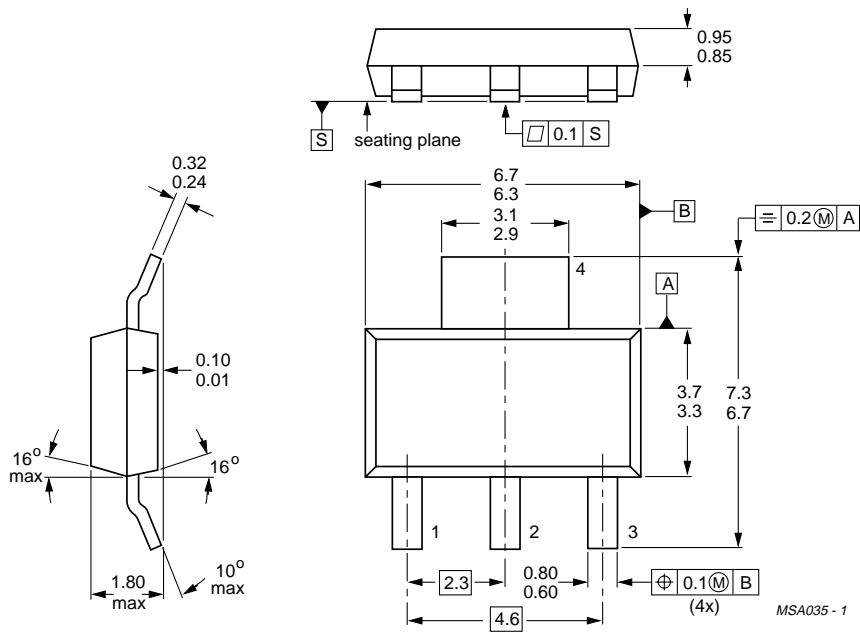

Fig. 12 Definition of transistor impedance.

UHF power transistor

BLT81

PACKAGE OUTLINE



Dimensions in mm.

Fig.13 SOT223.

UHF power transistor

BLT81

DEFINITIONS

Data Sheet Status	
Objective specification	This data sheet contains target or goal specifications for product development.
Preliminary specification	This data sheet contains preliminary data; supplementary data may be published later.
Product specification	This data sheet contains final product specifications.
Limiting values	
Limiting values given are in accordance with the Absolute Maximum Rating System (IEC 134). Stress above one or more of the limiting values may cause permanent damage to the device. These are stress ratings only and operation of the device at these or at any other conditions above those given in the Characteristics sections of the specification is not implied. Exposure to limiting values for extended periods may affect device reliability.	
Application information	
Where application information is given, it is advisory and does not form part of the specification.	

LIFE SUPPORT APPLICATIONS

These products are not designed for use in life support appliances, devices, or systems where malfunction of these products can reasonably be expected to result in personal injury. Philips customers using or selling these products for use in such applications do so at their own risk and agree to fully indemnify Philips for any damages resulting from such improper use or sale.

Philips Semiconductors – a worldwide company

Argentina: see South America

Australia: 34 Waterloo Road, NORTH RYDE, NSW 2113,
Tel. (02) 805 4455, Fax. (02) 805 4466

Austria: Computerstr. 6, A-1101 WIEN, P.O. Box 213,
Tel. (01) 60 101-1256, Fax. (01) 60 101-1250

Belarus: Hotel Minsk Business Center, Bld. 3, r. 1211,
Volodarski Str. 6, 220050 MINSK,
Tel. (172) 200 733, Fax. (172) 200 773

Belgium: see The Netherlands

Brazil: see South America

Bulgaria: Philips Bulgaria Ltd., Energoproject, 15th floor,
51 James Bourchier Blvd., 1407 SOFIA,
Tel. (359) 2 689 211, Fax. (359) 2 689 102

Canada: PHILIPS SEMICONDUCTORS/COMPONENTS:
Tel. (800) 234-7381, Fax. (708) 296-8556

Chile: see South America

China/Hong Kong: 501 Hong Kong Industrial Technology Centre,
72 Tat Chee Avenue, Kowloon Tong, HONG KONG,
Tel. (852) 2319 7888, Fax. (852) 2319 7700

Colombia: see South America

Czech Republic: see Austria

Denmark: Prags Boulevard 80, PB 1919, DK-2300
COPENHAGEN S, Tel. (032) 88 2636, Fax. (031) 57 1949

Finland: Sinikalliontie 3, FIN-02630 ESPOO,
Tel. (358) 0-615 800, Fax. (358) 0-61580 920

France: 4 Rue du Port-aux-Vins, BP317,
92156 SURESNES Cedex,
Tel. (01) 4099 6161, Fax. (01) 4099 6427

Germany: P.O. Box 10 51 40, 20035 HAMBURG,
Tel. (040) 23 53 60, Fax. (040) 23 53 63 00

Greece: No. 15, 25th March Street, GR 17778 TAVROS,
Tel. (01) 4894 339/4894 911, Fax. (01) 4814 240

Hungary: see Austria

India: Philips INDIA Ltd, Shivsagar Estate, A Block,
Dr. Annie Besant Rd. Worli, BOMBAY 400 018
Tel. (022) 4938 541, Fax. (022) 4938 722

Indonesia: see Singapore

Ireland: Newstead, Clonskeagh, DUBLIN 14,
Tel. (01) 7640 000, Fax. (01) 7640 200

Israel: RAPAC Electronics, 7 Kehilat Saloniki St, TEL AVIV 61180,
Tel. (03) 645 04 44, Fax. (03) 648 10 07

Italy: PHILIPS SEMICONDUCTORS,
Piazza IV Novembre 3, 20124 MILANO,
Tel. (0039) 2 6752 2531, Fax. (0039) 2 6752 2557

Japan: Philips Bldg 13-37, Kohnan 2-chome, Minato-ku,
TOKYO 108, Tel. (03) 3740 5130, Fax. (03) 3740 5077

Korea: Philips House, 260-199 Itaewon-dong,
Yongsan-ku, SEOUL, Tel. (02) 709-1412, Fax. (02) 709-1415

Malaysia: No. 76 Jalan Universiti, 46200 PETALING JAYA,
SELANGOR, Tel. (03) 750 5214, Fax. (03) 757 4880

Mexico: 5900 Gateway East, Suite 200, EL PASO,
TEXAS 79905, Tel. 9-5(800) 234-7831, Fax. (708) 296-8556

Middle East: see Italy

Netherlands: Postbus 90050, 5600 PB EINDHOVEN, Bldg. VB,
Tel. (040) 2783749, Fax. (040) 2788399

New Zealand: 2 Wagener Place, C.P.O. Box 1041, AUCKLAND,
Tel. (09) 849-4160, Fax. (09) 849-7811

Norway: Box 1, Manglerud 0612, OSLO,
Tel. (022) 74 8000, Fax. (022) 74 8341

Philippines: PHILIPS SEMICONDUCTORS PHILIPPINES Inc.,
106 Valero St. Salcedo Village, P.O. Box 2108 MCC,
MAKATI, Metro MANILA,
Tel. (63) 2 816 6380, Fax. (63) 2 817 3474

Poland: Ul. Lukiska 10, PL 04-123 WARSZAWA,
Tel. (022) 612 2831, Fax. (022) 612 2327

Portugal: see Spain

Romania: see Italy

Singapore: Lorong 1, Toa Payoh, SINGAPORE 1231,
Tel. (65) 350 2000, Fax. (65) 251 6500

Slovakia: see Austria

Slovenia: see Italy

South Africa: S.A. PHILIPS Pty Ltd.,
195-215 Main Road Martindale, 2092 JOHANNESBURG,
P.O. Box 7430 Johannesburg 2000,
Tel. (011) 470-5911, Fax. (011) 470-5494

South America: Rua do Rocio 220 - 5th floor, Suite 51,
CEP: 04552-903-SÃO PAULO-SP, Brazil,
P.O. Box 7383 (01064-970),
Tel. (011) 821-2333, Fax. (011) 829-1849

Spain: Balmes 22, 08007 BARCELONA,
Tel. (03) 301 6312, Fax. (03) 301 4107

Sweden: Kottbygatan 7, Akalla. S-16485 STOCKHOLM,
Tel. (0) 8-632 2000, Fax. (0) 8-632 2745

Switzerland: Allmendstrasse 140, CH-8027 ZÜRICH,
Tel. (01) 488 2211, Fax. (01) 481 77 30

Taiwan: PHILIPS TAIWAN Ltd., 23-30F, 66,
Chung Hsiao West Road, Sec. 1, P.O. Box 22978,
TAIPEI 100, Tel. (886) 2 382 4443, Fax. (886) 2 382 4444

Thailand: PHILIPS ELECTRONICS (THAILAND) Ltd.,
209/2 Sanpavuth-Bangna Road Prakanong, BANGKOK 10260,
Tel. (66) 2 745-4090, Fax. (66) 2 398-0793

Turkey: Talatpasa Cad. No. 5, 80640 GÜLTEPE/ISTANBUL,
Tel. (0212) 279 2770, Fax. (0212) 282 6707

Ukraine: PHILIPS UKRAINE,
2A Akademika Koroleva str., Office 165, 252148 KIEV,
Tel. 380-44-4760297, Fax. 380-44-4766991

United Kingdom: Philips Semiconductors LTD.,
276 Bath Road, Hayes, MIDDLESEX UB3 5BX,
Tel. (0181) 730-5000, Fax. (0181) 754-8421

United States: 811 East Arques Avenue, SUNNYVALE,
CA 94088-3409, Tel. (800) 234-7381, Fax. (708) 296-8556

Uruguay: see South America

Vietnam: see Singapore

Yugoslavia: PHILIPS, Trg N. Pasica 5/v, 11000 BEOGRAD,
Tel. (381) 11 825 344, Fax. (359) 211 635 777

Internet: <http://www.semiconductors.philips.com/ps/>

For all other countries apply to: Philips Semiconductors,
Marketing & Sales Communications, Building BE-p,
P.O. Box 218, 5600 MD EINDHOVEN, The Netherlands,
Fax. +31-40-2724825

SCDS48

© Philips Electronics N.V. 1996

All rights are reserved. Reproduction in whole or in part is prohibited without the prior written consent of the copyright owner.

The information presented in this document does not form part of any quotation or contract, is believed to be accurate and reliable and may be changed without notice. No liability will be accepted by the publisher for any consequence of its use. Publication thereof does not convey nor imply any license under patent- or other industrial or intellectual property rights.

Printed in The Netherlands

127061/1200/02/pp12
Document order number:

Date of release: 1996 May 09
9397 750 00835