

N-CHANNEL GaAs MES FET NE960R5 SERIES

0.5 W X, Ku-BAND POWER GaAs MES FET

DESCRIPTION

The NE960R5 Series are 0.5 W GaAs MES FETs designed for middle power transmitter applications for X, Ku-band microwave communication systems. It is capable of delivering 0.5 watt of output power (CW) with high linear gain, high efficiency and low distortion and are suitable as driver amplifiers for our X, Ku-band NEZ Series amplifiers etc. The NE961R500 and the NE960R500 are available in chip form. The NE960R500 has a via hole source grounding and PHS (Plated Heat Sink) for superior RF performance. The NE960R575 and the NE962R575 are available in a hermetically sealed ceramic package. The NE962R575 is suitable for oscillator application. Reliability and performance uniformity are assured by NEC's stringent quality and control procedures.

FEATURES

- High Output Power : P_o (1 dB) = +27.5 dBm TYP.
- High Linear Gain : 9.0 dB TYP.
- High Power Added Efficiency: 30 % TYP. @ $V_{DS} = 9$ V, $I_{Dset} = 180$ mA, $f = 14.5$ GHz

ORDERING INFORMATION

Part Number	Package	Supplying Form
NE960R500	00 (CHIP)	ESD protective envelope
NE961R500		
NE960R575	75	
NE962R575		

Remark To order evaluation samples, please contact your local NEC sales office.
(Part number for sample order: NE960R500, NE960R575, NE961R500, NE962R575)

Caution Please handle this device at static-free workstation, because this is an electrostatic sensitive device.

The information in this document is subject to change without notice. Before using this document, please confirm that this is the latest version.
Not all devices/types available in every country. Please check with local NEC representative for availability and additional information.

ABSOLUTE MAXIMUM RATINGS (T_A = +25°C)

Operation in excess of any one of these parameters may result in permanent damage.

Parameter	Symbol	Ratings	Unit
Drain to Source Voltage	V _{DS}	15	V
Gate to Source Voltage	V _{GSO}	-7 (-9 ^{Note 1})	V
Drain Current	I _D	0.7	A
Gate Forward Current	I _{GF}	+5.0	mA
Gate Reverse Current	I _{GR}	-5.0	mA
Total Power Dissipation	P _T	5.0 (4.2 ^{Note 2})	W
Channel Temperature	T _{ch}	175	°C
Storage Temperature	T _{stg}	-65 to +175	°C

- Notes** 1. NE962R575
 2. NE961R500

RECOMMENDED OPERATING CONDITIONS

Parameter	Symbol	Test Condition	MIN.	TYP.	MAX.	Unit
Drain to Source Voltage	V _{DS}		-	9.0	9.0	V
Gain Compression	G _{comp}		-	-	3.0	dB
Channel Temperature	T _{ch}		-	-	+130	°C

ELECTRICAL CHARACTERISTICS

(T_A = +25°C, unless otherwise specified, using NEC standard test fixture.)

Parameter	Symbol	Test Conditions	MIN.	TYP.	MAX.	Unit
Saturated Drain Current	I _{DSS}	V _{DS} = 1.5 V, V _{GS} = 0 V	0.18	0.4	0.7	A
Pinch-off Voltage	V _p	V _{DS} = 2.5 V, I _D = 2 mA	-2.5	-1.8	-0.5	V
Gate to Drain Break Down Voltage ^{Note 1}	BV _{gd}	I _{gd} = 2 mA	15	-	-	V
Gate to Source Break Down Voltage ^{Note 2}	BV _{gs}	I _{gs} = 2 mA	9.0	-	-	V
Thermal Resistance	R _{th}	Channel to Case	-	-	30 (35 ^{Note 3})	°C/W
Output Power at P _{in} = +19 dBm	P _{out}	f = 14.5 GHz, V _{DS} = 9.0 V	25.5	26.5	-	dBm
Output Power at 1 dB Gain Compression Point ^{Note 1}	P _{o (1 dB)}	R _g = 1 kΩ I _{Dset} = 180 mA (RF OFF)	-	27.5	-	dBm
Power Added Efficiency at P _{o (1dB)} ^{Note 1}	η _{add}		-	30	-	%
Linear Gain ^{Note 1}	G _L		8.0	9.0	-	dB

- Notes** 1. Except NE962R575
 2. NE962R575 only
 3. NE961R500

Remark DC and RF performance is 100 % testing.

TYPICAL CHARACTERISTICS (T_A = +25°C)

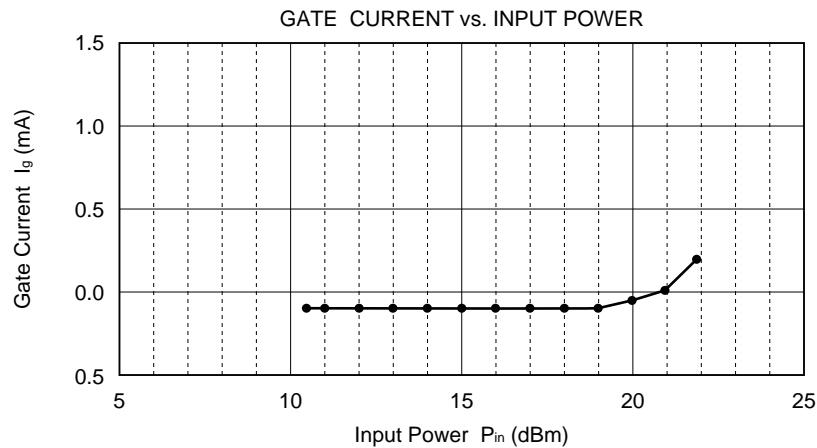
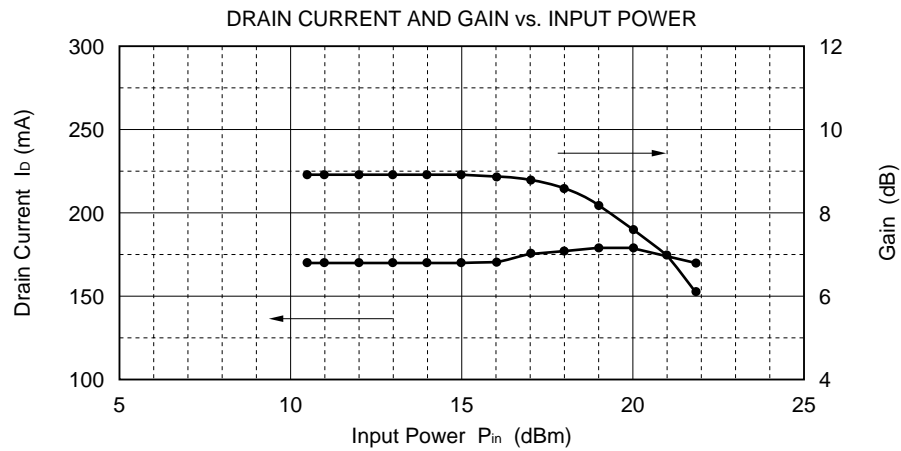
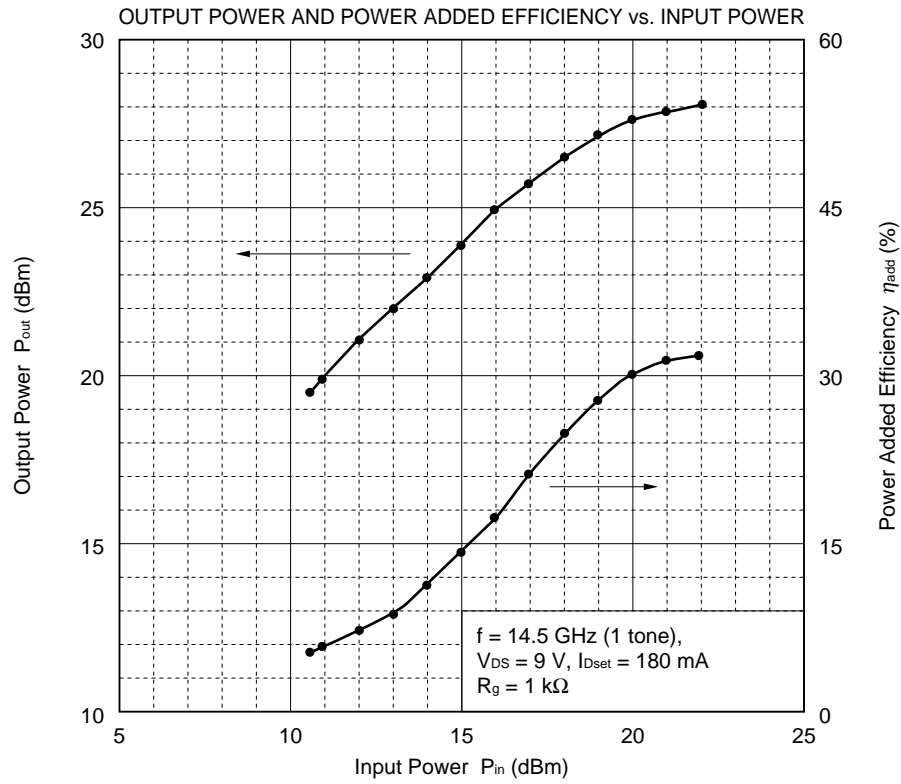

TYPICAL S-PARAMETER
[NE960R575]

TEST CONDITIONS: $V_{DS} = 9\text{ V}$, $I_{Dset} = 180\text{ mA}$

FREQUENCY GHz	S ₁₁		S ₂₁		S ₁₂		S ₂₂	
	MAG.	ANG. (deg.)	MAG.	ANG. (deg.)	MAG.	ANG. (deg.)	MAG.	ANG. (deg.)
2.0	0.87	-140	4.36	85	0.042	23	0.23	-131
3.0	0.84	-154	2.98	68	0.040	19	0.25	-143
4.0	0.84	-160	2.36	54	0.040	22	0.30	-149
5.0	0.82	-163	2.08	42	0.043	32	0.32	-154
6.0	0.81	-167	1.99	33	0.047	34	0.34	-160
7.0	0.79	-175	1.96	18	0.055	35	0.36	-168
8.0	0.73	171	2.02	1	0.066	30	0.36	178
9.0	0.69	147	2.20	-20	0.076	18	0.37	159
10.0	0.62	109	2.30	-51	0.083	-4	0.38	136
11.0	0.63	47	2.22	-88	0.063	-41	0.45	95
12.0	0.76	0	1.62	-124	0.032	-82	0.57	65
13.0	0.79	-21	1.30	-144	0.017	-141	0.61	49
14.0	0.87	-45	0.90	-172	0.022	128	0.66	27
15.0	0.87	-53	0.60	166	0.034	101	0.73	11
16.0	0.83	-60	0.43	150	0.037	82	0.75	-2

START 2 GHz, STOP 16 GHz, STEP 1 GHz

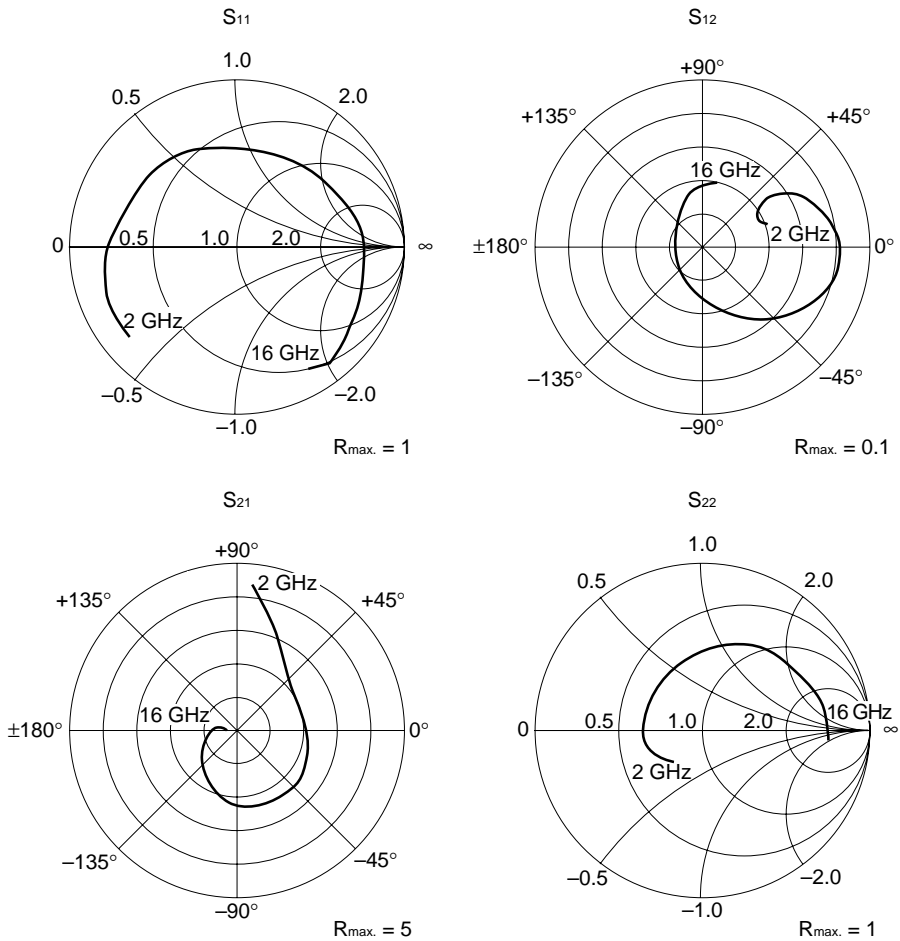

[NE960R500]

TEST CONDITIONS: $V_{DS} = 9\text{ V}$, $I_{Dset} = 180\text{ mA}$

FREQUENCY GHz	S ₁₁		S ₂₁		S ₁₂		S ₂₂	
	MAG.	ANG. (deg.)	MAG.	ANG. (deg.)	MAG.	ANG. (deg.)	MAG.	ANG. (deg.)
2.0	0.87	-132	6.53	160	0.038	90	0.23	-105
3.0	0.85	-146	4.06	-168	0.037	120	0.25	-118
4.0	0.85	-155	2.74	-148	0.038	155	0.29	-124
5.0	0.86	-158	2.24	-121	0.038	-177	0.34	-131
6.0	0.86	-161	1.89	-93	0.037	-137	0.39	-133
7.0	0.85	-162	1.62	-66	0.033	-109	0.44	-135
8.0	0.84	-163	1.32	-40	0.032	-64	0.48	-137
9.0	0.85	-165	1.24	-11	0.039	-35	0.53	-138
10.0	0.86	-170	1.12	16	0.032	5	0.56	-139
11.0	0.86	-174	1.04	43	0.032	47	0.58	-142
12.0	0.85	179	0.94	64	0.041	78	0.61	-146
13.0	0.85	172	0.83	86	0.025	108	0.63	-149
14.0	0.87	172	0.65	114	0.038	153	0.65	-153
15.0	0.86	170	0.60	152	0.028	171	0.65	-157
16.0	0.87	167	0.57	-178	0.032	-142	0.68	-159
17.0	0.87	167	0.54	-150	0.032	-98	0.67	-164
18.0	0.87	163	0.40	-122	0.045	-80	0.67	-175

Caution S-parameters include bond wires.

Gate : Total 2 wires, 1 per bond pad, 300 μm long each wire.

Drain : Total 2 wires, 1 per bond pad, 300 μm long each wire.

Source: No bond wires.

Wire : 25 μm diameter, gold.

[NE961R500]

TEST CONDITIONS: $V_{DS} = 9\text{ V}$, $I_{Dset} = 180\text{ mA}$

FREQUENCY GHz	S ₁₁		S ₂₁		S ₁₂		S ₂₂	
	MAG.	ANG. (deg.)	MAG.	ANG. (deg.)	MAG.	ANG. (deg.)	MAG.	ANG. (deg.)
2.0	0.81	-134	6.37	163	0.040	105	0.17	-90
3.0	0.79	-149	3.73	-170	0.042	140	0.18	-107
4.0	0.78	-159	2.64	-151	0.047	-176	0.20	-118
5.0	0.79	-164	2.18	-125	0.053	-140	0.24	-127
6.0	0.78	-168	1.83	-97	0.060	-99	0.29	-132
7.0	0.77	-168	1.58	-69	0.061	-67	0.34	-136
8.0	0.76	-171	1.32	-43	0.072	-18	0.38	-138
9.0	0.76	-175	1.24	-14	0.098	6	0.43	-139
10.0	0.76	178	1.14	13	0.097	49	0.47	-139
11.0	0.77	171	1.03	40	0.112	85	0.50	-141
12.0	0.77	164	0.94	65	0.153	113	0.53	-145
13.0	0.79	160	0.87	89	0.111	146	0.56	-149
14.0	0.81	155	0.69	116	0.189	-178	0.57	-156
15.0	0.81	153	0.68	153	0.145	-161	0.58	-161
16.0	0.81	151	0.64	-176	0.192	-119	0.58	-166
17.0	0.80	148	0.62	-149	0.205	-81	0.58	-174
18.0	0.81	144	0.47	-114	0.267	-69	0.58	175

Caution S-parameters include bond wires.

- Gate** : Total 2 wires, 1 per bond pad, 300 μm long each wire.
- Drain** : Total 2 wires, 1 per bond pad, 300 μm long each wire.
- Source** : Total 4 wires, 1 per bond pad, 300 μm long each wire.
- Wire** : 25 μm diameter, gold.

PACKAGE DIMENSIONS

PACKAGE CODE-75 (Unit: mm)

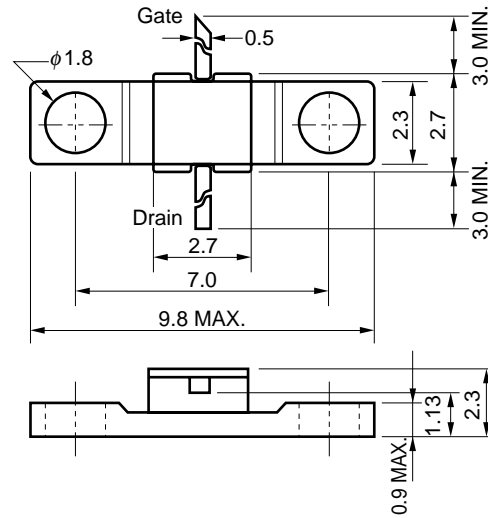

PHYSICAL DIMENSIONS

NE960R500 (CHIP) (Unit: μm)

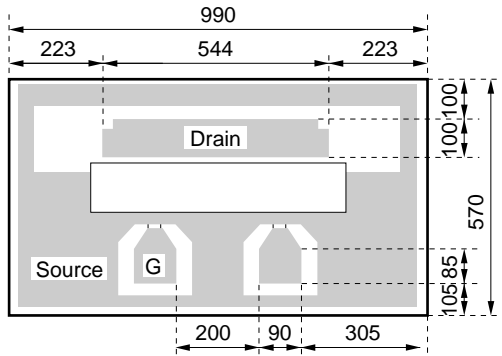

Remark Chip thickness: 100 μm
 G : Gate
 Source is grounded through via hole.

NE961R500 (CHIP) (Unit: μm)

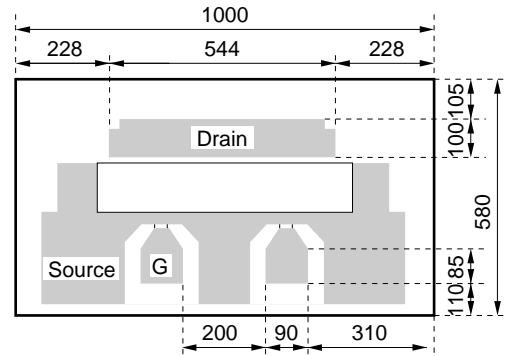

Remark Chip thickness: 140 μm
 G : Gate

RECOMMENDED SOLDERING CONDITIONS

This product should be soldered under the following recommended conditions. For soldering methods and conditions other than those recommended below, contact your NEC sales representative.

Soldering Method	Soldering Conditions	Recommended Condition Symbol
Partial Heating	Pin temperature: 260°C Time: 5 seconds or less (per pin row) Exposure limit: None ^{Note}	—

Note After opening the dry pack, keep it in a place below 25°C and 65 % RH for the allowable storage period.

Caution Do not use different soldering methods together (except for partial heating).

CHIP HANDLING

DIE ATTACHMENT

Die attach can be accomplished with a Au-Sn (300 ±10°C) performs in a forming gas environment. Epoxy die attach is not recommended.

BONDING

Gate and drain bonding wires should be minimum length, semi-hard gold wire (3 to 8 % elongation) 30 microns or less in diameter.

Bonding should be performed with a wedge tip that has a taper of approximately 15 %.

Die attach and bonding time should be kept to a minimum. As a general rule, the bonding operation should be kept within a 280°C_5 minute curve. If longer periods are required, the temperature should be lowered.

PRECAUTIONS

The user must operate in a clean, dry environment.

The chip channel is glassivated for mechanical protection only and does not preclude the necessity of a clean environment.

The bonding equipment should be periodically checked for sources of surge voltage and should be properly grounded at all times. In fact, all test and handling equipment should be grounded to minimize the possibilities of static discharge.

[MEMO]

[MEMO]

[MEMO]

Caution

The Great Care must be taken in dealing with the devices in this guide.

The reason is that the material of the devices is GaAs (Gallium Arsenide), which is designated as harmful substance according to the law concerned.

Keep the law concerned and so on, especially in case of removal.

- **The information in this document is subject to change without notice. Before using this document, please confirm that this is the latest version.**
 - No part of this document may be copied or reproduced in any form or by any means without the prior written consent of NEC Corporation. NEC Corporation assumes no responsibility for any errors which may appear in this document.
 - NEC Corporation does not assume any liability for infringement of patents, copyrights or other intellectual property rights of third parties by or arising from use of a device described herein or any other liability arising from use of such device. No license, either express, implied or otherwise, is granted under any patents, copyrights or other intellectual property rights of NEC Corporation or others.
 - Descriptions of circuits, software, and other related information in this document are provided for illustrative purposes in semiconductor product operation and application examples. The incorporation of these circuits, software, and information in the design of the customer's equipment shall be done under the full responsibility of the customer. NEC Corporation assumes no responsibility for any losses incurred by the customer or third parties arising from the use of these circuits, software, and information.
 - While NEC Corporation has been making continuous effort to enhance the reliability of its semiconductor devices, the possibility of defects cannot be eliminated entirely. To minimize risks of damage or injury to persons or property arising from a defect in an NEC semiconductor device, customers must incorporate sufficient safety measures in its design, such as redundancy, fire-containment, and anti-failure features.
 - NEC devices are classified into the following three quality grades:
"Standard", "Special", and "Specific". The Specific quality grade applies only to devices developed based on a customer designated "quality assurance program" for a specific application. The recommended applications of a device depend on its quality grade, as indicated below. Customers must check the quality grade of each device before using it in a particular application.
 - Standard: Computers, office equipment, communications equipment, test and measurement equipment, audio and visual equipment, home electronic appliances, machine tools, personal electronic equipment and industrial robots
 - Special: Transportation equipment (automobiles, trains, ships, etc.), traffic control systems, anti-disaster systems, anti-crime systems, safety equipment and medical equipment (not specifically designed for life support)
 - Specific: Aircraft, aerospace equipment, submersible repeaters, nuclear reactor control systems, life support systems or medical equipment for life support, etc.
- The quality grade of NEC devices is "Standard" unless otherwise specified in NEC's Data Sheets or Data Books. If customers intend to use NEC devices for applications other than those specified for Standard quality grade, they should contact an NEC sales representative in advance.