

This Hynix unbuffered Small Outline Dual In-Line Memory Module(DIMM) series consists of 2Gb version A DDR2 SDRAMs in Fine Ball Grid Array(FBGA) packages on a 200pin glass-epoxy substrate. This Hynix 2Gb version A based Unbuffered DDR2 SO-DIMM series provide a high performance 8 byte interface in 67.60mm width form factor of industry standard. It is suitable for easy interchange and addition.

FEATURES

- JEDEC standard Double Data Rate 2 Synchronous DRAMs (DDR2 SDRAMs) with 1.8V +/- 0.1V Power Supply
- All inputs and outputs are compatible with SSTL_1.8 interface
- Posted CAS
- Programmable CAS Latency 3 ,4 ,5, and 6
- OCD (Off-Chip Driver Impedance Adjustment) and ODT (On-Die Termination)
- Fully differential clock operations (CK & \overline{CK})
- Programmable Burst Length 4 / 8 with both sequential and interleave mode
- Auto refresh and self refresh supported
- 8192 refresh cycles / 64ms
- Serial presence detect with EEPROM
- DDR2 SDRAM Package: 63 ball(x4/x8)
- 67.60 x 30.00 mm form factor
- RoHS compliant

ORDERING INFORMATION

Part Name	Density	Organization	# of DRAMs	# of ranks	Materials
HMP451S6MMP8C- Y5/S6	4GB	512Mx64	16	2	Lead free

SPEED GRADE & KEY PARAMETERS

	Y5 (DDR2-667)	S6 (DDR2-800)	Unit
Speed@CL3	400	-	Mbps
Speed@CL4	533	533	Mbps
Speed@CL5	667	667	Mbps
Speed@CL6	-	800	Mbps
CL-tRCD-tRP	5-5-5	6-6-6	tCK

ADDRESS TABLE

Density	Organization	Ranks	SDRAMs	# of DRAMs	# of row/bank/column Address	Refresh Method
4GB	512M x 64	2	256Mb x 8	16	15(A0~A14)/3(BA0~BA2)/10(A0~A9)	8K / 64ms

PIN DESCRIPTION

Symbol	Type	Polarity	Pin Description
CK[1:0], \overline{CK} [1:0]	Input	Cross Point	The system clock inputs. All address and commands lines are sampled on the cross point of the rising edge of CK and falling edge of \overline{CK} . A Delay Locked Loop(DLL) circuit is driven from the clock inputs and output timing for read operations is synchronized to the input clock.
CKE[1:0]	Input	Active High	Activates the DDR2 SDRAM CK signal when high and deactivates the CK signal when low. By deactivating the clocks, CKE low initiates the Power Down mode or the Self Refresh mode.
\overline{S} [1:0]	Input	Active Low	Enables the associated DDR2 SDRAM command decoder when low and disables the command decoder when high. When the command decoder is disabled, new commands are ignored but previous operations continue. Rank 0 is selected by $\overline{S}0$; Rank 1 is selected by $\overline{S}1$
\overline{RAS} , \overline{CAS} , \overline{WE}	Input	Active Low	When sampled at the cross point of the rising edge of CK and falling edge of \overline{CK} , \overline{CAS} , \overline{RAS} and \overline{WE} define the operation to be executed by the SDRAM.
BA[2:0]	Input		Selects which DDR2 SDRAM internal bank of four or eight is activated.
ODT[1:0]	Input	Active High	Asserts on-die termination for DQ, DM, DQS and \overline{DQS} signals if enabled via the DDR2 SDRAM mode register.
A[9:0], A10/AP, A[15:11]	Input		During a Bank Activate command cycle, defines the row address when sampled at the cross point of the rising edge of CK and falling edge of \overline{CK} . During a Read or Write command cycle, defines the column address when sampled at the cross point of the rising edge of CK and falling edge of \overline{CK} . In addition to the column address, AP is used to invoke autoprecharge operation at the end of the burst read or write cycle. If AP is high, autoprecharge is selected and BA0-BAn defines the bank to be precharged. If AP is low, autoprecharge is disabled. During a Precharge command cycle, AP is used in conjunction with BA0-BAn to control which bank(s) to precharge. If AP is high, all banks will be precharged regardless of the state of BA0-BAn inputs. If AP is low, then BA0-BAn are used to define which bank to precharge.
DQ[63:0]	In/Out		Data Input/Output pins.
DM[7:0]	Input	Active High	The data write masks, associated with one data byte. In Write mode, DM operates as a byte mask by allowing input data to be written if it is low but blocks the write operation if it is high. In Read mode, DM lines have no effect.
DQS[7:0], \overline{DQS} [7:0]	In/Out	Cross point	The data strobe, associated with one data byte, sourced with data transfers. In Write mode, the data strobe is sourced by the controller and is centered in the data window. In Read mode, the data strobe is sourced by the DDR2 SDRAMs and is sent at leading edge of the data window. \overline{DQS} signals are complements, and timing is relative to the crosspoint of respective DQS and \overline{DQS} . If the module is to be operated in single ended strobe mode, all \overline{DQS} signals must be tied on the system board to VSS and DDR2 SDRAM mode registers programmed appropriately.
V _{DD} , V _{DD} SPD, V _{SS}	Supply		Power supplies for core, I/O, Serial Presence Detect, and ground for the module.
SDA	In/Out		This is a bidirectional pin used to transfer data into or out of the SPD EEPROM. A resistor must be connected to V _{DD} to act as a pull up.
SCL	Input		This signal is used to clock data into and out of the SPD EEPROM. A resistor may be connected from SCL to V _{DD} to act as a pull up.
SA[1:0]	Input		Address pins used to select the Serial Presence Detect base address.
TEST	In/Out		The TEST pin is reserved for bus analysis tools and is not connected on normal memory modules(SODIMMs).

PIN ASSIGNMENT

Pin NO.	Front Side	Pin NO.	Back Side	Pin NO.	Front Side	Pin NO.	Back Side	Pin NO.	Front Side	Pin NO.	Back Side	Pin NO.	Front Side	Pin NO.	Back Side
1	VREF	2	VSS	51	DQS2	52	DM2	101	A1	102	A0	151	DQ42	152	DQ46
3	VSS	4	DQ4	53	VSS	54	VSS	103	VDD	104	VDD	153	DQ43	154	DQ47
5	DQ0	6	DQ5	55	DQ18	56	DQ22	105	A10/AP	106	BA1	155	VSS	156	VSS
7	DQ1	8	VSS	57	DQ19	58	DQ23	107	BA0	108	RAS	157	DQ48	158	DQ52
9	VSS	10	DM0	59	VSS	60	VSS	109	WE	110	S0	159	DQ49	160	DQ53
11	DQS0	12	VSS	61	DQ24	62	DQ28	111	VDD	112	VDD	161	VSS	162	VSS
13	DQS0	14	DQ6	63	DQ25	64	DQ29	113	CAS	114	ODT0	163	NC,TEST	164	CK1
15	VSS	16	DQ7	65	VSS	66	VSS	115	NC/S1	116	A13	165	VSS	166	CK1
17	DQ2	18	VSS	67	DM3	68	DQS3	117	VDD	118	VDD	167	DQS6	168	VSS
19	DQ3	20	DQ12	69	NC	70	DQS3	119	NC/ODT1	120	NC	169	DQS6	170	DM6
21	VSS	22	DQ13	71	VSS	72	VSS	121	VSS	122	VSS	171	VSS	172	VSS
23	DQ8	24	VSS	73	DQ26	74	DQ30	123	DQ32	124	DQ36	173	DQ50	174	DQ54
25	DQ9	26	DM1	75	DQ27	76	DQ31	125	DQ33	126	DQ37	175	DQ51	176	DQ55
27	VSS	28	VSS	77	VSS	78	VSS	127	VSS	128	VSS	177	VSS	178	VSS
29	DQS1	30	CK0	79	CKE0	80	NC/CKE1	129	DQS4	130	DM4	179	DQ56	180	DQ60
31	DQS1	32	CK0	81	VDD	82	VDD	131	DQS4	132	VSS	181	DQ57	182	DQ61
33	VSS	34	VSS	83	NC	84	NC/A15	133	VSS	134	DQ38	183	VSS	184	VSS
35	DQ10	36	DQ14	85	BA2	86	NC/A14	135	DQ34	136	DQ39	185	DM7	186	DQS7
37	DQ11	38	DQ15	87	VDD	88	VDD	137	DQ35	138	VSS	187	VSS	188	DQS7
39	VSS	40	VSS	89	A12	90	A11	139	VSS	140	DQ44	189	DQ58	190	VSS
41	VSS	42	VSS	91	A9	92	A7	141	DQ40	142	DQ45	191	DQ59	192	DQ62
43	DQ16	44	DQ20	93	A8	94	A6	143	DQ41	144	VSS	193	VSS	194	DQ63
45	DQ17	46	DQ21	95	VDD	96	VDD	145	VSS	146	DQS5	195	SDA	196	VSS
47	VSS	48	VSS	97	A5	98	A4	147	DM5	148	DQS5	197	SCL	198	SA0
49	DQS2	50	NC	99	A3	100	A2	149	VSS	150	VSS	199	VDDSPD	200	SA1

Pin Location

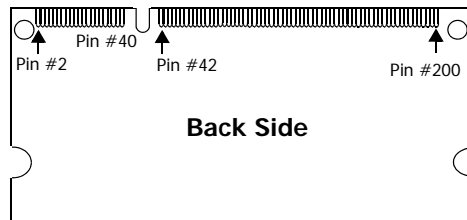
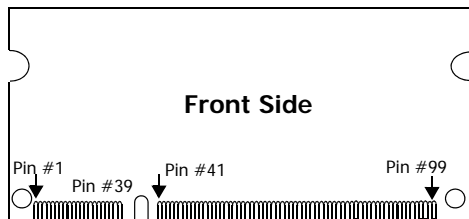

FUNCTIONAL BLOCK DIAGRAM

4GB(512Mb \times 64) : HMP451S6MMP8C

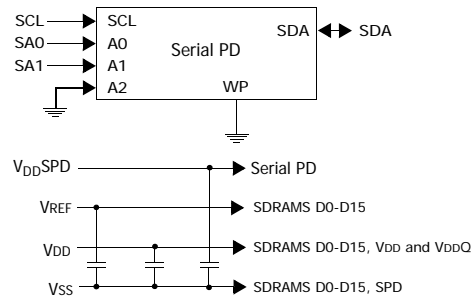
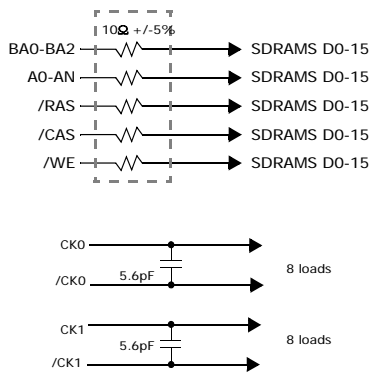
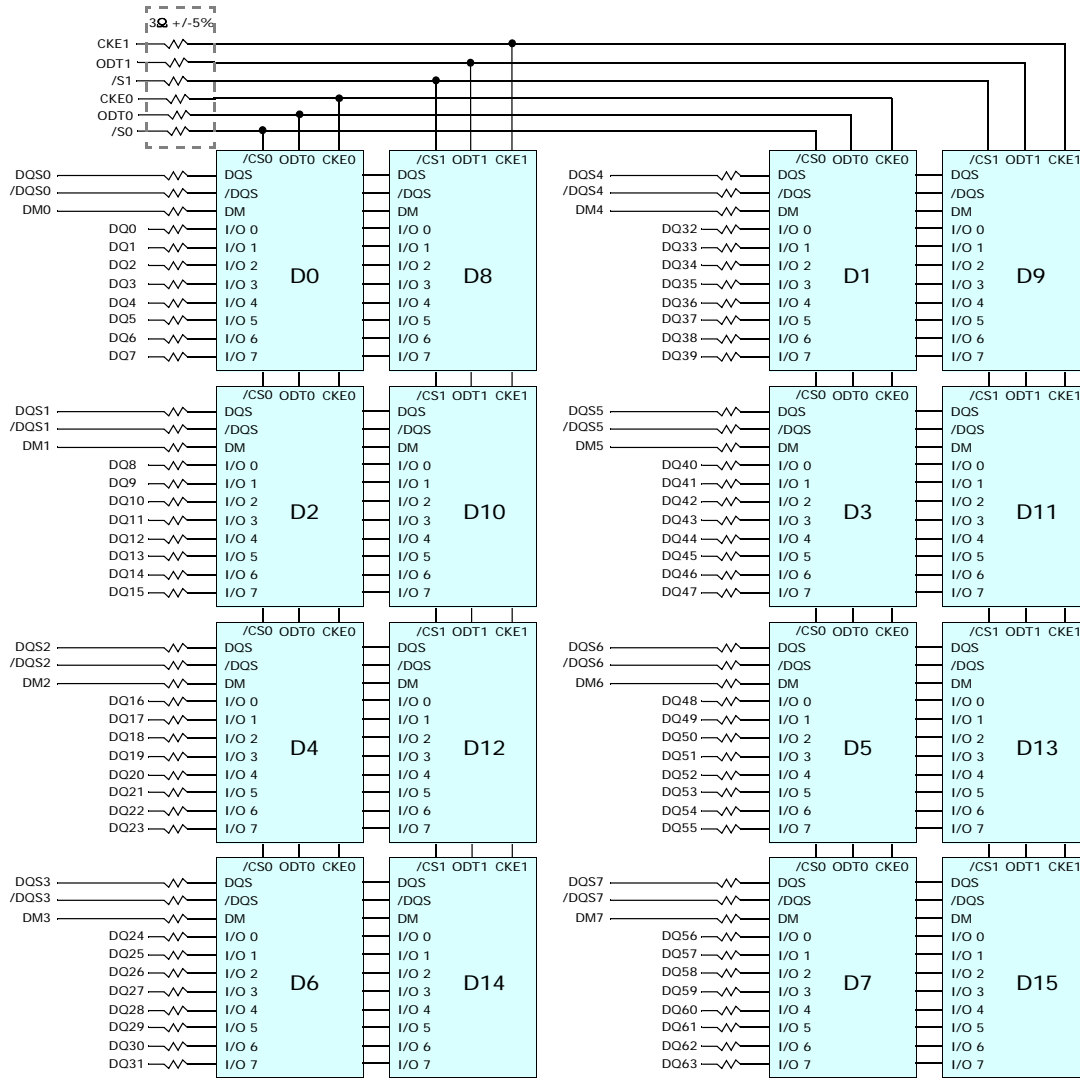

Note:
1. Resistor values are 22 ohm +/-5% unless otherwise stated.

ABSOLUTE MAXIMUM RATINGS

Parameter	Symbol	Value	Unit	Note
Voltage on V _{DD} pin relative to V _{ss}	V _{DD}	- 1.0 V ~ 2.3 V	V	1
Voltage on V _{DDQ} pin relative to V _{ss}	V _{DDQ}	- 0.5 V ~ 2.3 V	V	1
Voltage on VDDL pin relative to V _{ss}	VDDL	-0.5V ~ 2.3 V	V	1
Voltage on any pin relative to V _{ss}	V _{IN} , V _{OUT}	- 0.5 V ~ 2.3 V	V	1

Operating Conditions and Environmental Parameters

Parameter	Symbol	Rating	Units	Notes
DIMM Operating temperature(ambient)	T _{OPR}	0 ~ +65	°C	
Storage Temperature	T _{STG}	-50 ~ +100	°C	1
Storage Humidity(without condensation)	H _{STG}	5 to 95	%	1
DIMM Barometric Pressure(operating & storage)	p _{BAR}	105 to 69	K Pascal	2
DRAM Component Case Temperature Range	T _{CASE}	0 ~ +95	°C	3

Notes:

1. Stress greater than those listed may cause permanent damage to the device. This is a stress rating only, and device functional operation at or above the conditions indicated is not implied. Exposure to absolute maximum rating conditions for extended periods may affect reliability.
2. Up to 9850 ft.
3. If the DRAM case temperature is Above 85oC, the Auto-Refresh command interval has to be reduced to tREFI=3.9us. For Measurement conditions of TCASE, please refer to the JEDEC document JESD51-2.

DC OPERATING CONDITIONS (SSTL_1.8)

Symbol	Parameter	Rating			Units	Notes
		Min.	Typ.	Max.		
VDD	Supply Voltage	1.7	1.8	1.9	V	1
VDDL	Supply Voltage for DLL	1.7	1.8	1.9	V	1,2
VDDQ	Supply Voltage for Output	1.7	1.8	1.9	V	1,2
VREF	Input Reference Voltage	0.49*VDDQ	0.50*VDDQ	0.51*VDDQ	mV	3,4
VTT	Termination Voltage	VREF-0.04	VREF	VREF+0.04	V	5
VDDSPD	EEPROM Supply Voltage	1.8	-	3.3	V	

Note:

1. Min. Typ. and Max. values increase by 100mV for C3(DDR2-533 3-3-3) speed option.
2. VDDQ tracks with VDD,VDDL tracks with VDD. AC parameters are measured with VDD,VDDQ and VDD.
3. The value of VREF may be selected by the user to provide optimum noise margin in the system. Typically the value of VREF is expected to be about 0.5 x VDDQ of the transmitting device and VREF is expected to track variations in VDDQ.
4. Peak to peak ac noise on VREF may not exceed +/-2% VREF (dc).
5. VTT of transmitting device must track VREF of receiving device.

INPUT DC LOGIC LEVEL

Parameter	Symbol	Min	Max	Unit	Note
dc Input logic HIGH	$V_{IH}(DC)$	$V_{REF} + 0.125$	$V_{DDQ} + 0.3$	V	
dc Input logic LOW	$V_{IL}(DC)$	-0.30	$V_{REF} - 0.125$	V	

INPUT AC LOGIC LEVEL

Parameter	Symbol	DDR2 667		DDR2 800		Unit
		Min	Max	Min	Max	
AC Input logic HIGH	$V_{IH}(AC)$	$V_{REF} + 0.200$	-	$V_{REF} + 0.200$	-	V
AC Input logic LOW	$V_{IL}(AC)$	-	$V_{REF} - 0.200$	-	$V_{REF} - 0.200$	V

AC INPUT TEST CONDITIONS

Symbol	Condition	Value	Units	Notes
V_{REF}	Input reference voltage	$0.5 * V_{DDQ}$	V	1
$V_{SWING}(MAX)$	Input signal maximum peak to peak swing	1.0	V	1
SLEW	Input signal minimum slew rate	1.0	V/ns	2, 3

Notes:

1. Input waveform timing is referenced to the input signal crossing through the V_{REF} level applied to the device under test.
2. The input signal minimum slew rate is to be maintained over the range from V_{REF} to $V_{IH(ac) \min}$ for rising edges and the range from V_{REF} to $V_{IL(ac) \max}$ for falling edges as shown in the below figure.
3. AC timings are referenced with input waveforms switching from $V_{IL(ac)}$ to $V_{IH(ac)}$ on the positive transitions and $V_{IH(ac)}$ to $V_{IL(ac)}$ on the negative transitions.

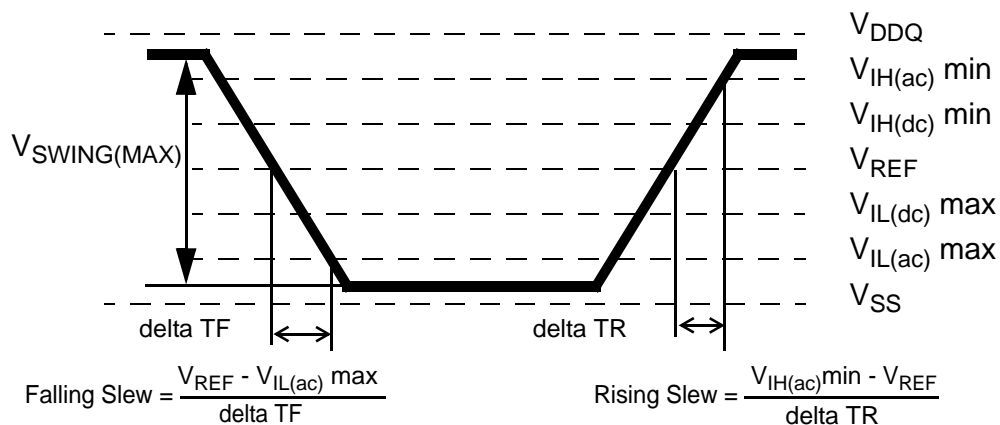

< Figure : AC Input Test Signal Waveform >

Differential Input AC logic Level

Symbol	Parameter	Min.	Max.	Units	Note
V_{ID} (ac)	ac differential input voltage	0.5	$V_{DDQ} + 0.6$	V	1
V_{IX} (ac)	ac differential cross point voltage	$0.5 * V_{DDQ} - 0.175$	$0.5 * V_{DDQ} + 0.175$	V	2

- $V_{IN}(DC)$ specifies the allowable DC execution of each input of differential pair such as \overline{CK} , \overline{DQS} , \overline{LDQS} , \overline{UDQS} , \overline{LDQS} , \overline{UDQS} and \overline{UDQS} .
- $V_{ID}(DC)$ specifies the input differential voltage $|V_{TR} - V_{CP}|$ required for switching, where V_{TR} is the true input (such as \overline{CK} , \overline{DQS} , \overline{LDQS} or \overline{UDQS}) level and V_{CP} is the complementary input (such as \overline{CK} , \overline{DQS} , \overline{LDQS} or \overline{UDQS}) level. The minimum value is equal to $V_{IH}(DC) - V_{IL}(DC)$.

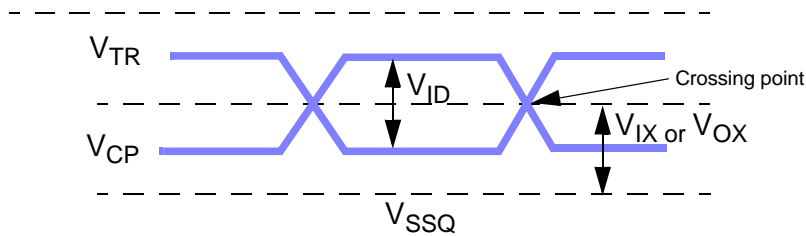

< Differential signal levels >

Notes:

- $V_{ID}(AC)$ specifies the input differential voltage $|V_{TR} - V_{CP}|$ required for switching, where V_{TR} is the true input signal (such as \overline{CK} , \overline{DQS} , \overline{LDQS} or \overline{UDQS}) and V_{CP} is the complementary input signal (such as \overline{CK} , \overline{DQS} , \overline{LDQS} or \overline{UDQS}). The minimum value is equal to $V_{IH}(AC) - V_{IL}(AC)$.
- The typical value of $V_{IX}(AC)$ is expected to be about $0.5 * V_{DDQ}$ of the transmitting device and $V_{IX}(AC)$ is expected to track variations in V_{DDQ} . $V_{IX}(AC)$ indicates the voltage at which differential input signals must cross.

DIFFERENTIAL AC OUTPUT PARAMETERS

Symbol	Parameter	Min.	Max.	Units	Note
V_{OX} (ac)	ac differential cross point voltage	$0.5 * V_{DDQ} - 0.125$	$0.5 * V_{DDQ} + 0.125$	V	1

Notes:

- The typical value of $V_{OX}(AC)$ is expected to be about $0.5 * V_{DDQ}$ of the transmitting device and $V_{OX}(AC)$ is expected to track variations in V_{DDQ} . $V_{OX}(AC)$ indicates the voltage at which differential output signals must cross.

OUTPUT BUFFER LEVELS

OUTPUT AC TEST CONDITIONS

Symbol	Parameter	SSTL_18	Units	Notes
V_{OTR}	Output Timing Measurement Reference Level	$0.5 * V_{DDQ}$	V	1

Notes:

1. The VDDQ of the device under test is referenced.

OUTPUT DC CURRENT DRIVE

Symbol	Parameter	SSTL_18	Units	Notes
$I_{OH(dc)}$	Output Minimum Source DC Current	- 13.4	mA	1, 3, 4
$I_{OL(dc)}$	Output Minimum Sink DC Current	13.4	mA	2, 3, 4

Notes:

1. $V_{DDQ} = 1.7$ V; $V_{OUT} = 1420$ mV. $(V_{OUT} - V_{DDQ})/I_{OH}$ must be less than 21 ohm for values of V_{OUT} between V_{DDQ} and $V_{DDQ} - 280$ mV.
2. $V_{DDQ} = 1.7$ V; $V_{OUT} = 280$ mV. V_{OUT}/I_{OL} must be less than 21 ohm for values of V_{OUT} between 0 V and 280 mV.
3. The dc value of V_{REF} applied to the receiving device is set to V_{TT}
4. The values of $I_{OH(dc)}$ and $I_{OL(dc)}$ are based on the conditions given in Notes 1 and 2. They are used to test device drive current capability to ensure V_{IH} min plus a noise margin and V_{IL} max minus a noise margin are delivered to an SSTL_18 receiver.
The actual current values are derived by shifting the desired driver operating point along a 21 ohm load line to define a convenient driver current for measurement.

PIN Capacitance (VDD=1.8V,VDDQ=1.8V, TA=25°...)

4GB : HMP451S6MMP8C

Pin	Symbol	Min	Max	Unit
CK, $\overline{\text{CK}}$	CCK	20	37	pF
CKE, ODT,CS	CI1	25	49	pF
Address, $\overline{\text{RAS}}$, $\overline{\text{CAS}}$, $\overline{\text{WE}}$	CI2	32	61	pF
DQ, DM, DQS, $\overline{\text{DQS}}$	CIO	8	13	pF

Notes:

1. Pins not under test are tied to GND.
2. These value are guaranteed by design and tested on a sample basis only.

IDD SPECIFICATIONS (T_{CASE} : 0 to 95°C)

4GB, 512M x 64 SO-DIMM : HMP451S6MMP8C

Symbol	Y5 (DDR2 667@CL5)	S5/S6 (DDR2 800@CL5&6)	Unit	Note
IDD0	2080	2080	mA	
IDD1	2400	2400	mA	
IDD2P	128	240	mA	
IDD2Q	720	720	mA	
IDD2N	800	800	mA	
IDD3P(F)	560	560	mA	
IDD3P(S)	288	288	mA	
IDD3N	880	880	mA	
IDD4R	3520	3520	mA	
IDD4W	3200	3200	mA	
IDD5B	4480	4480	mA	
IDD6	128	240	mA	1
IDD6(L)	80	128	mA	1
IDD7	5520	5520	mA	

Notes:

1. IDD6 current values are guaranteed up to Tcase of 85c max.

IDD Measurement Conditions

Symbol	Conditions	Units
IDD0	Operating one bank active-precharge current ; $t_{CK} = t_{CK}(IDD)$, $t_{RC} = t_{RC}(IDD)$, $t_{RAS} = t_{RASmin}(IDD)$; CKE is HIGH, \overline{CS} is HIGH between valid commands; Address bus inputs are SWITCHING; Data bus inputs are SWITCHING	mA
IDD1	Operating one bank active-read-precharge current ; $I_{OUT} = 0mA$; $BL = 4$, $CL = CL(ADD)$, $AL = 0$; $t_{CK} = t_{CK}(IDD)$, $t_{RC} = t_{RC}(ADD)$, $t_{RAS} = t_{RASmin}(IDD)$, $t_{RCD} = t_{RCD}(IDD)$; CKE is HIGH, \overline{CS} is HIGH between valid commands; Address bus inputs are SWITCHING; Data pattern is same as IDD4W	mA
IDD2P	Precharge power-down current ; All banks idle; $t_{CK} = t_{CK}(IDD)$; CKE is LOW; Other control and address bus inputs are STABLE; Data bus inputs are FLOATING	mA
IDD2Q	Precharge quiet standby current ; All banks idle; $t_{CK} = t_{CK}(IDD)$; CKE is HIGH, \overline{CS} is HIGH; Other control and address bus inputs are STABLE; Data bus inputs are FLOATING	mA
IDD2N	Precharge standby current ; All banks idle; $t_{CK} = t_{CK}(IDD)$; CKE is HIGH, \overline{CS} is HIGH; Other control and address bus inputs are SWITCHING; Data bus inputs are SWITCHING	mA
IDD3P	Active power-down current ; All banks open; $t_{CK} = t_{CK}(IDD)$; CKE is LOW; Other control and address bus inputs are STABLE; Data bus inputs are FLOATING	Fast PDN Exit MRS(12) = 0
		Slow PDN Exit MRS(12) = 1
IDD3N	Active standby current ; All banks open; $t_{CK} = t_{CK}(IDD)$, $t_{RAS} = t_{RASmax}(IDD)$, $t_{RP} = t_{RP}(IDD)$; CKE is HIGH, \overline{CS} is HIGH between valid commands; Other control and address bus inputs are SWITCHING; Data bus inputs are SWITCHING	mA
IDD4W	Operating burst write current ; All banks open, Continuous burst writes; $BL = 4$, $CL = CL(ADD)$, $AL = 0$; $t_{CK} = t_{CK}(IDD)$, $t_{RAS} = t_{RASmax}(IDD)$, $t_{RP} = t_{RP}(IDD)$; CKE is HIGH, \overline{CS} is HIGH between valid commands; Address bus inputs are SWITCHING; Data bus inputs are SWITCHING	mA
IDD4R	Operating burst read current ; All banks open, Continuous burst reads, $I_{OUT} = 0mA$; $BL = 4$, $CL = CL(ADD)$, $AL = 0$; $t_{CK} = t_{CK}(IDD)$, $t_{RAS} = t_{RASmax}(IDD)$, $t_{RP} = t_{RP}(IDD)$; CKE is HIGH, \overline{CS} is HIGH between valid commands; Address bus inputs are SWITCHING; Data pattern is same as IDD4W	mA
IDD5B	Burst refresh current ; $t_{CK} = t_{CK}(IDD)$; Refresh command at every $t_{RFC}(IDD)$ interval; CKE is HIGH, \overline{CS} is HIGH between valid commands; Other control and address bus inputs are SWITCHING; Data bus inputs are SWITCHING	mA
IDD6	Self refresh current ; CK and \overline{CK} at 0V; $CKE \leq 0.2V$; Other control and address bus inputs are FLOATING; Data bus inputs are FLOATING. IDD6 current values are guaranteed up to Tcase of 85 °C max.	mA
IDD7	Operating bank interleave read current ; All bank interleaving reads, $I_{OUT} = 0mA$; $BL = 4$, $CL = CL(ADD)$, $AL = t_{RCD}(IDD) - 1 * t_{CK}(IDD)$; $t_{CK} = t_{CK}(IDD)$, $t_{RC} = t_{RC}(ADD)$, $t_{RRD} = t_{RRD}(IDD)$, $t_{RCD} = 1 * t_{CK}(IDD)$; CKE is HIGH, \overline{CS} is HIGH between valid commands; Address bus inputs are STABLE during DESELECTs; Data pattern is same as IDD4R; - Refer to the following page for detailed timing conditions	mA

Notes:

1. IDD specifications are tested after the device is properly initialized
2. Input slew rate is specified by AC Parametric Test Condition
3. IDD parameters are specified with ODT disabled.
4. Data bus consists of DQ, DM, DQS, \overline{DQS} , RDQS, \overline{RDQS} , LDQS, \overline{LDQS} , UDQS, and \overline{UDQS} . IDD values must be met with all combinations of EMRS bits 10 and 11.
5. Definitions for IDD
 - LOW is defined as $V_{in} \leq V_{ILAC}(max)$
 - HIGH is defined as $V_{in} \geq V_{IHAC}(min)$
 - STABLE is defined as inputs stable at a HIGH or LOW level
 - FLOATING is defined as inputs at $V_{REF} = V_{DDQ}/2$
 - SWITCHING is defined as: inputs changing between HIGH and LOW every other clock cycle (once per two clocks) for address and control signals, and inputs changing between HIGH and LOW every other data transfer (once per clock) for DQ signals not including masks or strobes.

Electrical Characteristics & AC Timings
Speed Bins and CL,tRCD,tRP,tRC and tRAS for Corresponding Bin

Speed	DDR2-800 (S5)	DDR2-800 (S6)	DDR2-667 (Y5)	Unit
Bin(CL-tRCD-tRP)	5-5-5	6-6-6	5-5-5	
Parameter	min	min	min	
CAS Latency	5	6	5	tCK
tRCD	12.5	15	15	ns
tRP	12.5	15	15	ns
tRAS	45	45	45	ns
tRC	57.5	60	60	ns

AC Timing Parameters by Speed Grade

Parameter	Symbol	DDR2-667		DDR2-800		Unit	Note
		min	max	min	max		
Average clock period	tCK	3000	8000	2500	8000	ps	35,36
Average clock HIGH pulse width	tCH	0.48	0.52	0.48	0.52	tCK	35,36
Average clock LOW pulse width	tCL	0.48	0.52	0.48	0.52	tCK	35,36
Write command to DQS associated clock edge	WL	RL-1	RL-1	RL-1	RL-1	nCK	
DQS latching rising transition to associated clock edges	tDQSS	-0.25	0.25	-0.25	0.25	tCK	30
DQS falling edge to CK setup time	tDSS	0.2	X	0.2	X	tCK	30
DQS falling edge hold time from CK	tDSH	0.2	X	0.2	X	tCK	30
DQS input HIGH pulse width	tDQSH	0.35	X	0.35	X	tCK	
DQS input LOW pulse width	tDQSL	0.35	X	0.35	X	tCK	
Write preamble	tWPRE	0.35	X	0.35	X	tCK	
Write postamble	tWPST	0.4	0.6	0.4	0.6	tCK	10
Address and control input setup time	tIS	200	X	175	X	ps	5,7,9,22,29
Address and control input hold time	tIH	275	X	250	X	ps	5,7,9,22,29
Control & Address input pulse width for each input	tIPW	0.6	X	0.6	X	tCK	
DQ and DM input setup time	tDS	100	X	50	X	ps	6,7,8,20,28,31
DQ and DM input hold time	tDH	175	X	125	X	ps	6,7,8,20,28,31
DQ and DM input pulse width for each input	tDIPW	0.35	X	0.35	X	tCK	

Parameter	Symbol	DDR2-667		DDR2-800		Unit	Note
		min	max	min	max		
DQ output access time from CK/ $\overline{\text{CK}}$	tAC	-450	+450	-400	+400	ps	
DQS output access time from CK/ $\overline{\text{CK}}$	tDQSCK	-400	+400	-350	+350	ps	
CK high-level width	tCH	0.45	0.55	0.48	0.52	tCK	
CK low-level width	tCL	0.45	0.55	0.48	0.52	tCK	
CK half period	tHP	min(tCL, tCH)	-	min(tCL, tCH)	-	ps	
Clock cycle time, CL=x	tCK	3000	8000	2500	8000	ps	
DQ and DM input setup time (differential strobe)	tDS	100	-	50	-	ps	1
DQ and DM input hold time (differential strobe)	tDH	175	-	125	-	ps	1
Control & Address input pulse width for each input	tIPW	0.6	-	0.6	-	tCK	
DQ and DM input pulse width for each input	tDIPW	0.35	-	0.35	-	tCK	
Data-out high-impedance time from CK/ $\overline{\text{CK}}$	tHZ	-	tAC max	-	tAC max	ps	
DQS low-impedance time from CK/ $\overline{\text{CK}}$	tLZ(DQS)	tAC min	tAC max	tAC min	tAC max	ps	
DQ low-impedance time from CK/ $\overline{\text{CK}}$	tLZ(DQ)	2*tAC min	tAC max	2*tAC min	tAC max	ps	
DQS-DQ skew for DQS and associated DQ signals	tDQSQ	-	240	-	240	ps	
DQ hold skew factor	tQHS	-	340	-	300	ps	
DQ/DQS output hold time from DQS	tQH	tHP - tQHS	-	tHP - tQHS	-	ps	
First DQS latching transition to associated clock edge	tDQSS	-0.25	+0.25	-0.25	+0.25	tCK	
DQS input high pulse width	tDQSH	0.35	-	0.35	-	tCK	
DQS input low pulse width	tDQSL	0.35	-	0.35	-	tCK	
DQS falling edge to CK setup time	tDSS	0.2	-	0.2	-	tCK	
DQS falling edge hold time from CK	tDSH	0.2	-	0.2	-	tCK	
Mode register set command cycle time	tMRD	2	-	2	-	tCK	
Write preamble	tWPRE	0.35	-	0.35	-	tCK	
Write postamble	tWPST	0.4	0.6	0.4	0.6	tCK	
Address and control input setup time	tIS	200	-	175	-	ps	
Address and control input hold time	tIH	275	-	250	-	ps	
Read preamble	tRPRE	0.9	1.1	0.9	1.1	tCK	
Read postamble	tRPST	0.4	0.6	0.4	0.6	tCK	
Activate to precharge command	tRAS	45	70000	45	70000	ns	
Row Active to Row Active Delay for 1KB page size	tRRD	7.5	-	7.5	-	ns	
Row Active to Row Active Delay for 2KB page size	tRRD	10	-	10	-	ns	
Four Active Window for 1KB page size products	tFAW	37.5	-	35	-	ns	

- continued -

Parameter	Symbol	DDR2-667		DDR2-800		Unit	Note
		min	max	min	max		
CAS to $\overline{\text{CAS}}$ command delay	tCCD	2	-	2	-	tCK	
Write recovery time	tWR	15	-	15	-	ns	
Auto precharge write recovery + precharge time	tDAL	WR+tRP	-	WR+tRP	-	tCK	
Internal write to read command delay	tWTR	7.5	-	7.5	-	ns	
Internal read to precharge command delay	tRTP	7.5	-	7.5	-	ns	
Exit self refresh to a non-read command	tXSNR	tRFC + 10	-	tRFC + 10	-	ns	
Exit self refresh to a read command	tXSRD	200	-	200	-	tCK	
Exit precharge power down to any non-read command	tXP	2	-	2	-	tCK	
Exit active power down to read command	tXARD	2	-	2	-	tCK	
Exit active power down to read command (Slow exit, Lower power)	tXARDS	7 - AL	-	8 - AL	-	tCK	
CKE minimum pulse width (high and low pulse width)	tCKE	3	-	3	-	tCK	
ODT turn-on delay	tAOND	2	2	2	2	tCK	
ODT turn-on	tAON	tAC(min)	tAC(max)+0.7	tAC(min)	tAC(max)+0.7	ns	
ODT turn-on(Power-Down mode)	tAONPD	tAC(min)+2	2tCK+tAC(max)+1	tAC(min)+2	2tCK+tAC(max)+1	ns	
ODT turn-off delay	tAOFD	2.5	2.5	2.5	2.5	tCK	
ODT turn-off	tAOF	tAC(min)	tAC(max)+ 0.6	tAC(min)	tAC(max)+ 0.6	ns	
ODT turn-off (Power-Down mode)	tAOFPD	tAC(min)+2	2.5tCK+tAC(max)+1	tAC(min)+2	2.5tCK+tAC(max)+1	ns	
ODT to power down entry latency	tANPD	3	-	3	-	tCK	
ODT power down exit latency	tAXPD	8	-	8	-	tCK	
OCD drive mode output delay	tOIT	0	12	0	12	ns	
Minimum time clocks remains ON after CKE asynchronously drops LOW	tDelay	tIS+tCK+tIH	-	tIS+tCK+tIH	-	ns	
Average periodic Refresh Interval	tREFI	-	7.8	-	7.8	us	2
	tREFI	-	3.9	-	3.9	us	3

Notes:

1. For details and notes, please refer to the relevant Hynix component datasheet(H5PS4G83MMP).
2. $0^{\circ}\text{C} \leq T_{\text{CASE}} \leq 85^{\circ}\text{C}$
3. $85^{\circ}\text{C} < T_{\text{CASE}} \leq 95^{\circ}\text{C}$

PACKAGE OUTLINE

512Mx64 - HYMP451S6MMP8

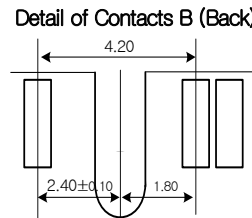
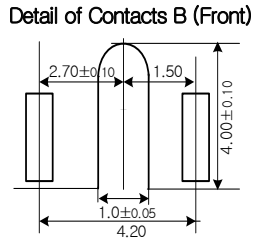
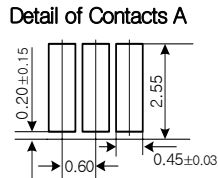
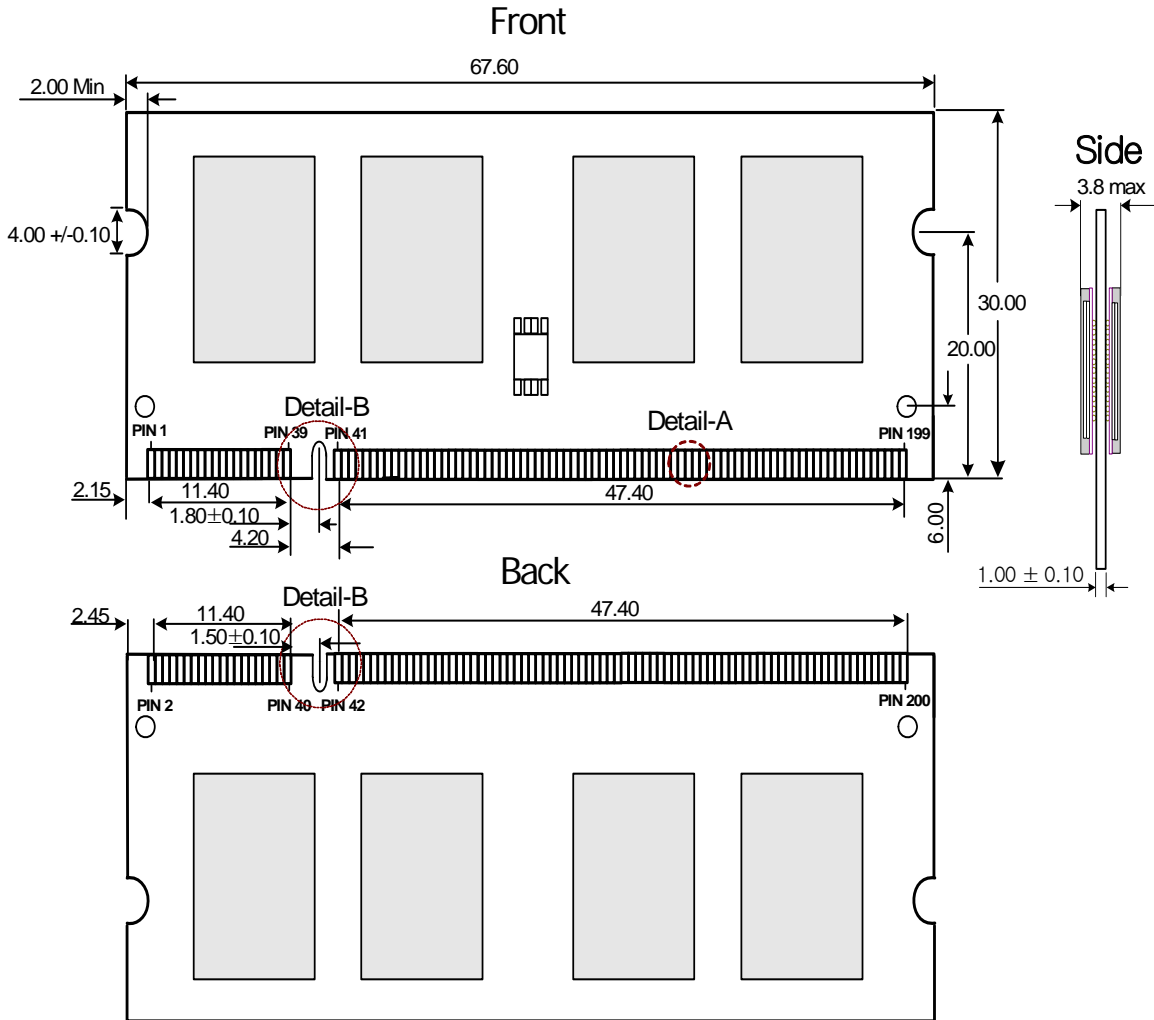

Note:

1. All dimensions are in millimeters.
2. All outline dimensions and tolerances follow the JEDEC standard.

REVISION HISTORY

Revision	History	Date
0.1	Initial data sheet released	May. 2008