

NTP75N06, NTB75N06

Power MOSFET 75 Amps, 60 Volts N-Channel TO-220 and D²PAK

Designed for low voltage, high speed switching applications in power supplies, converters and power motor controls and bridge circuits.

Typical Applications

- Power Supplies
- Converters
- Power Motor Controls
- Bridge Circuits

MAXIMUM RATINGS (T_J = 25°C unless otherwise noted)

Rating	Symbol	Value	Unit
Drain-to-Source Voltage	V _{DSS}	60	Vdc
Drain-to-Gate Voltage (R _{GS} = 10 MΩ)	V _{DGR}	60	Vdc
Gate-to-Source Voltage	V _{GS}	±20	Vdc
- Continuous	V _{GS}	±30	
- Non-Repetitive (t _p ≤ 10 ms)			
Drain Current	I _D	75	A dc
- Continuous @ T _A = 25°C	I _D	50	
- Continuous @ T _A = 100°C	I _{DM}	225	A pk
- Single Pulse (t _p ≤ 10 μs)			
Total Power Dissipation @ T _A = 25°C	P _D	214	W
Derate above 25°C		1.4	W/°C
Total Power Dissipation @ T _A = 25°C		2.4	W
Operating and Storage Temperature Range	T _J , T _{stg}	-55 to +175	°C
Single Pulse Drain-to-Source Avalanche Energy - Starting T _J = 25°C (V _{DD} = 50 Vdc, V _{GS} = 10 Vdc, L = 0.3 mH I _{L(pk)} = 75 A, V _{DS} = 60 Vdc)	E _{AS}	844	mJ
Thermal Resistance	R _{θJC} R _{θJA}	0.7 62.5	°C/W
- Junction-to-Case			
- Junction-to-Ambient			
Maximum Lead Temperature for Soldering Purposes, 1/8" from case for 10 seconds	T _L	260	°C



ON Semiconductor®

<http://onsemi.com>

**75 AMPERES
60 VOLTS**

R_{DS(on)} = 9.5 mΩ

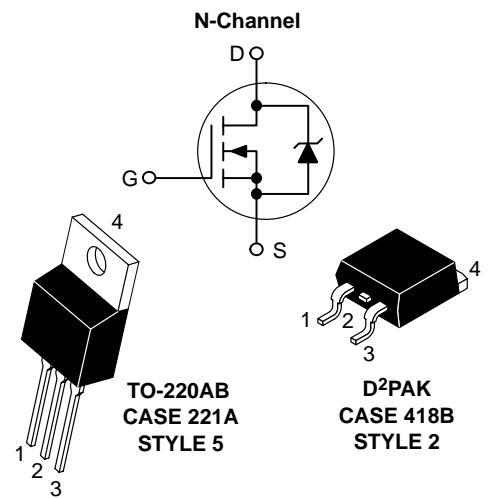

MARKING DIAGRAMS & PIN ASSIGNMENTS

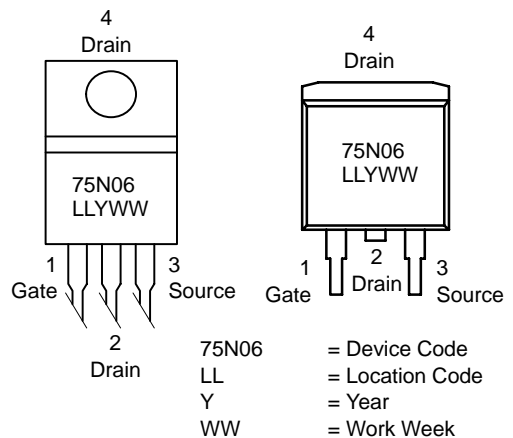

ORDERING INFORMATION

Device	Package	Shipping
NTP75N06	TO-220AB	50 Units/Rail
NTB75N06	D ² PAK	50 Units/Rail
NTB75N06T4	D ² PAK	800/Tape & Reel

NTP75N06, NTB75N06

ELECTRICAL CHARACTERISTICS (T_J = 25°C unless otherwise noted)

Characteristic	Symbol	Min	Typ	Max	Unit
OFF CHARACTERISTICS					
Drain-to-Source Breakdown Voltage (Note 1) (V _{GS} = 0 Vdc, I _D = 250 μAdc) Temperature Coefficient (Positive)	V _{(BR)DSS}	60 -	71 73	- -	Vdc mV/°C
Zero Gate Voltage Drain Current (V _{DS} = 60 Vdc, V _{GS} = 0 Vdc) (V _{DS} = 60 Vdc, V _{GS} = 0 Vdc, T _J = 150°C)	I _{DSS}	- -	- -	10 100	μAdc
Gate-Body Leakage Current (V _{GS} = ±20 Vdc, V _{DS} = 0 Vdc)	I _{GSS}	-	-	±100	nAdc

ON CHARACTERISTICS (Note 1)

Gate Threshold Voltage (Note 1) (V _{DS} = V _{GS} , I _D = 250 μAdc) Threshold Temperature Coefficient (Negative)	V _{GS(th)}	2.0 -	2.8 8.0	4.0 -	Vdc mV/°C
Static Drain-to-Source On-Resistance (Note 1) (V _{GS} = 10 Vdc, I _D = 37.5 Adc)	R _{DS(on)}	-	8.2	9.5	mOhm
Static Drain-to-Source On-Voltage (Note 1) (V _{GS} = 10 Vdc, I _D = 75 Adc) (V _{GS} = 10 Vdc, I _D = 37.5 Adc, T _J = 150°C)	V _{DS(on)}	- -	0.72 0.63	0.86 -	Vdc
Forward Transconductance (Note 1) (V _{DS} = 15 Vdc, I _D = 37.5 Adc)	g _{FS}	-	40.2	-	mhos

DYNAMIC CHARACTERISTICS

Input Capacitance	(V _{DS} = 25 Vdc, V _{GS} = 0 Vdc, f = 1.0 MHz)	C _{iss}	-	3220	4510	pF
Output Capacitance		C _{oss}	-	1020	1430	
Transfer Capacitance		C _{rss}	-	234	330	

SWITCHING CHARACTERISTICS (Note 2)

Turn-On Delay Time	(V _{DD} = 30 Vdc, I _D = 75 Adc, V _{GS} = 10 Vdc, R _G = 9.1 Ω) (Note 1)	t _{d(on)}	-	16	25	ns
Rise Time		t _r	-	112	155	
Turn-Off Delay Time		t _{d(off)}	-	90	125	
Fall Time		t _f	-	100	140	
Gate Charge	(V _{DS} = 48 Vdc, I _D = 75 Adc, V _{GS} = 10 Vdc) (Note 1)	Q _T	-	92	130	nC
		Q ₁	-	14	-	
		Q ₂	-	44	-	

SOURCE-DRAIN DIODE CHARACTERISTICS

Forward On-Voltage	(I _S = 75 Adc, V _{GS} = 0 Vdc) (Note 1) (I _S = 75 Adc, V _{GS} = 0 Vdc, T _J = 150°C)	V _{SD}	- -	1.0 0.9	1.1 -	Vdc
Reverse Recovery Time	(I _S = 75 Adc, V _{GS} = 0 Vdc, di _S /dt = 100 A/μs) (Note 1)	t _{rr}	-	77	-	ns
		t _a	-	49	-	
		t _b	-	28	-	
Reverse Recovery Stored Charge		Q _{RR}	-	0.16	-	μC

1. Pulse Test: Pulse Width ≤ 300 μs, Duty Cycle ≤ 2%.
2. Switching characteristics are independent of operating junction temperatures.

NTP75N06, NTB75N06

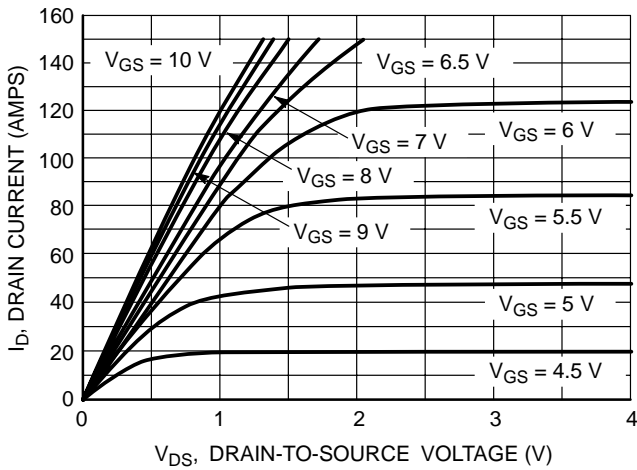

Figure 1. On-Region Characteristics

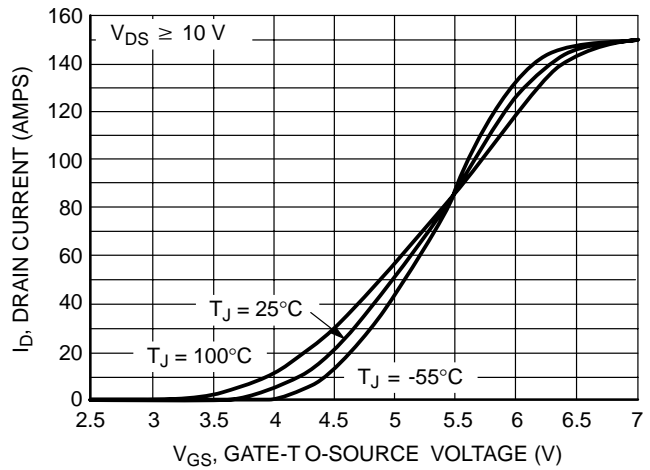

Figure 2. Transfer Characteristics

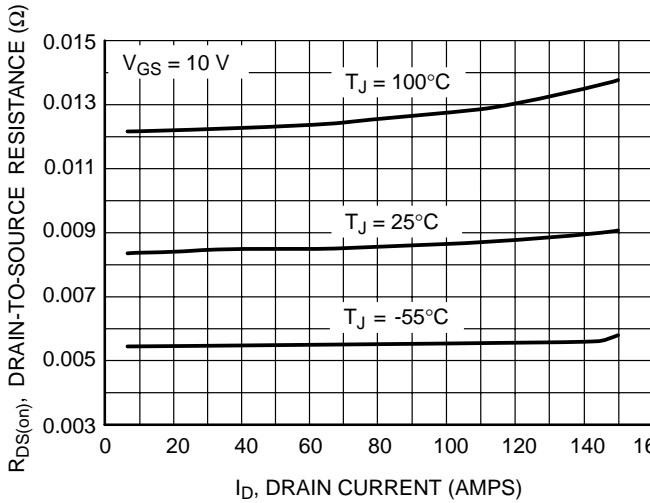

Figure 3. On-Resistance vs. Gate-to-Source Voltage

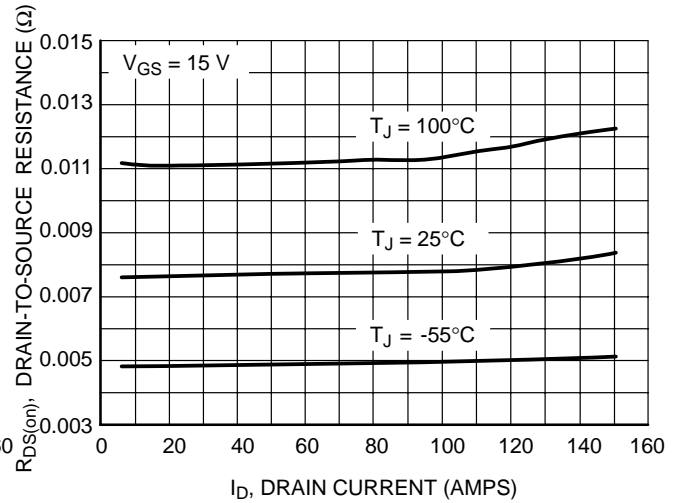

Figure 4. On-Resistance vs. Drain Current and Gate Voltage

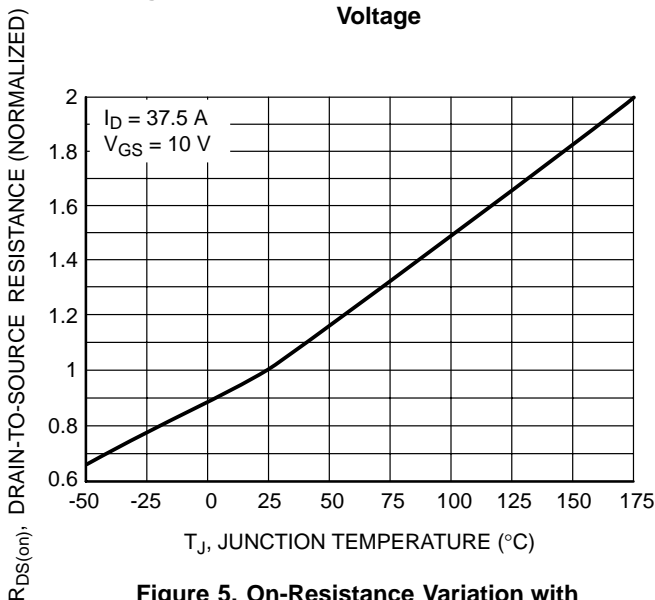

Figure 5. On-Resistance Variation with Temperature

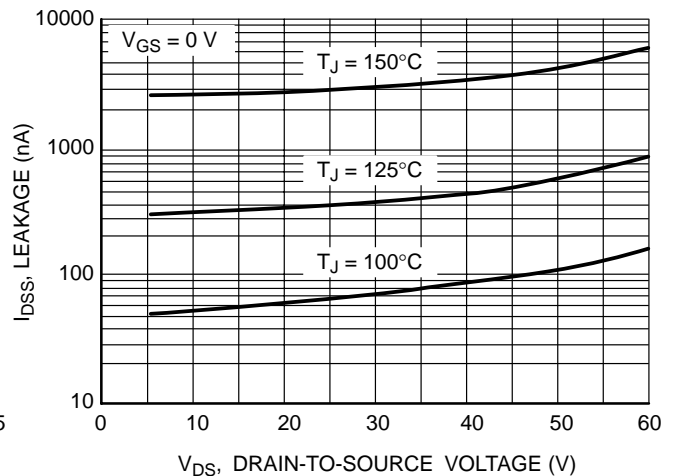

Figure 6. Drain-to-Source Leakage Current vs. Voltage

NTP75N06, NTB75N06

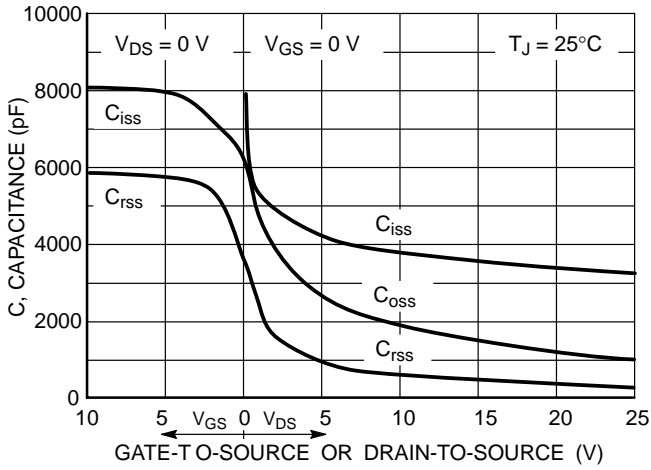

Figure 7. Capacitance Variation

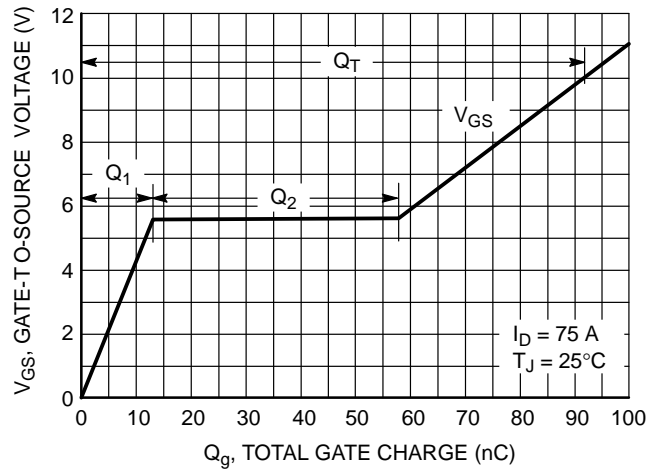

Figure 8. Gate-to-Source and Drain-to-Source Voltage vs. Total Charge

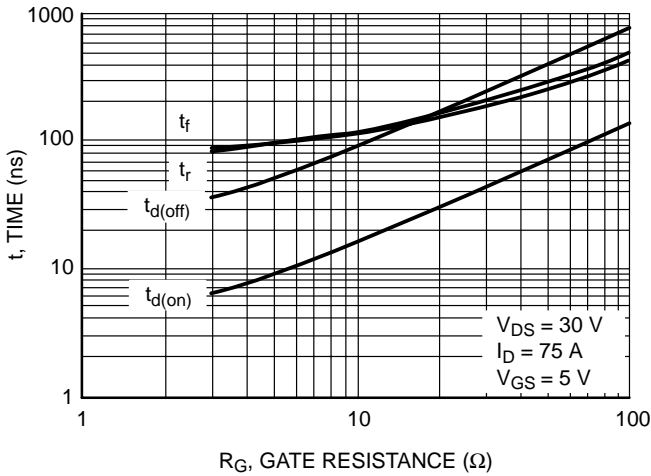

Figure 9. Resistive Switching Time Variations vs. Gate Resistance

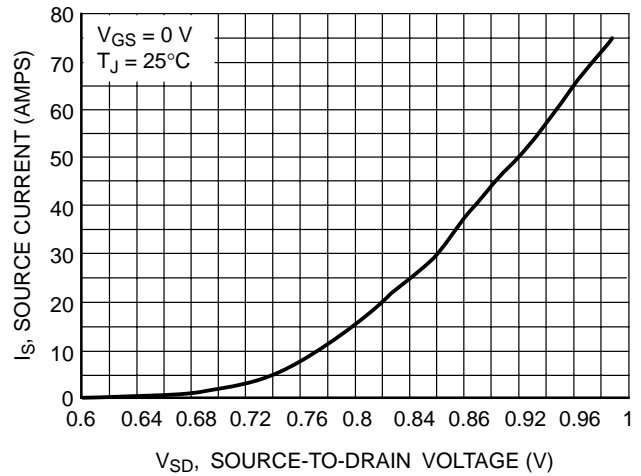

Figure 10. Diode Forward Voltage vs. Current

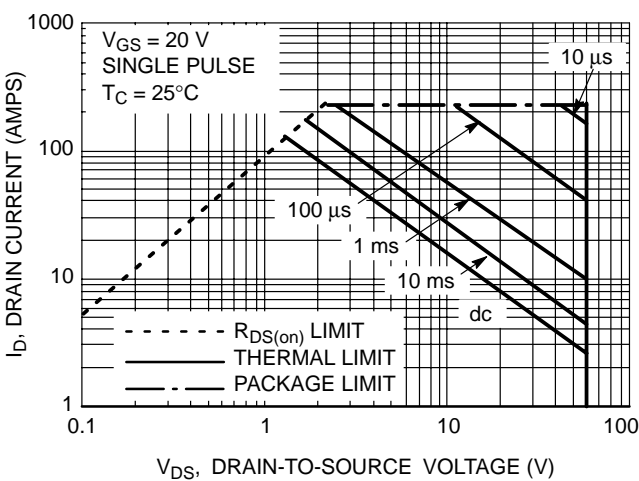

Figure 11. Maximum Rated Forward Biased Safe Operating Area

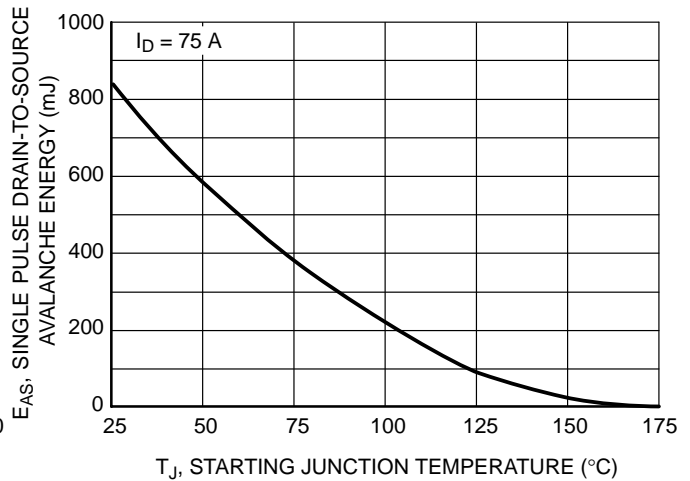

Figure 12. Maximum Avalanche Energy vs. Starting Junction Temperature

NTP75N06, NTB75N06

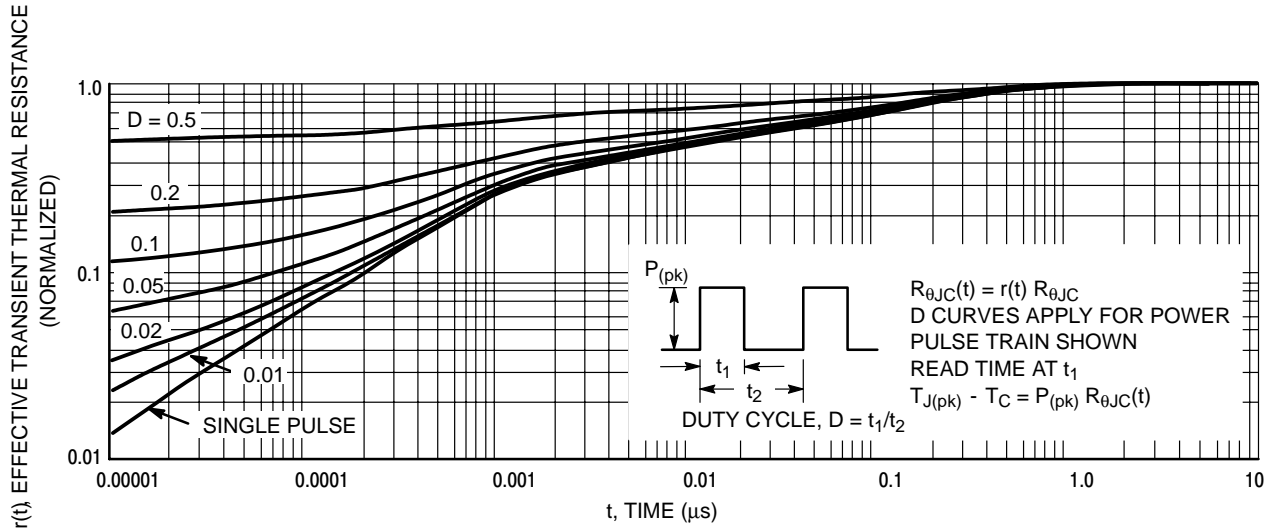
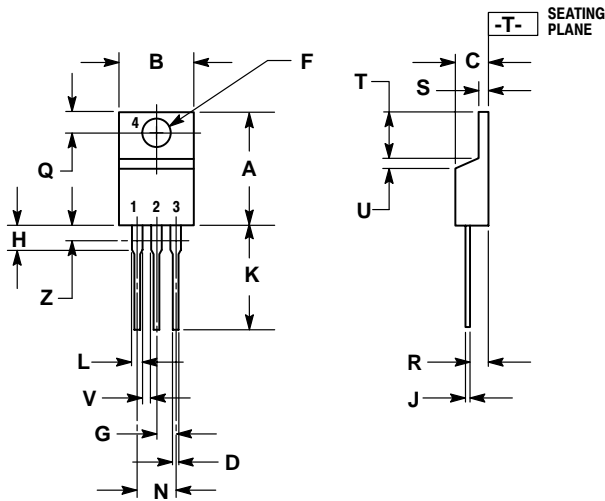

Figure 13. Thermal Response

PACKAGE DIMENSIONS

TO-220 THREE-LEAD
TO-220AB
CASE 221A-09
ISSUE AA



- NOTES:
1. DIMENSIONING AND TOLERANCING PER ANSI Y14.5M, 1982.
 2. CONTROLLING DIMENSION: INCH.
 3. DIMENSION Z DEFINES A ZONE WHERE ALL BODY AND LEAD IRREGULARITIES ARE ALLOWED.

DIM	INCHES		MILLIMETERS	
	MIN	MAX	MIN	MAX
A	0.570	0.620	14.48	15.75
B	0.380	0.405	9.66	10.28
C	0.160	0.190	4.07	4.82
D	0.025	0.035	0.64	0.88
F	0.142	0.147	3.61	3.73
G	0.095	0.105	2.42	2.66
H	0.110	0.155	2.80	3.93
J	0.018	0.025	0.46	0.64
K	0.500	0.562	12.70	14.27
L	0.045	0.060	1.15	1.52
N	0.190	0.210	4.83	5.33
Q	0.100	0.120	2.54	3.04
R	0.080	0.110	2.04	2.79
S	0.045	0.055	1.15	1.39
T	0.235	0.255	5.97	6.47
U	0.000	0.050	0.00	1.27
V	0.045	---	1.15	---
Z	---	0.080	---	2.04

- STYLE 5:
PIN 1. GATE
2. DRAIN
3. SOURCE
4. DRAIN

NTP75N06, NTB75N06

PACKAGE DIMENSIONS

D²PAK
CASE 418B-04
ISSUE H

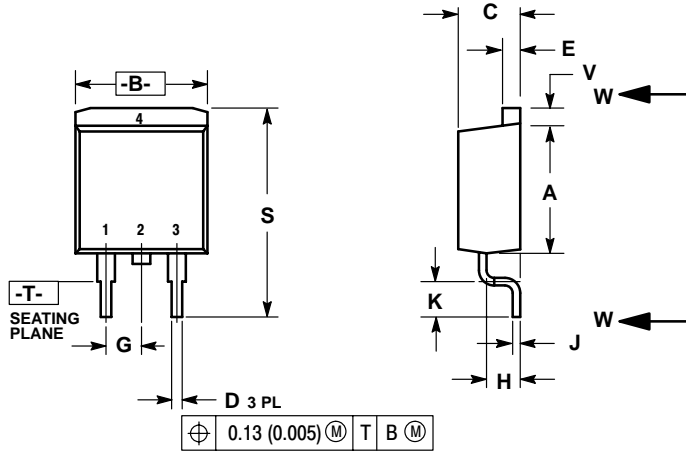

- NOTES:
1. DIMENSIONING AND TOLERANCING PER ANSI Y14.5M, 1982.
 2. CONTROLLING DIMENSION: INCH.
 3. 418B-01 THRU 418B-03 OBSOLETE, NEW STANDARD 418B-04.

DIM	INCHES		MILLIMETERS	
	MIN	MAX	MIN	MAX
A	0.340	0.380	8.64	9.65
B	0.380	0.405	9.65	10.29
C	0.160	0.190	4.06	4.83
D	0.020	0.035	0.51	0.89
E	0.045	0.055	1.14	1.40
F	0.310	0.350	7.87	8.89
G	0.100 BSC		2.54 BSC	
H	0.080	0.110	2.03	2.79
J	0.018	0.025	0.46	0.64
K	0.090	0.110	2.29	2.79
L	0.052	0.072	1.32	1.83
M	0.280	0.320	7.11	8.13
N	0.197 REF		5.00 REF	
P	0.079 REF		2.00 REF	
R	0.039 REF		0.99 REF	
S	0.575	0.625	14.60	15.88
V	0.045	0.055	1.14	1.40

- STYLE 2:
PIN 1. GATE
2. DRAIN
3. SOURCE
4. DRAIN

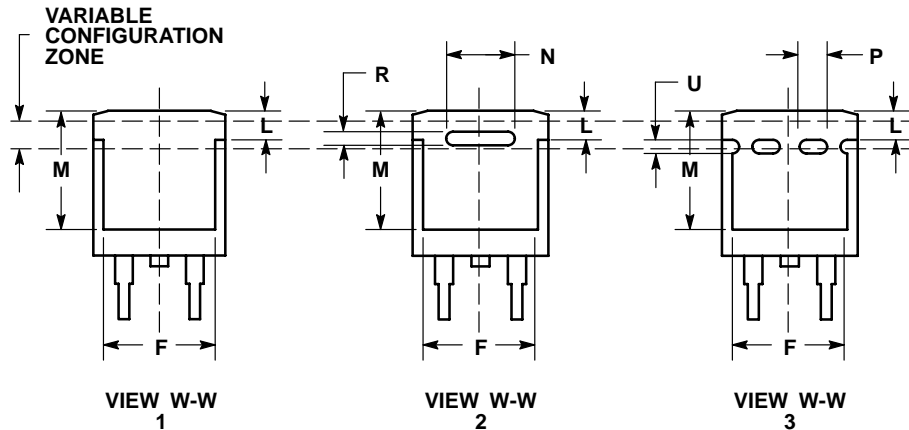

ON Semiconductor and are registered trademarks of Semiconductor Components Industries, LLC (SCILLC). SCILLC reserves the right to make changes without further notice to any products herein. SCILLC makes no warranty, representation or guarantee regarding the suitability of its products for any particular purpose, nor does SCILLC assume any liability arising out of the application or use of any product or circuit, and specifically disclaims any and all liability, including without limitation special, consequential or incidental damages. "Typical" parameters which may be provided in SCILLC data sheets and/or specifications can and do vary in different applications and actual performance may vary over time. All operating parameters, including "Typicals" must be validated for each customer application by customer's technical experts. SCILLC does not convey any license under its patent rights nor the rights of others. SCILLC products are not designed, intended, or authorized for use as components in systems intended for surgical implant into the body, or other applications intended to support or sustain life, or for any other application in which the failure of the SCILLC product could create a situation where personal injury or death may occur. Should Buyer purchase or use SCILLC products for any such unintended or unauthorized application, Buyer shall indemnify and hold SCILLC and its officers, employees, subsidiaries, affiliates, and distributors harmless against all claims, costs, damages, and expenses, and reasonable attorney fees arising out of, directly or indirectly, any claim of personal injury or death associated with such unintended or unauthorized use, even if such claim alleges that SCILLC was negligent regarding the design or manufacture of the part. SCILLC is an Equal Opportunity/Affirmative Action Employer.

PUBLICATION ORDERING INFORMATION

Literature Fulfillment:
Literature Distribution Center for ON Semiconductor
P.O. Box 5163, Denver, Colorado 80217 USA
Phone: 303-675-2175 or 800-344-3860 Toll Free USA/Canada
Fax: 303-675-2176 or 800-344-3867 Toll Free USA/Canada
Email: ONlit@hibbertco.com

N. American Technical Support: 800-282-9855 Toll Free USA/Canada

JAPAN: ON Semiconductor, Japan Customer Focus Center
2-9-1 Kamimeguro, Meguro-ku, Tokyo, Japan 153-0051
Phone: 81-3-5773-3850

ON Semiconductor Website: <http://onsemi.com>

For additional information, please contact your local Sales Representative.