

NIF62514

Preferred Device

Self-Protected FET with Temperature and Current Limit

HDPlus devices are an advanced series of power MOSFETs which utilize ON Semiconductor's latest MOSFET technology process to achieve the lowest possible on-resistance per silicon area while incorporating smart features. Integrated thermal and current limits work together to provide short circuit protection. The devices feature an integrated Drain-to-Gate Clamp that enables them to withstand high energy in the avalanche mode. The Clamp also provides additional safety margin against unexpected voltage transients. Electrostatic Discharge (ESD) protection is provided by an integrated Gate-to-Source Clamp.

Features

- Current Limitation
- Thermal Shutdown with Automatic Restart
- Short Circuit Protection
- Low $R_{DS(on)}$
- I_{DSS} Specified at Elevated Temperature
- Avalanche Energy Specified
- Slew Rate Control for Low Noise Switching
- Overvoltage Clamped Protection
- Pb-Free Packages are Available

MOSFET MAXIMUM RATINGS ($T_J = 25^\circ\text{C}$ unless otherwise noted)

Rating	Symbol	Value	Unit
Drain-to-Source Voltage Internally Clamped	V_{DSS}	40	Vdc
Drain-to-Gate Voltage Internally Clamped ($R_{GS} = 1.0\text{ M}\Omega$)	V_{DGR}	40	Vdc
Gate-to-Source Voltage	V_{GS}	± 16	Vdc
Drain Current - Continuous @ $T_A = 25^\circ\text{C}$ - Continuous @ $T_A = 100^\circ\text{C}$ - Pulsed ($t_p \leq 10\ \mu\text{s}$)	I_D I_{D1} I_{DM}	Internally Limited	
Total Power Dissipation @ $T_A = 25^\circ\text{C}$ (Note 1) @ $T_A = 25^\circ\text{C}$ (Note 2) @ $T_A = 25^\circ\text{C}$ (Note 3)	P_D	1.1 1.73 8.93	W
Thermal Resistance, Junction-to-Tab Junction-to-Ambient (Note 1) Junction-to-Ambient (Note 2)	$R_{\theta JT}$ $R_{\theta JA}$ $R_{\theta JA}$	14 114 72.3	$^\circ\text{C/W}$
Single Pulse Drain-to-Source Avalanche Energy ($V_{DD} = 25\text{ Vdc}$, $V_{GS} = 5.0\text{ Vdc}$, $V_{DS} = 40\text{ Vdc}$, $I_L = 2.8\text{ Apk}$, $L = 80\text{ mH}$, $R_G = 25\ \Omega$)	E_{AS}	300	mJ
Operating and Storage Temperature Range	T_J, T_{stg}	-55 to 150	$^\circ\text{C}$

Stresses exceeding Maximum Ratings may damage the device. Maximum Ratings are stress ratings only. Functional operation above the Recommended Operating Conditions is not implied. Extended exposure to stresses above the Recommended Operating Conditions may affect device reliability.

1. Mounted onto min pad board.
2. Mounted onto 1" pad board.
3. Mounted onto large heatsink.



ON Semiconductor®

<http://onsemi.com>

6.0 AMPERES*
40 VOLTS CLAMPED
 $R_{DS(on)} = 90\text{ m}\Omega$

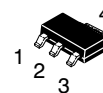
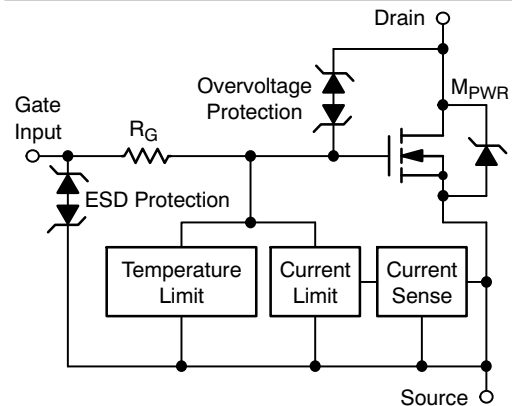

SOT-223
CASE 318E
STYLE 3

MARKING DIAGRAM

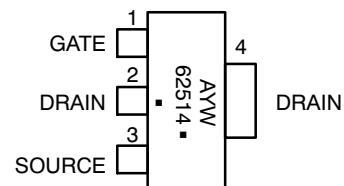

A = Assembly Location
Y = Year
W = Work Week
62514 = Specific Device Code
▪ = Pb-Free Package
(Note: Microdot may be in either location)

ORDERING INFORMATION

See detailed ordering and shipping information in the package dimensions section on page 5 of this data sheet.

Preferred devices are recommended choices for future use and best overall value.

*Limited by the current limit circuit.

NIF62514

MOSFET ELECTRICAL CHARACTERISTICS (T_J = 25°C unless otherwise noted)

Characteristic	Symbol	Min	Typ	Max	Unit
----------------	--------	-----	-----	-----	------

OFF CHARACTERISTICS

Drain-to-Source Clamped Breakdown Voltage (V _{GS} = 0 Vdc, I _D = 250 μAdc) (V _{GS} = 0 Vdc, I _D = 250 μAdc, T _J = 150°C)	V _{(BR)DSS}	42 42	46 45	50 50	Vdc
Zero Gate Voltage Drain Current (V _{DS} = 32 Vdc, V _{GS} = 0 Vdc) (V _{DS} = 32 Vdc, V _{GS} = 0 Vdc, T _J = 150°C)	I _{DSS}	- -	0.5 2.0	2.0 10	μAdc
Gate Input Current (V _{GS} = 5.0 Vdc, V _{DS} = 0 Vdc) (V _{GS} = -5.0 Vdc, V _{DS} = 0 Vdc)	I _{GSS}	- -	50 550	100 1000	μAdc

ON CHARACTERISTICS

Gate Threshold Voltage (V _{DS} = V _{GS} , I _D = 150 μAdc) Threshold Temperature Coefficient (Negative)	V _{GS(th)}	1.0 -	1.7 4.0	2.0 6.0	Vdc mV/°C
Static Drain-to-Source On-Resistance (Note 4) (V _{GS} = 10 Vdc, I _D = 1.4 Adc, T _J @ 25°C) (V _{GS} = 10 Vdc, I _D = 1.4 Adc, T _J @ 150°C)	R _{DS(on)}	- -	90 165	100 190	mΩ
Static Drain-to-Source On-Resistance (Note 4) (V _{GS} = 5.0 Vdc, I _D = 1.4 Adc, T _J @ 25°C) (V _{GS} = 5.0 Vdc, I _D = 1.4 Adc, T _J @ 150°C)	R _{DS(on)}	- -	105 185	120 210	mΩ
Source-Drain Forward On Voltage (I _S = 7 A, V _{GS} = 0 V)	V _{SD}	-	1.05	-	V

SWITCHING CHARACTERISTICS

Turn-on Delay Time R _L = 4.7 Ω, V _{in} = 0 to 10 V, V _{DD} = 12 V	t _{d(on)}	-	4.0	8.0	μs
Turn-on Rise Time R _L = 4.7 Ω, V _{in} = 0 to 10 V, V _{DD} = 12 V	t _{rise}	-	11	20	μs
Turn-off Delay Time R _L = 4.7 Ω, V _{in} = 10 to 0 V, V _{DD} = 12 V	t _{d(off)}	-	32	50	μs
Turn-off Fall Time R _L = 4.7 Ω, V _{in} = 10 to 0 V, V _{DD} = 12 V	t _{fall}	-	27	50	μs
Slew-Rate On R _L = 4.7 Ω, V _{in} = 0 to 10 V, V _{DD} = 12 V	-dV _{DS} /dt _{on}	-	1.5	2.5	μs
Slew-Rate Off R _L = 4.7 Ω, V _{in} = 10 to 0 V, V _{DD} = 12 V	dV _{DS} /dt _{off}	-	0.6	1.0	μs

SELF PROTECTION CHARACTERISTICS (T_J = 25°C unless otherwise noted)

Current Limit (V _{GS} = 5.0 Vdc) (V _{GS} = 5.0 Vdc, T _J = 150°C)	I _{LIM}	6.0 3.0	9.0 5.0	11 8.0	Adc
Current Limit (V _{GS} = 10 Vdc) (V _{GS} = 10 Vdc, T _J = 150°C)	I _{LIM}	7.0 4.0	10.5 7.5	13 10	Adc
Temperature Limit (Turn-off)	T _{LIM(off)}	150	175	200	°C
Temperature Limit (Circuit Reset)	T _{LIM(on)}	135	160	185	°C
Temperature Limit (Turn-off)	T _{LIM(off)}	150	155	185	°C
Temperature Limit (Circuit Reset)	T _{LIM(on)}	130	140	170	°C

ESD ELECTRICAL CHARACTERISTICS (T_J = 25°C unless otherwise noted)

Electro-Static Discharge Capability	Human Body Model (HBM)	ESD	4000	-	-	V
Electro-Static Discharge Capability	Machine Model (MM)	ESD	400	-	-	V

4. Pulse Test: Pulse Width = 300 μs, Duty Cycle = 2%.

TYPICAL ELECTRICAL CHARACTERISTICS

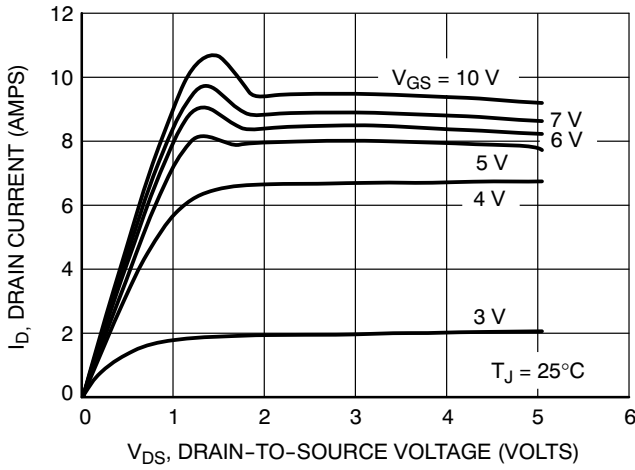

Figure 1. Output Characteristics

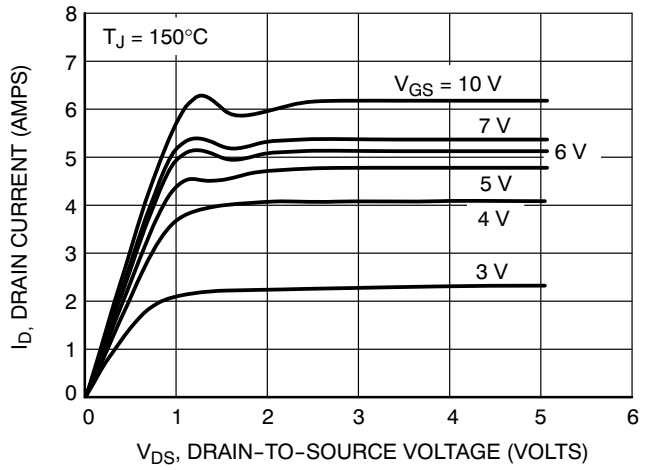

Figure 2. Output Characteristics

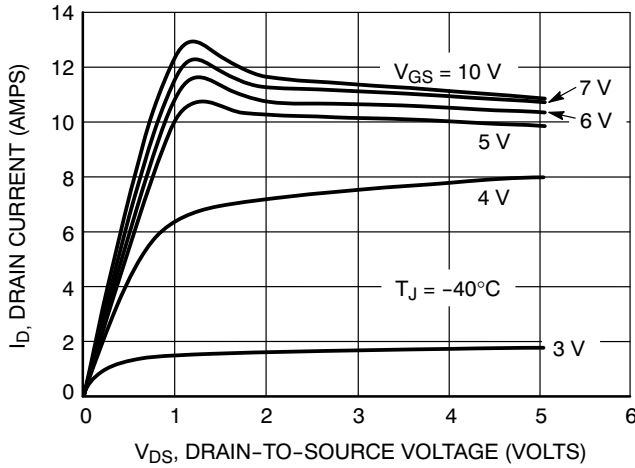

Figure 3. Output Characteristics

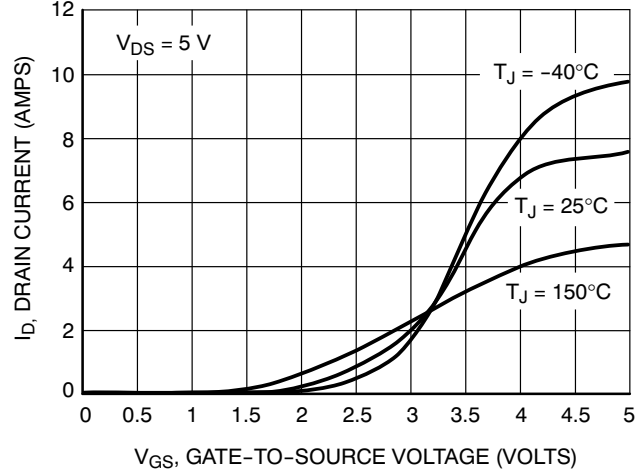

Figure 4. Transfer Characteristics

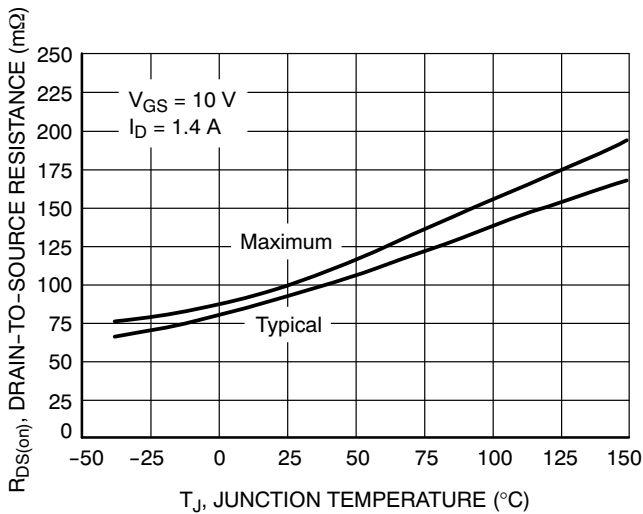

Figure 5. Drain-to-Source Resistance versus Junction Temperature

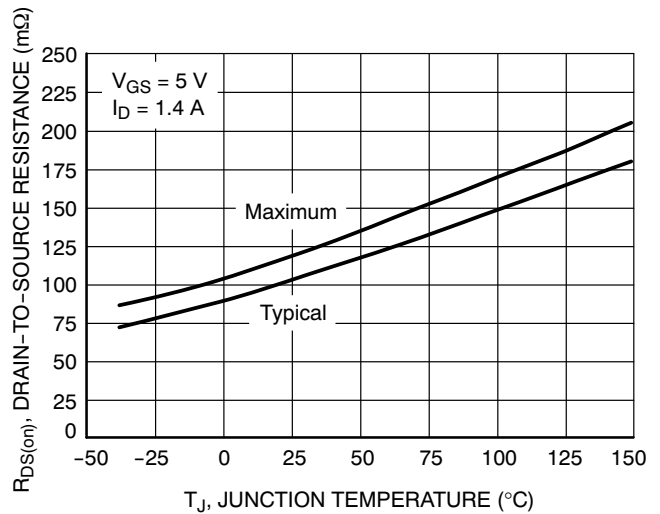

Figure 6. Drain-to-Source Resistance versus Junction Temperature

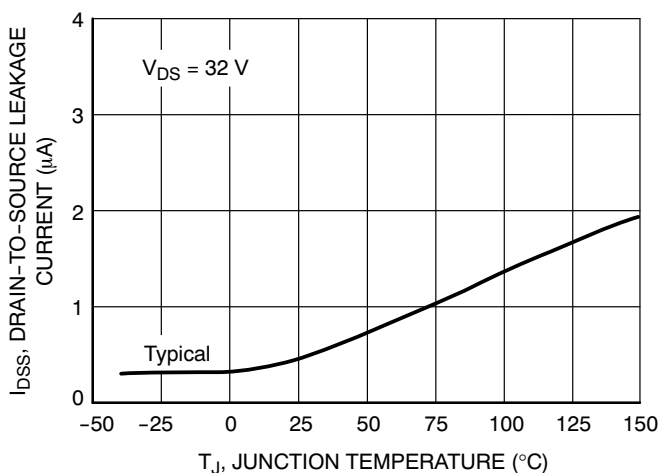

Figure 7. Drain-to-Source Resistance versus Junction Temperature

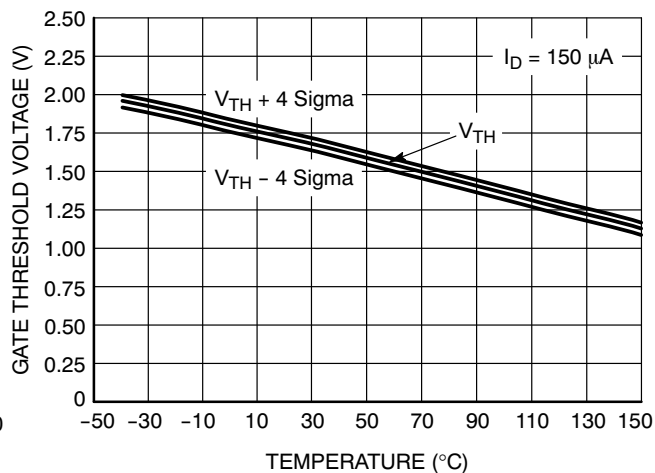

Figure 8. Gate Threshold Voltage versus Temperature

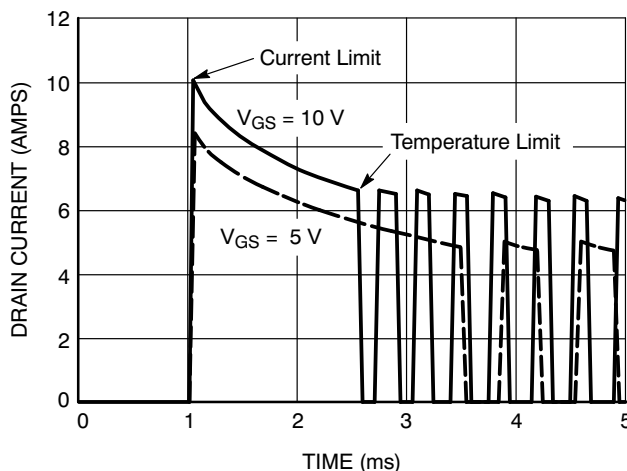

Figure 9. Short-circuit Response

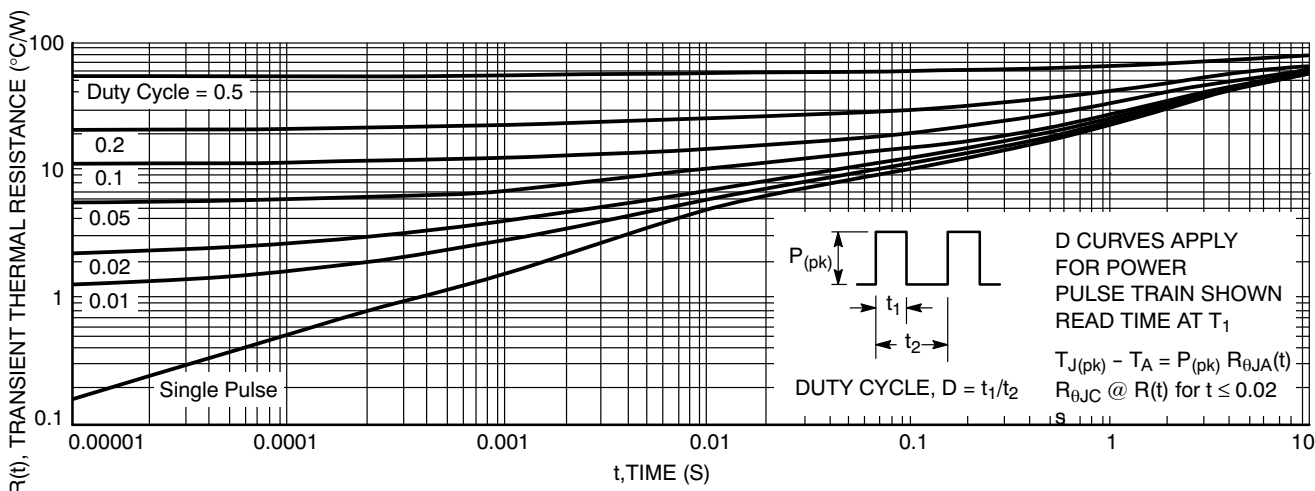

Figure 10. Transient Thermal Resistance (Non-normalized Junction-to-Ambient mounted on minimum pad area)

NIF62514

ORDERING INFORMATION

Device	Package	Shipping†
NIF62514T1	SOT-223	1000 / Tape & Reel
NIF62514T1G	SOT-223 (Pb-Free)	
NIF62514T3G	SOT-223 (Pb-Free)	4000 / Tape & Reel

†For information on tape and reel specifications, including part orientation and tape sizes, please refer to our Tape and Reel Packaging Specifications Brochure, BRD8011/D.

NIF62514

PACKAGE DIMENSIONS

SOT-223 (TO-261)
CASE 318E-04
ISSUE M

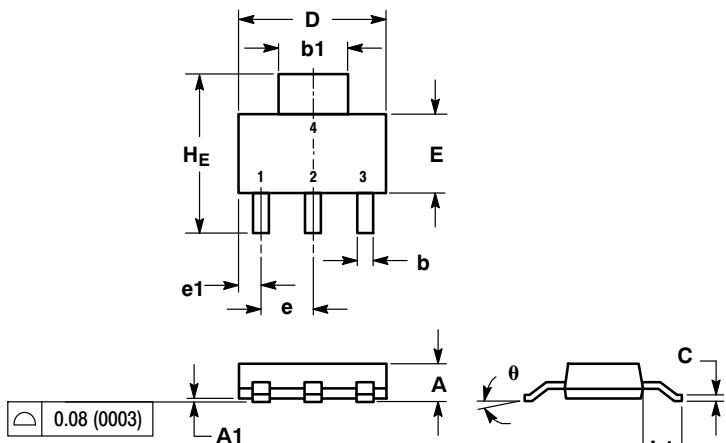

NOTES:

1. DIMENSIONING AND TOLERANCING PER ANSI Y14.5M, 1982.
2. CONTROLLING DIMENSION: INCH.

DIM	MILLIMETERS			INCHES		
	MIN	NOM	MAX	MIN	NOM	MAX
A	1.50	1.63	1.75	0.060	0.064	0.068
A1	0.02	0.06	0.10	0.001	0.002	0.004
b	0.60	0.75	0.89	0.024	0.030	0.035
b1	2.90	3.06	3.20	0.115	0.121	0.126
c	0.24	0.29	0.35	0.009	0.012	0.014
D	6.30	6.50	6.70	0.249	0.256	0.263
E	3.30	3.50	3.70	0.130	0.138	0.145
e	2.20	2.30	2.40	0.087	0.091	0.094
e1	0.85	0.94	1.05	0.033	0.037	0.041
L1	1.50	1.75	2.00	0.060	0.069	0.078
HE	6.70	7.00	7.30	0.264	0.276	0.287
θ	0°	-	10°	0°	-	10°

STYLE 3:

- PIN 1. GATE
- DRAIN
- SOURCE
- DRAIN

SOLDERING FOOTPRINT

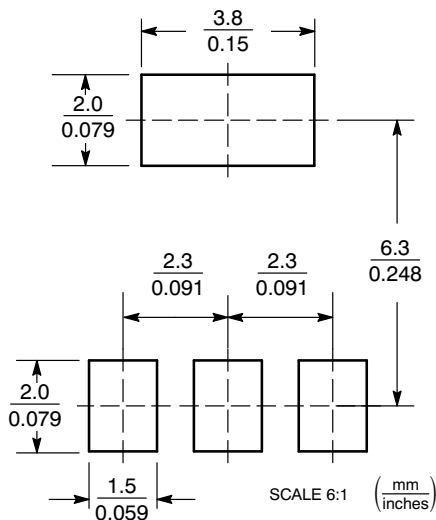

*For additional information on our Pb-Free strategy and soldering details, please download the ON Semiconductor Soldering and Mounting Techniques Reference Manual, SOLDERRM/D.

ON Semiconductor and are registered trademarks of Semiconductor Components Industries, LLC (SCILLC). SCILLC reserves the right to make changes without further notice to any products herein. SCILLC makes no warranty, representation or guarantee regarding the suitability of its products for any particular purpose, nor does SCILLC assume any liability arising out of the application or use of any product or circuit, and specifically disclaims any and all liability, including without limitation special, consequential or incidental damages. "Typical" parameters which may be provided in SCILLC data sheets and/or specifications can and do vary in different applications and actual performance may vary over time. All operating parameters, including "Typicals" must be validated for each customer application by customer's technical experts. SCILLC does not convey any license under its patent rights nor the rights of others. SCILLC products are not designed, intended, or authorized for use as components in systems intended for surgical implant into the body, or other applications intended to support or sustain life, or for any other application in which the failure of the SCILLC product could create a situation where personal injury or death may occur. Should Buyer purchase or use SCILLC products for any such unintended or unauthorized application, Buyer shall indemnify and hold SCILLC and its officers, employees, subsidiaries, affiliates, and distributors harmless against all claims, costs, damages, and expenses, and reasonable attorney fees arising out of, directly or indirectly, any claim of personal injury or death associated with such unintended or unauthorized use, even if such claim alleges that SCILLC was negligent regarding the design or manufacture of the part. SCILLC is an Equal Opportunity/Affirmative Action Employer. This literature is subject to all applicable copyright laws and is not for resale in any manner.

PUBLICATION ORDERING INFORMATION

LITERATURE FULFILLMENT:

Literature Distribution Center for ON Semiconductor
P.O. Box 5163, Denver, Colorado 80217 USA
Phone: 303-675-2175 or 800-344-3860 Toll Free USA/Canada
Fax: 303-675-2176 or 800-344-3867 Toll Free USA/Canada
Email: orderlit@onsemi.com

N. American Technical Support: 800-282-9855 Toll Free
USA/Canada
Europe, Middle East and Africa Technical Support:
Phone: 421 33 790 2910
Japan Customer Focus Center
Phone: 81-3-5773-3850

ON Semiconductor Website: www.onsemi.com

Order Literature: <http://www.onsemi.com/orderlit>

For additional information, please contact your local Sales Representative

NIF62514/D