

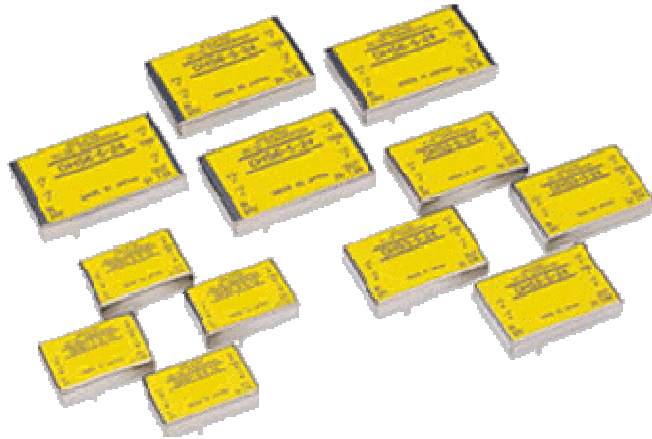

# ETA-USA

## HIGH QUALITY SWITCHING POWER SUPPLIES

DC/DC SWITCHING POWER SUPPLY  
DC INPUT 5,12,24,48  
SINGLE OUTPUT  
6 WATTS



### PMR6-SC-NG SERIES

#### General Description

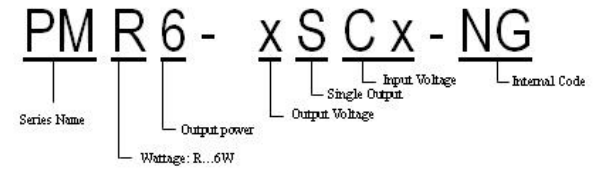

Dimension [mm]: 44.5×28×7 (W×D×H)

#### DC INPUT: 5V

Input Characteristics	Unit	PMR6-3.3SC05-NG	PMR6-05SC05-NG	PMR6-12SC05-NG	PMR6-15SC05-NG
Rated input voltage	V <sub>dc</sub>	DC 5V			
Input voltage range	V <sub>dc</sub>	DC 4.5~9V			
Input current (typ.)	A	1.13	1.66	1.58	1.56
Efficiency *1	%	70%	72%	76%	77%

#### DC INPUT: 12V

Input Characteristics	Unit	PMR6-3.3SC12-NG	PMR6-05SC12-NG	PMR6-12SC12-NG	PMR6-15SC12-NG
Rated input voltage	V <sub>dc</sub>	DC 12V			
Input voltage range	V <sub>dc</sub>	DC 9~18V			
Input current (typ.)	A	0.45	0.65	0.62	0.61
Efficiency *1	%	74%	77%	81%	82%

#### DC INPUT: 24V

Input Characteristics	Unit	PMR6-3.3SC24-NG	PMR6-05SC24-NG	PMR6-12SC24-NG	PMR6-15SC24-NG
Rated input voltage	V <sub>dc</sub>	DC 24V			
Input voltage range	V <sub>dc</sub>	DC 18 ~ 36V			
Input current (typ.)	A	0.23	0.33	0.31	0.3
Efficiency *1	%	72%	76%	79%	81%

#### DC INPUT: 48V

Input Characteristics	Unit	PMR6-3.3SC48-NG	PMR6-05SC48-NG	PMR6-12SC48-NG	PMR6-15SC48-NG
Rated input voltage	V <sub>dc</sub>	DC 48V			
Input voltage range	V <sub>dc</sub>	DC 36 ~ 75V			
Input current (typ.)	A	0.11	0.16	0.15	0.15
Efficiency *1	%	74%	79%	82%	83%



ETA USA  
16170 Vineyard Blvd. Suite 180, Morgan Hill, CA 95037  
Phone: 1-800-ETA-POWER, (408) 778-2793 Fax: (408) 779-2753

Visit us at: [www.eta-usa.com](http://www.eta-usa.com)  
email at: [sales@eta-usa.com](mailto:sales@eta-usa.com)



# ETA-USA

## HIGH QUALITY SWITCHING POWER SUPPLIES

### PMR6-xSCx-NG

Output Characteristic	Unit	Models			
		PMR6-3.3SCx-NG	PMR6-05SCx-NG	PMR6-12SCx-NG	PMR6-15SCx-NG
Rated Output Voltage	V <sub>dc</sub>	3.3	5	12	15
Rated Output Power	W	3.96	6	6	6
Rated Output Current	A	1.2	1.2	0.5	0.4
Output voltage range *1	%	±3%			
Ripple Noise( Max.)	mV p-p	60	60	90	90
<b>Regulation</b>					
a. Line Regulation	mV	20	20	48	60
b. Load Regulation	mV	40	40	100	120
c. Temperature Regulation*2	mV	50	50	150	180

Environmental Specification	
Operating Temperature *4	Convection cooling:-20~+71°C Forced air cooling:-20~+85°C
Operating Humidity	20~95%RH (No dew condensation permitted)
Storage Temperature	-40~+85°C
Storage Humidity	20~95%RH (No dew condensation permitted)
Cooling	Convection cooling / Forced air cooling

Dielectric Strength	
Withstand Voltage	Input-FG 500VAC for 1 min. Input-Output 500VAC for 1 min. Output-FG 500VAC for 1min.
Insulation Resistance	Input-FG 50MΩ at 500VDC Input-Output 50MΩ at 500VDC Output-FG 50MΩ at 500VDC

Functions				
Over Current Protection	Automatic recovery			
	1.26A~	1.26A~	0.53A~	0.42A~
Over Voltage Protection	N/A			
	3.8V~	5.75V~	13.8V~	17.3V~
Trimming of output voltage *3	+10% -15%	±10%		
Input fuse	Built-in			

Structure & Others	
Vibration Resistance	10~55Hz Acceleration:98m/s <sup>2</sup> (10G) Cycle: 3min. Direction: X,Y,Z for 1 hour each
Shock Resistance	Acceleration:490.3m/s <sup>2</sup> (50G) Time: 11ms Direction: X,Y,Z for 1hour each

Mechanical	
Dimension [mm]	44.5×28×7 (W×D×H)
Weight [g] (typical)	20g

Conditions:

\*1 At Rated input voltage, Rated output current, Operating temp. 25°C

\*2 At operating temp. -20~+71°C

\*3 Possible by inserting appointed resistor at outside.

\*4 Load should be reduced for operation at 55°C or above at convection cooling, and at 70°C or above at forced air cooling.



ETA USA  
16170 Vineyard Blvd. Suite 180, Morgan Hill, CA 95037  
Phone: 1-800-ETA-POWER, (408) 778-2793 Fax: (408) 779-2753

Visit us at: [www.eta-usa.com](http://www.eta-usa.com)  
email at: [sales@eta-usa.com](mailto:sales@eta-usa.com)



# ETA-USA

## HIGH QUALITY SWITCHING POWER SUPPLIES

### BLOCK DIAGRAM

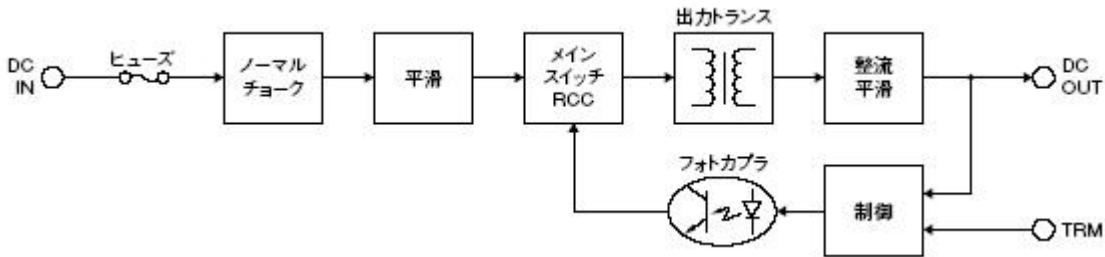

### DIMENSION DIAGRAM (mm)

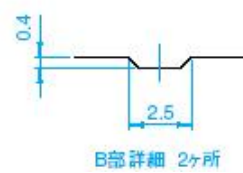
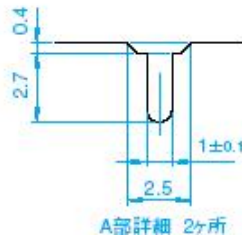
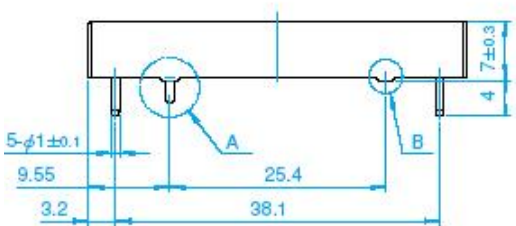
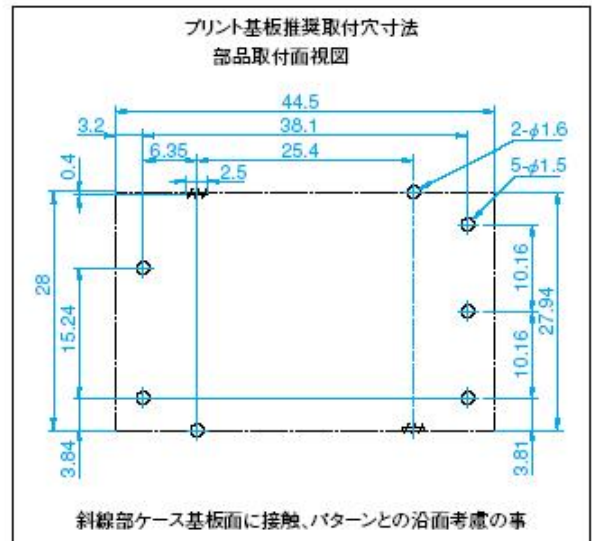
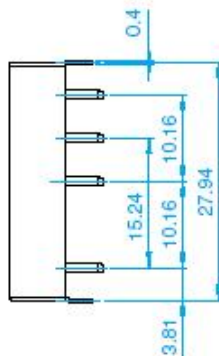
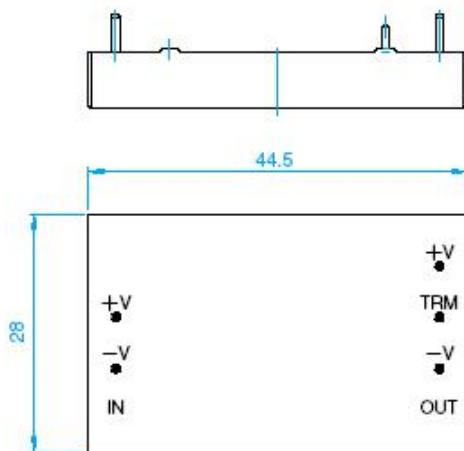

ETA USA  
16170 Vineyard Blvd. Suite 180, Morgan Hill, CA 95037  
Phone: 1-800-ETA-POWER, (408) 778-2793 Fax: (408) 779-2753

Visit us at: [www.eta-usa.com](http://www.eta-usa.com)  
email at: [sales@eta-usa.com](mailto:sales@eta-usa.com)