

NDP408A / NDP408AE / NDP408B / NDP408BE NDB408A / NDB408AE / NDB408B / NDB408BE N-Channel Enhancement Mode Field Effect Transistor

General Description

These N-channel enhancement mode power field effect transistors are produced using Fairchild's proprietary, high cell density, DMOS technology. This very high density process has been especially tailored to minimize on-state resistance, provide superior switching performance, and withstand high energy pulses in the avalanche and commutation modes. These devices are particularly suited for low voltage applications such as automotive, DC/DC converters, PWM motor controls, and other battery powered circuits where fast switching, low in-line power loss, and resistance to transients are needed.

Features

- 12 and 11A, 80V. $R_{DS(ON)} = 0.16$ and 0.20Ω .
- Critical DC electrical parameters specified at elevated temperature.
- Rugged internal source-drain diode can eliminate the need for an external Zener diode transient suppressor.
- 175°C maximum junction temperature rating.
- High density cell design (3 million/in²) for extremely low $R_{DS(ON)}$.
- TO-220 and TO-263 (D²PAK) package for both through hole and surface mount applications.

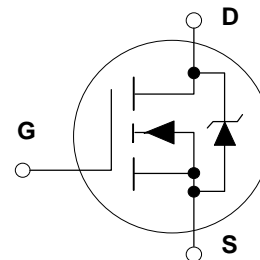
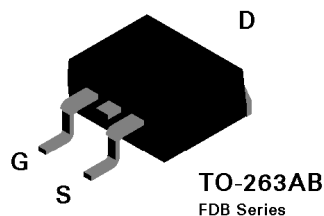
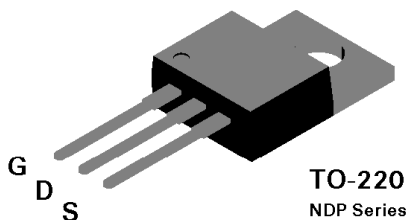

Absolute Maximum Ratings

$T_C = 25^\circ\text{C}$ unless otherwise noted

Symbol	Parameter	NDP408A NDB408A	NDP408AE NDB408AE	NDP408B NDB408B	NDP408BE NDB408BE	Units
V_{DSS}	Drain-Source Voltage	80		80		V
V_{DGR}	Drain-Gate Voltage ($R_{GS} \leq 1\text{ M}\Omega$)	80		80		V
V_{GSS}	Gate-Source Voltage - Continuous - Nonrepetitive ($t_p < 50\ \mu\text{s}$)	± 20		± 20		V
		± 40		± 40		V
I_D	Drain Current - Continuous - Pulsed	12		11		A
		36		33		A
P_D	Total Power Dissipation @ $T_C = 25^\circ\text{C}$ Derate above 25°C	50		50		W
		0.33		0.33		W/°C
T_J, T_{STG}	Operating and Storage Temperature Range	-65 to 175		-65 to 175		°C
T_L	Maximum lead temperature for soldering purposes, 1/8" from case for 5 seconds	275		275		°C

Electrical Characteristics (T_c = 25°C unless otherwise noted)

Symbol	Parameter	Conditions	Type	Min	Typ	Max	Units
DRAIN-SOURCE AVALANCHE RATINGS (Note 1)							
E _{AS}	Single Pulse Drain-Source Avalanche Energy	V _{DD} = 25 V, I _D = 12 A	NDP408AE NDP408BE			40	mJ
I _{AR}	Maximum Drain-Source Avalanche Current		NDB408AE NDB408BE			12	A
OFF CHARACTERISTICS							
BV _{DSS}	Drain-Source Breakdown Voltage	V _{GS} = 0 V, I _D = 250 μA	ALL	80			V
I _{DSS}	Zero Gate Voltage Drain Current	V _{DS} = 80 V, V _{GS} = 0 V	ALL			250	μA
		T _J = 125°C				1	mA
I _{GSSF}	Gate - Body Leakage, Forward	V _{GS} = 20 V, V _{DS} = 0 V	ALL			100	nA
I _{GSSR}	Gate - Body Leakage, Reverse	V _{GS} = -20 V, V _{DS} = 0 V	ALL			-100	nA
ON CHARACTERISTICS (Note 2)							
V _{GS(th)}	Gate Threshold Voltage	V _{DS} = V _{GS} , I _D = 250 μA	ALL	2	2.9	4	V
		T _J = 125°C		1.4	2.3	3.6	V
R _{DS(ON)}	Static Drain-Source On-Resistance	V _{GS} = 10 V, I _D = 6 A	NDP408A NDP408AE NDB408A NDB408AE		0.11	0.16	Ω
		T _J = 125°C			0.19	0.32	Ω
		V _{GS} = 10 V, I _D = 5.5 A	NDP408B NDP408BE NDB408B NDB408BE			0.2	Ω
		T _J = 125°C				0.5	Ω
I _{D(on)}	On-State Drain Current	V _{GS} = 10 V, V _{DS} = 10 V	NDP408A NDP408AE NDB408A NDB408AE	11			A
			NDP408B NDP408BE NDB408B NDB408BE	10			A
g _{FS}	Forward Transconductance	V _{DS} = 10 V, I _D = 6 A	ALL	3	5.3		S
DYNAMIC CHARACTERISTICS							
C _{ISS}	Input Capacitance	V _{DS} = 25 V, V _{GS} = 0 V, f = 1.0 MHz	ALL		380	500	pF
C _{OSS}	Output Capacitance		ALL		115	125	pF
C _{ISS}	Reverse Transfer Capacitance		ALL		35	50	pF

Electrical Characteristics (T_c = 25°C unless otherwise noted)

Symbol	Parameter	Conditions	Type	Min	Typ	Max	Units	
SWITCHING CHARACTERISTICS (Note 2)								
t _{D(ON)}	Turn - On Delay Time	V _{DD} = 40 V, I _D = 12 A, V _{GS} = 10 V, R _{GEN} = 24 Ω	ALL		7.5	20	nS	
t _r	Turn - On Rise Time		ALL		48	80	nS	
t _{D(OFF)}	Turn - Off Delay Time		ALL		22	40	nS	
t _f	Turn - Off Fall Time		ALL		32	60	nS	
Q _g	Total Gate Charge	V _{DS} = 64 V, I _D = 12 A, V _{GS} = 10V	ALL		12	17	nC	
Q _{gs}	Gate-Source Charge		ALL		2.5		nC	
Q _{gd}	Gate-Drain Charge		ALL		6		nC	
DRAIN-SOURCE DIODE CHARACTERISTICS								
I _S	Maximum Continuous Drain-Source Diode Forward Current		NDP408A NDP408AE NDB408A NDB408AE			12	A	
			NDP408B NDP408BE NDB408B NDB408BE			11	A	
I _{SM}	Maximum Pulsed Drain-Source Diode Forward Current		NDP408A NDP408AE NDB408A NDB408AE			36	A	
			NDP408B NDP408BE NDB408B NDB408BE			33	A	
V _{SD} (Note 2)	Drain-Source Diode Forward Voltage	V _{GS} = 0 V, I _S = 6 A	ALL	T _J = 125°C		0.87	1.3	V
						0.74	1.2	V
t _{rr}	Reverse Recovery Time	V _{GS} = 0 V, I _S = 12 A, di _s /dt = 100 A/μs	ALL		68	100	ns	
I _{rr}	Reverse Recovery Current		ALL		4.7	7	A	
THERMAL CHARACTERISTICS								
R _{θJC}	Thermal Resistance, Junction-to-Case		ALL			3	°C/W	
R _{θJA}	Thermal Resistance, Junction-to-Ambient		ALL			62.5	°C/W	

Notes:

1. NDP408A/408B and NDB408A/408B are not rated for operation in avalanche mode.
2. Pulse Test: Pulse Width ≤ 300 μs, Duty Cycle ≤ 2.0%.

Typical Electrical Characteristics

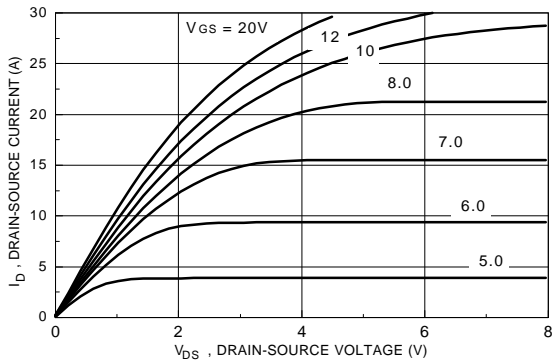

Figure 1. On-Region Characteristics.

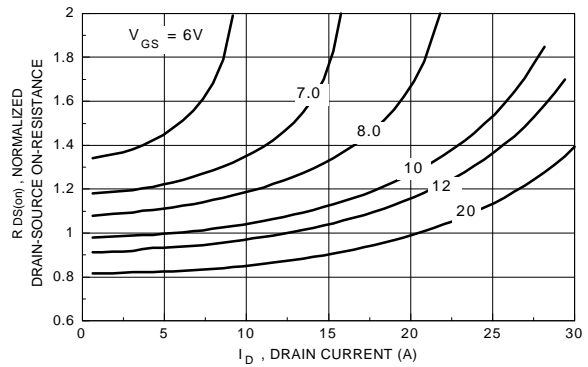

Figure 2. On-Resistance Variation with Gate Voltage and Drain Current.

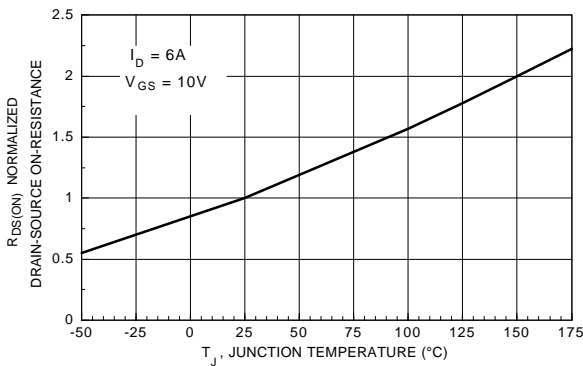

Figure 3. On-Resistance Variation with Temperature.

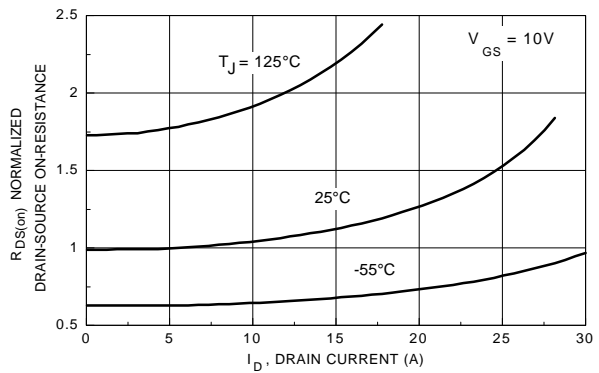

Figure 4. On-Resistance Variation with Drain Current and Temperature.

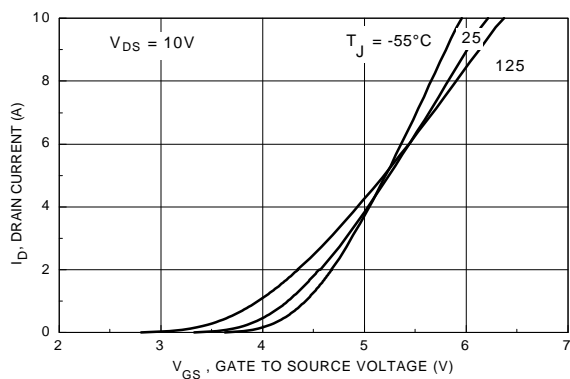

Figure 5. Transfer Characteristics.

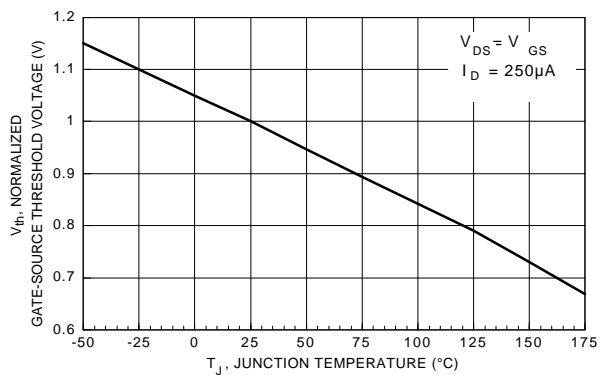

Figure 6. Gate Threshold Variation with Temperature.

Typical Electrical Characteristics (continued)

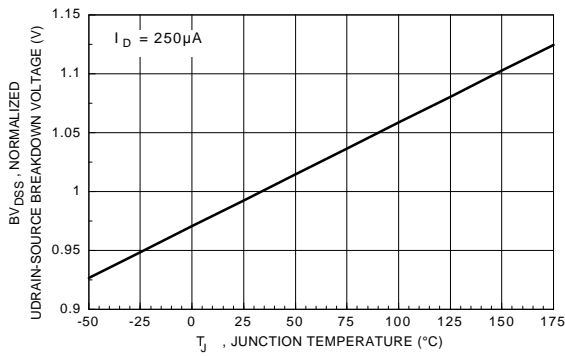

Figure 7. Breakdown Voltage Variation with Temperature.

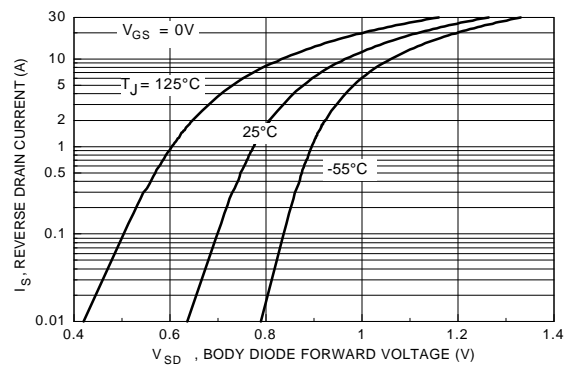

Figure 8. Body Diode Forward Voltage Variation with Current and Temperature.

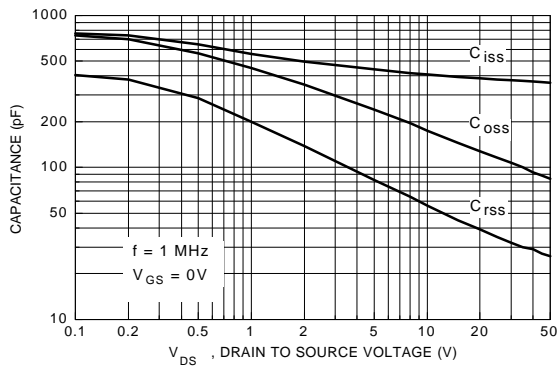

Figure 9. Capacitance Characteristics.

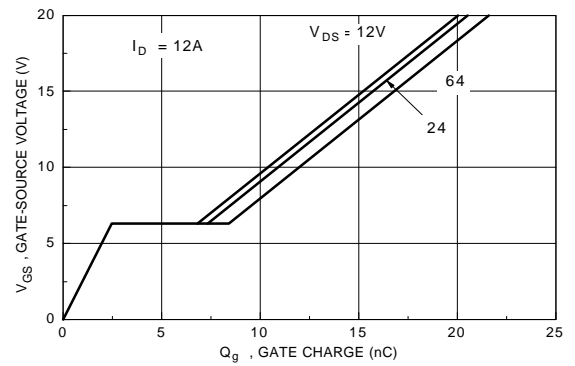

Figure 10. Gate Charge Characteristics.

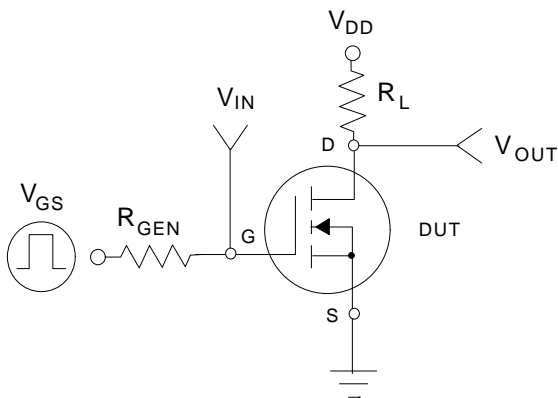

Figure 11. Switching Test Circuit.

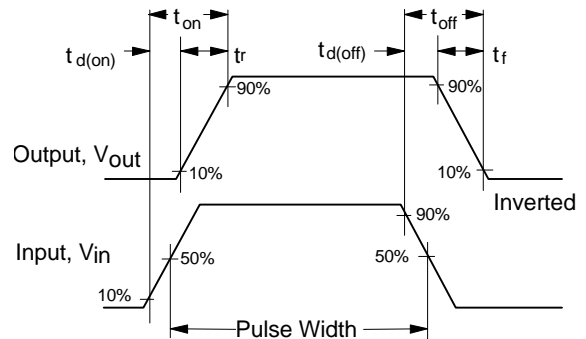

Figure 12. Switching Waveforms.

Typical Electrical Characteristics (continued)

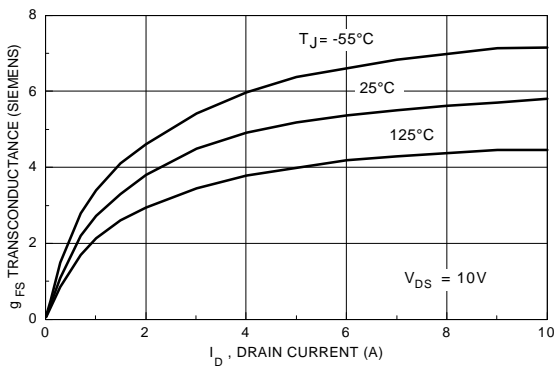

Figure 13. Transconductance Variation with Drain Current and Temperature.

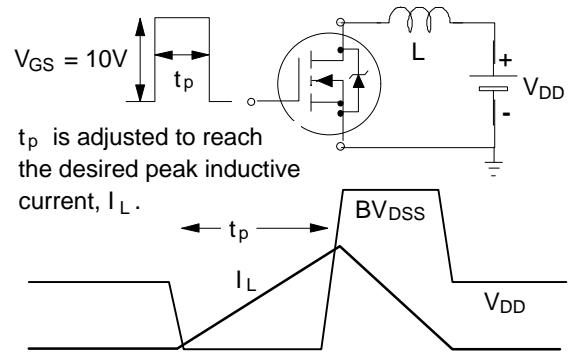

Figure 14. Unclamped Inductive Load Circuit and Waveforms.

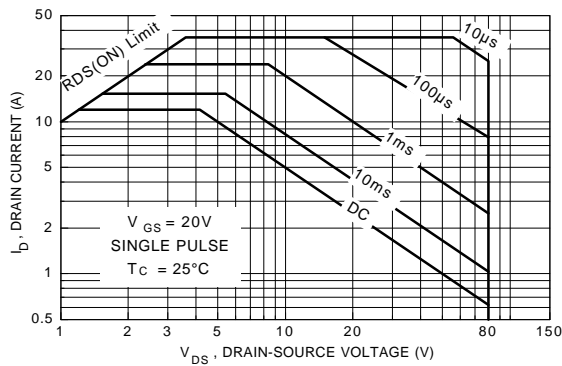

Figure 15. Maximum Safe Operating Area.

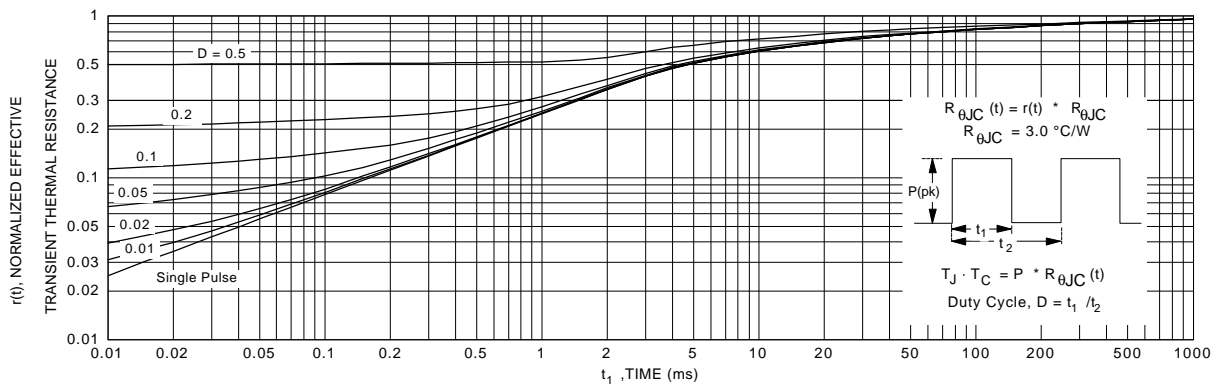

Figure 16. Transient Thermal Response Curve.