

NTGD3147F

Power MOSFET and Schottky Diode

-20 V, -2.5 A, P-Channel with Schottky Barrier Diode, TSOP-6

Features

- Fast Switching
- Low Gate Change
- Low $R_{DS(on)}$
- Low V_F Schottky Diode
- Independently Connected Devices to Provide Design Flexibility
- This is a Pb-Free Device

Applications

- DC-DC Converters
- Portable Devices like PDA's, Cellular Phones, and Hard Drives

MAXIMUM RATINGS ($T_J = 25^\circ\text{C}$ unless otherwise noted)

Parameter		Symbol	Value	Unit	
Drain-to-Source Voltage		V_{DSS}	-20	V	
Gate-to-Source Voltage		V_{GS}	± 12	V	
Continuous Drain Current (Note 1)	Steady State	I_D	$T_A = 25^\circ\text{C}$ $T_A = 85^\circ\text{C}$	-2.2 -1.6	A
	$t \leq 5$ s		$T_A = 25^\circ\text{C}$	-2.5	
Power Dissipation (Note 1)	Steady State	P_D	$T_A = 25^\circ\text{C}$	1.0	W
	$t \leq 5$ s			1.3	
Pulsed Drain Current		I_{DM}	-7.5	A	
Operating Junction and Storage Temperature		T_J, T_{STG}	-25 to 150	$^\circ\text{C}$	
Source Current (Body Diode)		I_S	-0.8	A	
Lead Temperature for Soldering Purposes (1/8" from case for 10 s)		T_L	260	$^\circ\text{C}$	

SCHOTTKY MAXIMUM RATINGS ($T_J = 25^\circ\text{C}$ unless otherwise stated)

Parameter	Symbol	Value	Unit
Peak Repetitive Reverse Voltage	V_{RRM}	20	V
DC Blocking Voltage	V_R	20	V
Average Rectified Forward Current	I_F	1	A

THERMAL RESISTANCE RATINGS

Parameter	Symbol	Value	Unit
Junction-to-Ambient - Steady-State (Note 1)	$R_{\theta JA}$	125	$^\circ\text{C}/\text{W}$
Junction-to-Ambient - $t \leq 5$ s (Note 1)	$R_{\theta JA}$	100	$^\circ\text{C}/\text{W}$
Junction-to-Ambient Steady-State (Note 2)	$R_{\theta JA}$	235	$^\circ\text{C}/\text{W}$

Stresses exceeding Maximum Ratings may damage the device. Maximum Ratings are stress ratings only. Functional operation above the Recommended Operating Conditions is not implied. Extended exposure to stresses above the Recommended Operating Conditions may affect device reliability.

1. Surface Mounted on FR4 Board using 1 in sq pad size (Cu area = 1.127 in sq [2 oz] including traces).
2. Surface Mounted on FR4 Board using the minimum recommended pad size (Cu area = 30 mm² [2 oz] including traces).



ON Semiconductor®

<http://onsemi.com>

P-CHANNEL MOSFET

$V_{(BR)DSS}$	$R_{DS(on)}$ Max	I_D Max
-20 V	145 m Ω @ -4.5 V	-2.2 A
	200 m Ω @ -2.5 V	-1.6 A

SCHOTTKY DIODE

V_R Max	V_F Max	I_F Max
20 V	0.45 V	1.0 A

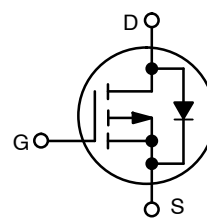

P-Channel MOSFET



Schottky Diode



TSOP-6
CASE 318G
STYLE 15

MARKING DIAGRAM

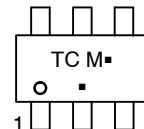

TC = Specific Device Code

M = Date Code

■ = Pb-Free Package

(Note: Microdot may be in either location)

PIN CONNECTION

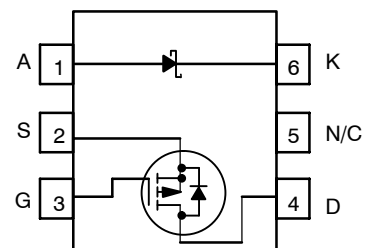

(Top View)

ORDERING INFORMATION

See detailed ordering and shipping information in the package dimensions section on page 6 of this data sheet.

NTGD3147F

MOSFET ELECTRICAL CHARACTERISTICS ($T_J = 25^\circ\text{C}$ unless otherwise noted)

Characteristic	Symbol	Test Condition	Min	Typ	Max	Unit
----------------	--------	----------------	-----	-----	-----	------

OFF CHARACTERISTICS

Drain-to-Source Breakdown Voltage	$V_{(BR)DSS}$	$V_{GS} = 0\text{ V}, I_D = 250\ \mu\text{A}$	-20			V
Drain-to-Source Breakdown Voltage Temperature Coefficient	$V_{(BR)DSS}/T_J$			14.2		mV/°C
Zero Gate Voltage Drain Current	I_{DSS}	$V_{GS} = 0\text{ V}, V_{DS} = -16\text{ V}$			-1.0	μA
		$T_J = 25^\circ\text{C}$			-10	
Gate-to-Source Leakage Current	I_{GSS}	$V_{DS} = 0\text{ V}, V_{GS} = \pm 12\text{ V}$			± 100	nA

ON CHARACTERISTICS (Note 3)

Gate Threshold Voltage	$V_{GS(TH)}$	$V_{GS} = V_{DS}, I_D = -250\ \mu\text{A}$	-0.5	-0.95	-1.5	V
Gate Threshold Temperature Coefficient	$V_{GS(TH)}/T_J$			3.0		mV/°C
Drain-to-Source On Resistance	$R_{DS(on)}$	$V_{GS} = -4.5\text{ V}, I_D = -2.2\text{ A}$		90	145	m Ω
		$V_{GS} = -2.5\text{ V}, I_D = -1.6\text{ A}$		140	200	
Forward Transconductance	g_{FS}	$V_{DS} = -5.0\text{ V}, I_D = -2.2\text{ A}$		4.5		S

CHARGES, CAPACITANCES AND GATE RESISTANCE

Input Capacitance	C_{ISS}	$V_{GS} = 0\text{ V}, f = 1.0\text{ MHz}, V_{DS} = -10\text{ V}$		400		pF
Output Capacitance	C_{OSS}			75		
Reverse Transfer Capacitance	C_{RSS}			40		
Total Gate Charge	$Q_{G(TOT)}$	$V_{GS} = -4.5\text{ V}, V_{DS} = -10\text{ V}, I_D = -2.2\text{ A}$		3.8	5.5	nC
Threshold Gate Charge	$Q_{G(TH)}$			0.5		
Gate-to-Source Charge	Q_{GS}			0.9		
Gate-to-Drain Charge	Q_{GD}			1.0		

SWITCHING CHARACTERISTICS (Note 4)

Turn-On Delay Time	$t_{d(ON)}$	$V_{GS} = -4.5\text{ V}, V_{DS} = -10\text{ V}, I_D = -1.0\text{ A}, R_G = 6.0\ \Omega$		7.5		ns
Rise Time	t_r			6.2		
Turn-Off Delay Time	$t_{d(OFF)}$			14.5		
Fall Time	t_f			18.4		

DRAIN-TO-SOURCE CHARACTERISTICS

Forward Diode Voltage	V_{SD}	$V_{GS} = 0\text{ V}, I_D = -0.8\text{ A}$	$T_J = 25^\circ\text{C}$		-0.8	1.2	V
Reverse Recovery Time	t_{RR}	$V_{GS} = 0\text{ V}, dI_S/dt = 100\text{ A}/\mu\text{s}, I_S = -0.8\text{ A}$			12		ns
Charge Time	T_a				8.0		
Discharge Time	T_b				4.0		
Reverse Recovery Time	Q_{RR}				4.0		nC

3. Pulse Test: pulse width $\leq 300\ \mu\text{s}$, duty cycle $\leq 2\%$.

4. Switching characteristics are independent of operating junction temperatures.

NTGD3147F

SCHOTTKY DIODE ELECTRICAL CHARACTERISTICS ($T_J = 25^\circ\text{C}$ unless otherwise noted)

Parameter	Symbol	Test Conditions	Min	Typ	Max	Unit
Maximum Instantaneous Forward Voltage	V_F	$I_F = 0.5 \text{ A}$		0.32	0.4	V
		$I_F = 1.0 \text{ A}$		0.36	0.45	
Maximum Instantaneous Reverse Current	I_R	$V_R = 10 \text{ V}$		0.04	1.0	mA
		$V_R = 20 \text{ V}$		0.21	5.0	

SCHOTTKY DIODE ELECTRICAL CHARACTERISTICS ($T_J = 75^\circ\text{C}$ unless otherwise noted)

Parameter	Symbol	Test Conditions	Min	Typ	Max	Unit
Maximum Instantaneous Forward Voltage	V_F	$I_F = 0.5 \text{ A}$		0.27		V
		$I_F = 1.0 \text{ A}$		0.31		
Maximum Instantaneous Reverse Current	I_R	$V_R = 10 \text{ V}$		0.77		mA
		$V_R = 20 \text{ V}$		2.65		

SCHOTTKY DIODE ELECTRICAL CHARACTERISTICS ($T_J = 125^\circ\text{C}$ unless otherwise noted)

Parameter	Symbol	Test Conditions	Min	Typ	Max	Unit
Maximum Instantaneous Forward Voltage	V_F	$I_F = 0.5 \text{ A}$		0.22		V
		$I_F = 1.0 \text{ A}$		0.27		
Maximum Instantaneous Reverse Current	I_R	$V_R = 10 \text{ V}$		8.75		mA
		$V_R = 20 \text{ V}$		37.37		

TYPICAL PERFORMANCE CHARACTERISTICS

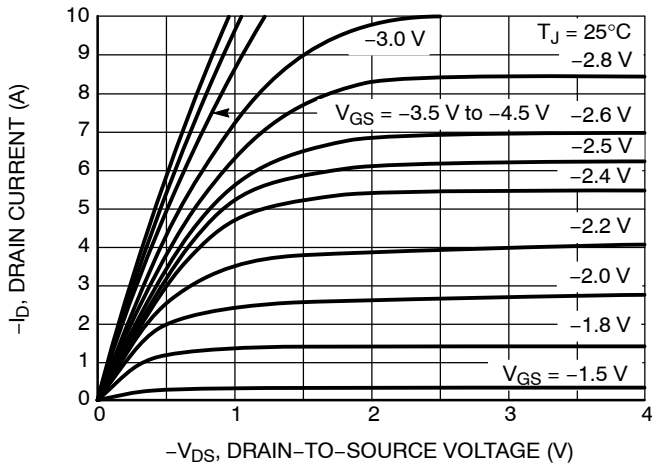

Figure 1. On-Region Characteristics

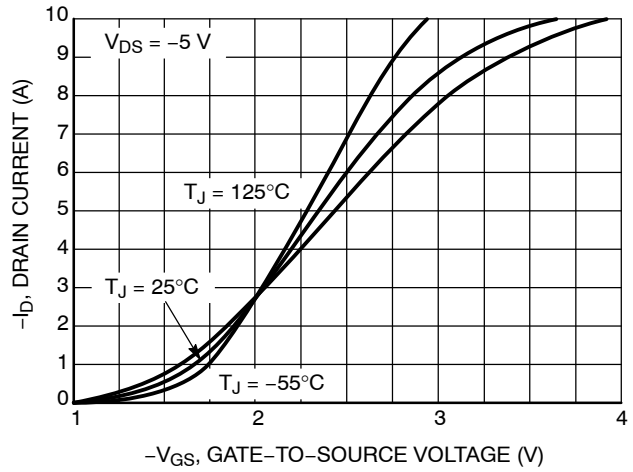

Figure 2. Transfer Characteristics

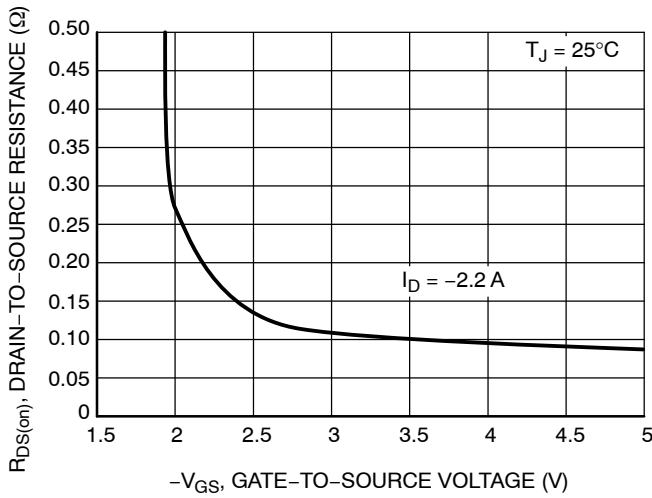

Figure 3. On-Resistance versus Gate-to-Source Voltage

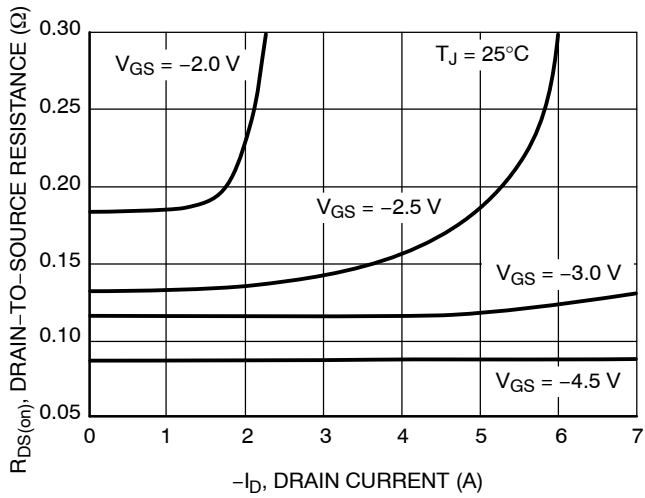

Figure 4. On-Resistance versus Drain Current and Gate Voltage

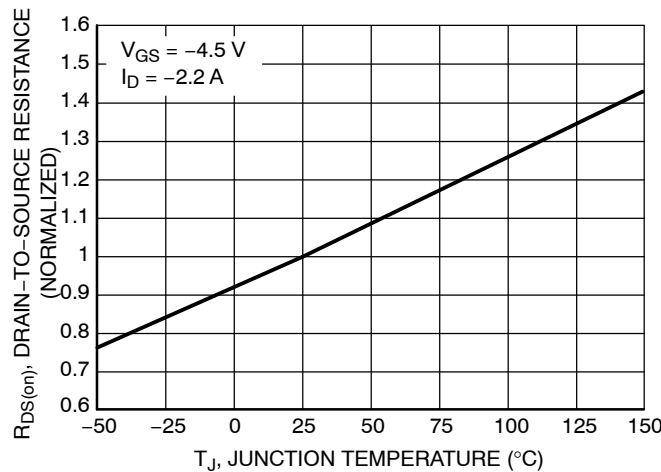

Figure 5. On-Resistance Variation with Temperature

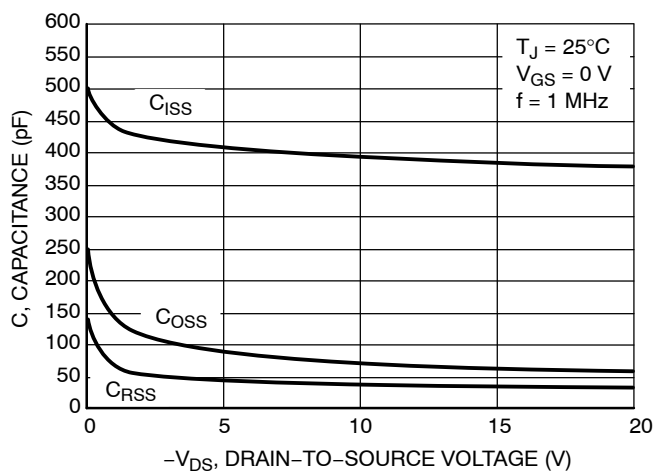

Figure 6. Capacitance Variation

TYPICAL PERFORMANCE CHARACTERISTICS

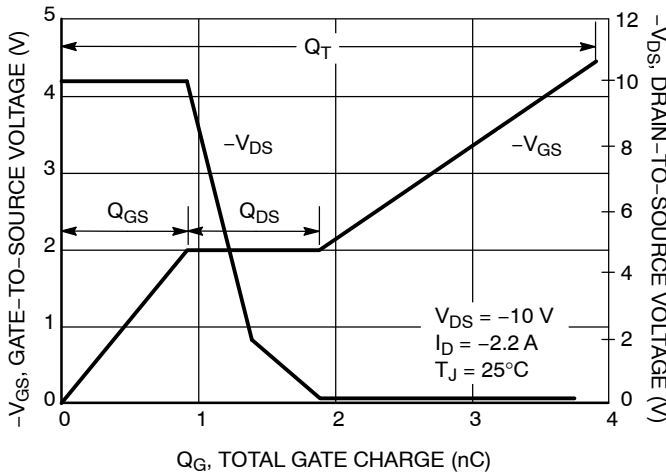

Figure 7. Gate-to-Source and Drain-to-Source Voltage versus Total Charge

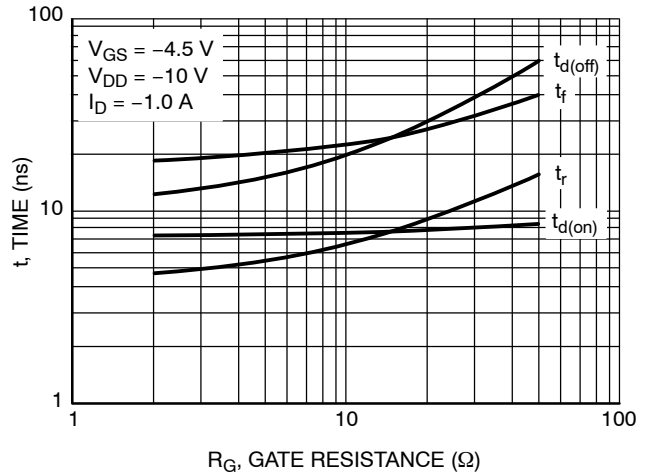

Figure 8. Resistive Switching Time Variation versus Gate Resistance

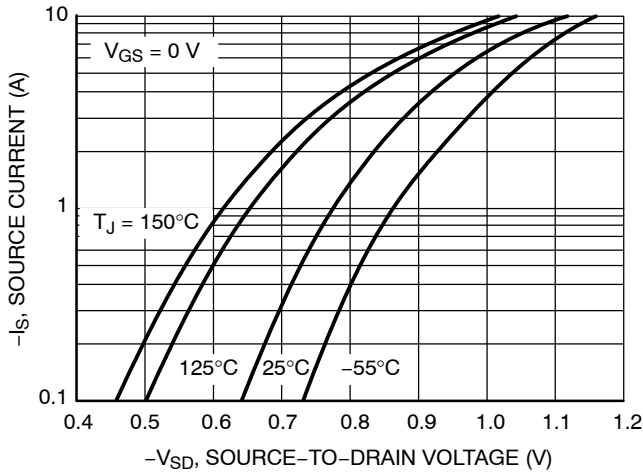

Figure 9. Diode Forward Voltage versus Current

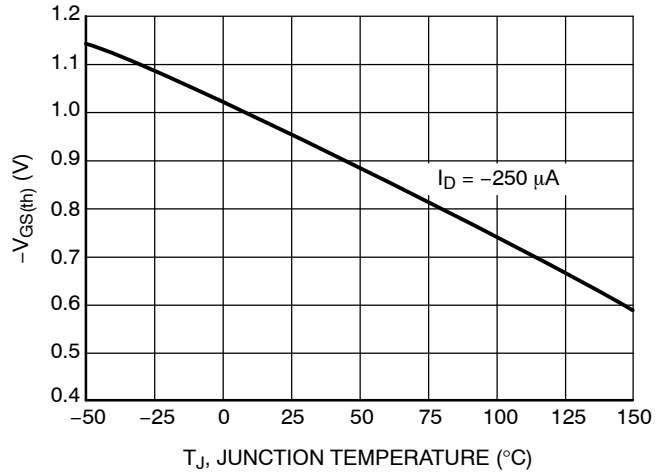

Figure 10. Threshold Voltage

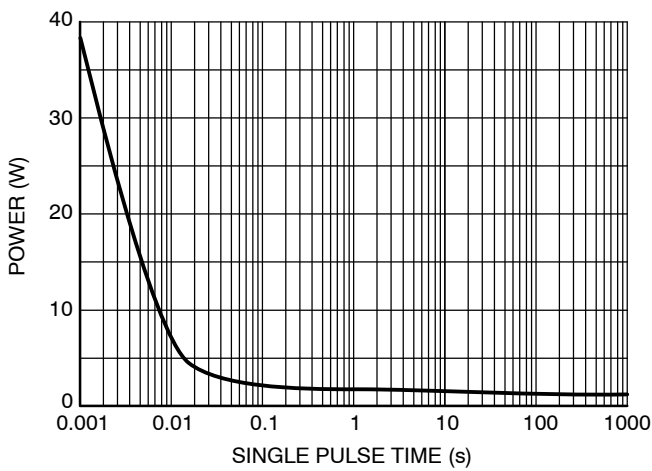

Figure 11. Single Pulse Maximum Power Dissipation

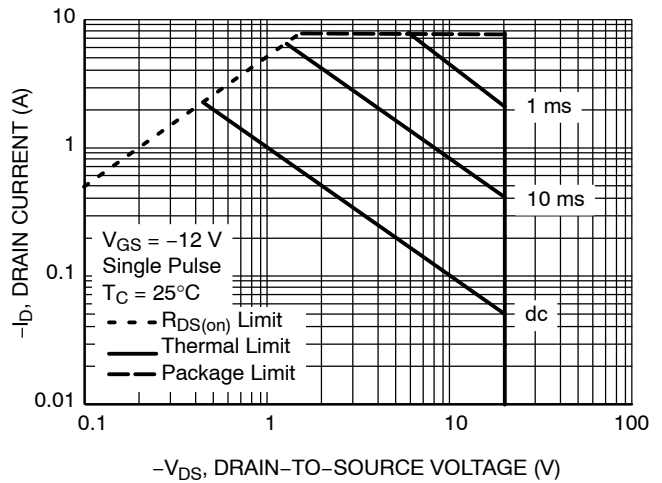

Figure 12. Maximum Rated Forward Biased Safe Operating Area

NTGD3147F

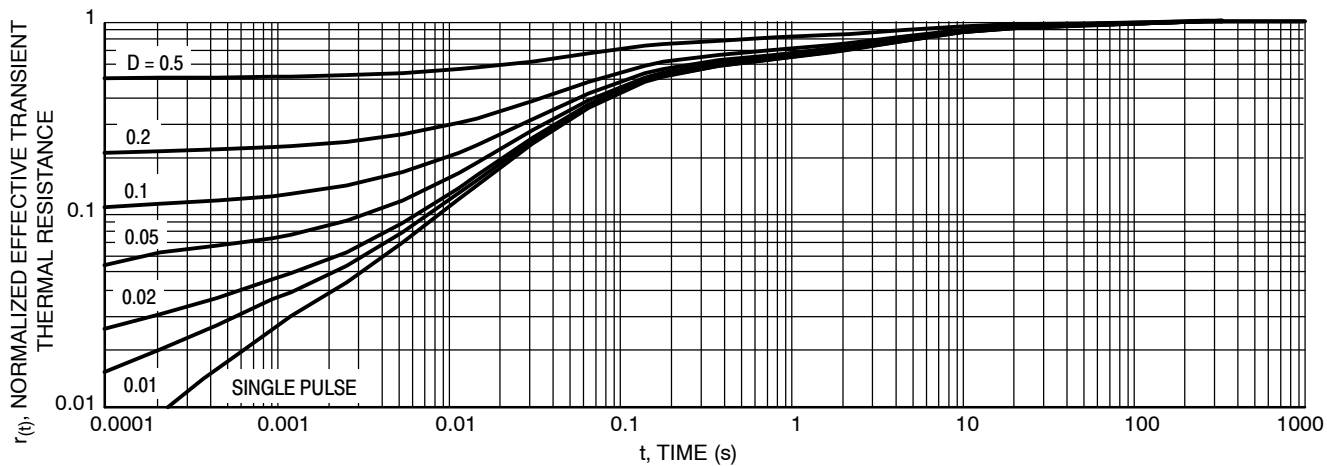

Figure 13. Thermal Response

TYPICAL SCHOTTKY CHARACTERISTICS

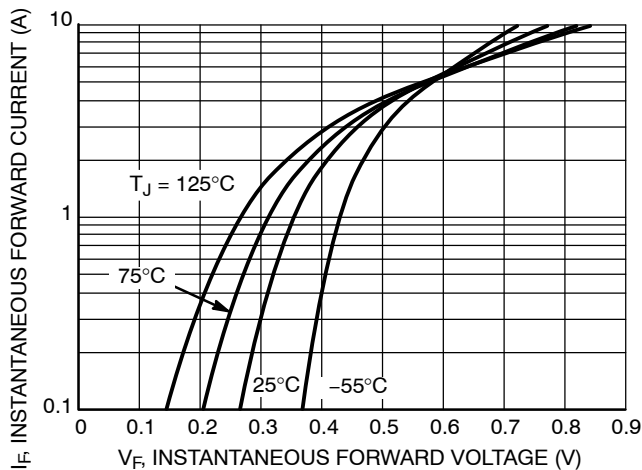

Figure 14. Typical Forward Voltage

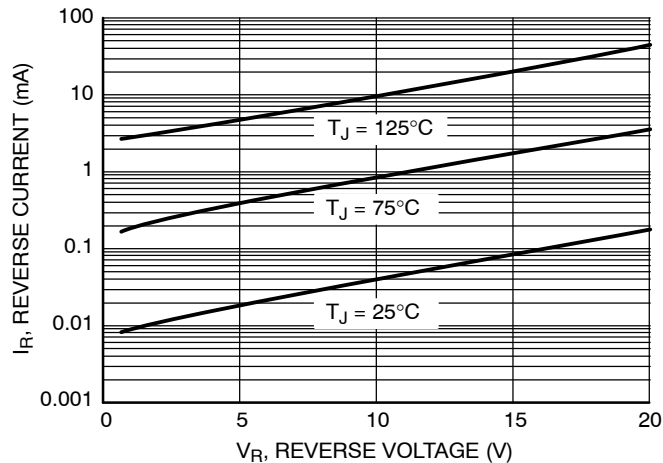

Figure 15. Typical Reverse Current

ORDERING INFORMATION

Device	Package	Shipping [†]
NTGD3147FT1G	TSOP-6 (Pb-Free)	3000 / Tape & Reel

[†]For information on tape and reel specifications, including part orientation and tape sizes, please refer to our Tape and Reel Packaging Specifications Brochure, BRD8011/D.

NTGD3147F

PACKAGE DIMENSIONS

TSOP-6
CASE 318G-02
ISSUE S

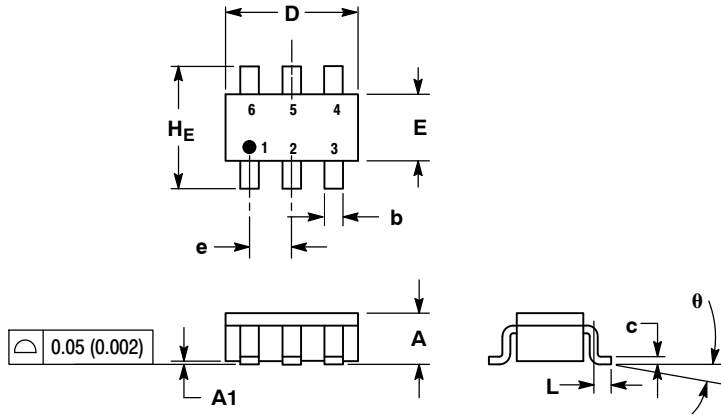

NOTES:

1. DIMENSIONING AND TOLERANCING PER ANSI Y14.5M, 1982.
2. CONTROLLING DIMENSION: MILLIMETER.
3. MAXIMUM LEAD THICKNESS INCLUDES LEAD FINISH THICKNESS. MINIMUM LEAD THICKNESS IS THE MINIMUM THICKNESS OF BASE MATERIAL.
4. DIMENSIONS A AND B DO NOT INCLUDE MOLD FLASH, PROTRUSIONS, OR GATE BURRS.

DIM	MILLIMETERS			INCHES		
	MIN	NOM	MAX	MIN	NOM	MAX
A	0.90	1.00	1.10	0.035	0.039	0.043
A1	0.01	0.06	0.10	0.001	0.002	0.004
b	0.25	0.38	0.50	0.010	0.014	0.020
c	0.10	0.18	0.26	0.004	0.007	0.010
D	2.90	3.00	3.10	0.114	0.118	0.122
E	1.30	1.50	1.70	0.051	0.059	0.067
e	0.85	0.95	1.05	0.034	0.037	0.041
L	0.20	0.40	0.60	0.008	0.016	0.024
HE	2.50	2.75	3.00	0.099	0.108	0.118
θ	0°	-	10°	0°	-	10°

STYLE 15:

- PIN 1: ANODE
2: SOURCE
3: GATE
4: DRAIN
5: N/C
6: CATHODE

SOLDERING FOOTPRINT*

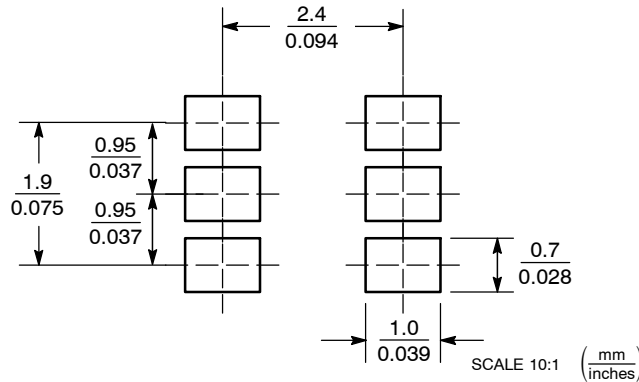

*For additional information on our Pb-Free strategy and soldering details, please download the ON Semiconductor Soldering and Mounting Techniques Reference Manual, SOLDERRM/D.

ON Semiconductor and are registered trademarks of Semiconductor Components Industries, LLC (SCILLC). SCILLC reserves the right to make changes without further notice to any products herein. SCILLC makes no warranty, representation or guarantee regarding the suitability of its products for any particular purpose, nor does SCILLC assume any liability arising out of the application or use of any product or circuit, and specifically disclaims any and all liability, including without limitation special, consequential or incidental damages. "Typical" parameters which may be provided in SCILLC data sheets and/or specifications can and do vary in different applications and actual performance may vary over time. All operating parameters, including "Typicals" must be validated for each customer application by customer's technical experts. SCILLC does not convey any license under its patent rights nor the rights of others. SCILLC products are not designed, intended, or authorized for use as components in systems intended for surgical implant into the body, or other applications intended to support or sustain life, or for any other application in which the failure of the SCILLC product could create a situation where personal injury or death may occur. Should Buyer purchase or use SCILLC products for any such unintended or unauthorized application, Buyer shall indemnify and hold SCILLC and its officers, employees, subsidiaries, affiliates, and distributors harmless against all claims, costs, damages, and expenses, and reasonable attorney fees arising out of, directly or indirectly, any claim of personal injury or death associated with such unintended or unauthorized use, even if such claim alleges that SCILLC was negligent regarding the design or manufacture of the part. SCILLC is an Equal Opportunity/Affirmative Action Employer. This literature is subject to all applicable copyright laws and is not for resale in any manner.

PUBLICATION ORDERING INFORMATION

LITERATURE FULFILLMENT:

Literature Distribution Center for ON Semiconductor
P.O. Box 5163, Denver, Colorado 80217 USA
Phone: 303-675-2175 or 800-344-3860 Toll Free USA/Canada
Fax: 303-675-2176 or 800-344-3867 Toll Free USA/Canada
Email: orderlit@onsemi.com

N. American Technical Support: 800-282-9855 Toll Free
USA/Canada
Europe, Middle East and Africa Technical Support:
Phone: 421 33 790 2910
Japan Customer Focus Center
Phone: 81-3-5773-3850

ON Semiconductor Website: www.onsemi.com

Order Literature: <http://www.onsemi.com/orderlit>

For additional information, please contact your local Sales Representative

NTGD3147F/D