

AO6706

N-Channel Enhancement Mode Field Effect Transistor with Schottky Diode

General Description

The AO6706 uses advanced trench technology to provide excellent $R_{DS(ON)}$ and low gate charge. A Schottky diode is provided to facilitate the implementation of a bidirectional blocking switch, or for DC-DC conversion applications. Standard Product AO6706 is Pb-free (meets ROHS & Sony 259 specifications). AO6706L is a Green Product ordering option. AO6706 and AO6706L are electrically identical.

Features

$V_{DS} (V) = 30V$
 $I_D = 3.6A (V_{GS} = 10V)$
 $R_{DS(ON)} < 65m\Omega (V_{GS} = 10V)$
 $R_{DS(ON)} < 75m\Omega (V_{GS} = 4.5V)$
 $R_{DS(ON)} < 160m\Omega (V_{GS} = 2.5V)$
SCHOTTKY
 $V_{DS} (V) = 20V, I_F = 1A, V_F < 0.5V @ 0.5A$

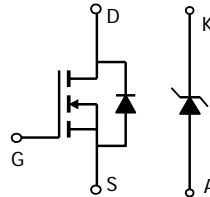
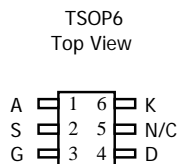

Absolute Maximum Ratings $T_A=25^\circ C$ unless otherwise noted

Parameter	Symbol	MOSFET	Schottky	Units
Drain-Source Voltage	V_{DS}	30		V
Gate-Source Voltage	V_{GS}	± 12		V
Continuous Drain Current ^A	I_D	$T_A=25^\circ C$	3.3	A
		$T_A=70^\circ C$	2.6	
Pulsed Drain Current ^B	I_{DM}	10		
Schottky reverse voltage	V_{KA}		20	V
Continuous Forward Current ^A	I_F	$T_A=25^\circ C$	2	A
		$T_A=70^\circ C$	1	
Pulsed Forward Current ^B	I_{FM}		10	
Power Dissipation	P_D	$T_A=25^\circ C$	1.15	W
		$T_A=70^\circ C$	0.7	
Junction and Storage Temperature Range	T_J, T_{STG}	-55 to 150	-55 to 150	$^\circ C$

Parameter: Thermal Characteristics MOSFET	Symbol	Typ	Max	Units
Maximum Junction-to-Ambient ^A $t \leq 10s$	$R_{\theta JA}$	80.3	110	$^\circ C/W$
Maximum Junction-to-Ambient ^A Steady-State		117	150	
Maximum Junction-to-Lead ^C Steady-State	$R_{\theta JL}$	43	80	
Thermal Characteristics Schottky				
Maximum Junction-to-Ambient ^A $t \leq 10s$	$R_{\theta JA}$	109.4	135	$^\circ C/W$
Maximum Junction-to-Ambient ^A Steady-State		136.5	175	
Maximum Junction-to-Lead ^C Steady-State	$R_{\theta JL}$	58.5	80	

Electrical Characteristics (T_J=25°C unless otherwise noted)

Symbol	Parameter	Conditions	Min	Typ	Max	Units
STATIC PARAMETERS						
BV _{DSS}	Drain-Source Breakdown Voltage	I _D =250μA, V _{GS} =0V	30			V
I _{DSS}	Zero Gate Voltage Drain Current	V _{DS} =24V, V _{GS} =0V T _J =55°C			1 5	μA
I _{GSS}	Gate-Body leakage current	V _{DS} =0V, V _{GS} =±12V			100	nA
V _{GS(th)}	Gate Threshold Voltage	V _{DS} =V _{GS} , I _D =250μA	1	1.4	1.8	V
I _{D(ON)}	On state drain current	V _{GS} =4.5V, V _{DS} =5V	10			A
R _{DS(ON)}	Static Drain-Source On-Resistance	V _{GS} =10V, I _D =3.3A T _J =125°C		44 64	65 90	mΩ
		V _{GS} =4.5V, I _D =3.0A		53	75	
		V _{GS} =2.5V, I _D =1A		106	160	mΩ
g _{FS}	Forward Transconductance	V _{DS} =5V, I _D =3.3A		11.7		S
V _{SD}	Diode Forward Voltage	I _S =1A, V _{GS} =0V		0.81	1	V
I _S	Maximum Body-Diode Continuous Current				2.5	A
DYNAMIC PARAMETERS						
C _{iss}	Input Capacitance	V _{GS} =0V, V _{DS} =15V, f=1MHz		226	270	pF
C _{oss}	Output Capacitance			39		pF
C _{rss}	Reverse Transfer Capacitance			29		pF
R _g	Gate resistance	V _{GS} =0V, V _{DS} =0V, f=1MHz		1.4	4	Ω
SWITCHING PARAMETERS						
Q _g	Total Gate Charge	V _{GS} =4.5V, V _{DS} =15V, I _D =3.3A		3	3.6	nC
Q _{gs}	Gate Source Charge			1.4		nC
Q _{gd}	Gate Drain Charge			0.55		nC
t _{D(on)}	Turn-On DelayTime	V _{GS} =10V, V _{DS} =15V, R _L =4.7Ω, R _{GEN} =6Ω		2.6		ns
t _r	Turn-On Rise Time			3.2		ns
t _{D(off)}	Turn-Off DelayTime			14.5		ns
t _f	Turn-Off Fall Time			2.1		ns
t _{rr}	Body Diode Reverse Recovery Time		I _F =3.3A, di/dt=100A/μs		10.2	13
Q _{rr}	Body Diode Reverse Recovery Charge	I _F =3.3A, di/dt=100A/μs		3.8		nC
SCHOTTKY PARAMETERS						
V _F	Forward Voltage Drop	I _F =0.5A		0.39	0.5	V
I _{rm}	Maximum reverse leakage current	V _R =16V			0.1	mA
		V _R =16V, T _J =125°C			20	
C _T	Junction Capacitance	V _R =10V		34		pF
t _{rr}	Schottky Reverse Recovery Time	I _F =1A, di/dt=100A/μs		5.2	10	ns
Q _{rr}	Schottky Reverse Recovery Charge	I _F =1A, di/dt=100A/μs		0.8		nC

A: The value of R_{thJA} is measured with the device mounted on 1 in² FR-4 board with 2oz. Copper, in a still air environment with T_A=25°C. The value in any a given application depends on the user's specific board design. The current rating is based on the t ≤ 10s thermal resistance rating.

B: Repetitive rating, pulse width limited by junction temperature.

C: The R_{thJA} is the sum of the thermal impedance from junction to lead R_{thJL} and lead to ambient.

D: The static characteristics in Figures 1 to 6 are obtained using 80μs pulses, duty cycle 0.5% max.

E: These tests are performed with the device mounted on 1 in² FR-4 board with 2oz. Copper, in a still air environment with T_A=25°C. The SOA curve provides a single pulse rating. Rev2: August 2005

THIS PRODUCT HAS BEEN DESIGNED AND QUALIFIED FOR THE CONSUMER MARKET. APPLICATIONS OR USES AS CRITICAL COMPONENTS IN LIFE SUPPORT DEVICES OR SYSTEMS ARE NOT AUTHORIZED. AOS DOES NOT ASSUME ANY LIABILITY ARISING OUT OF SUCH APPLICATIONS OR USES OF ITS PRODUCTS. AOS RESERVES THE RIGHT TO IMPROVE PRODUCT DESIGN, FUNCTIONS AND RELIABILITY WITHOUT NOTICE.

TYPICAL ELECTRICAL AND THERMAL CHARACTERISTICS

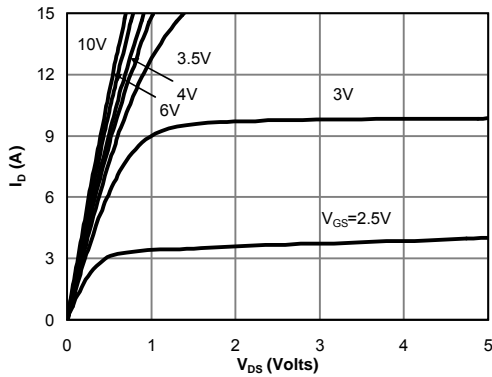

Fig 1: On-Region Characteristics

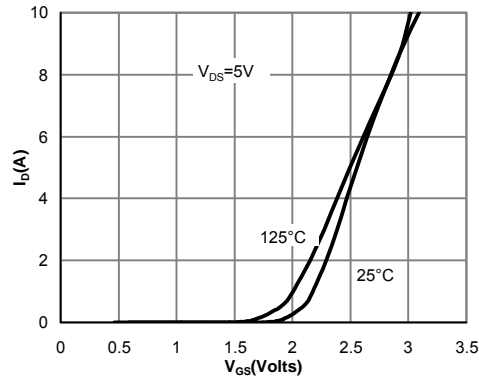

Figure 2: Transfer Characteristics

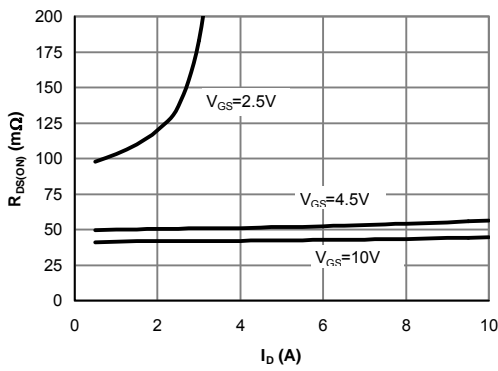

Figure 3: On-Resistance vs. Drain Current and Gate Voltage

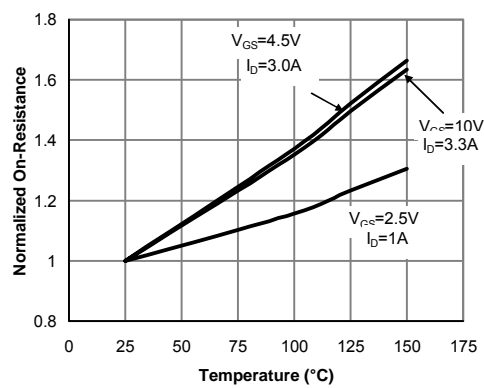

Figure 4: On-Resistance vs. Junction Temperature

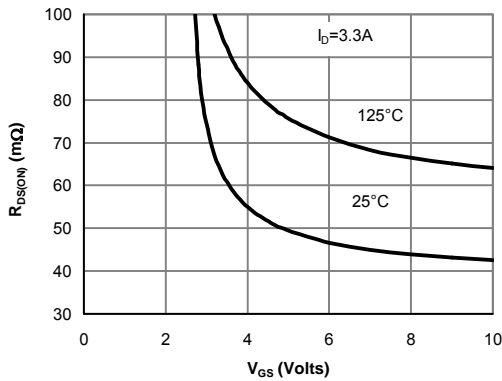

Figure 5: On-Resistance vs. Gate-Source Voltage

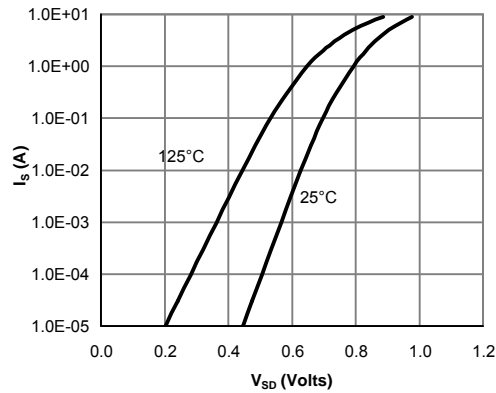

Figure 6: Body-Diode Characteristics

TYPICAL ELECTRICAL AND THERMAL CHARACTERISTICS

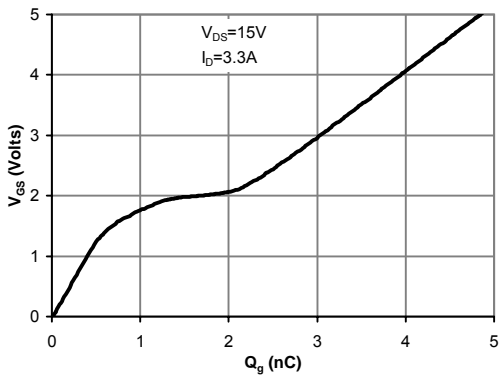

Figure 7: Gate-Charge Characteristics

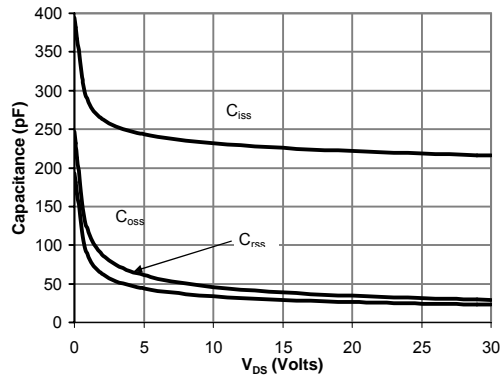

Figure 8: Capacitance Characteristics

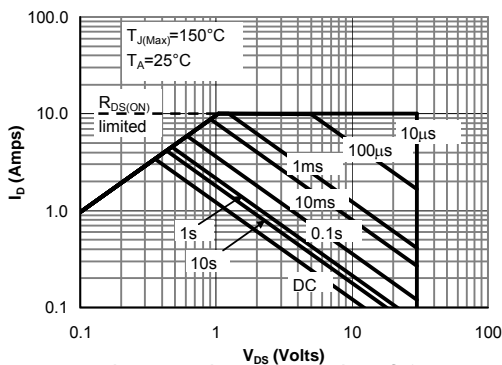

Figure 9: Maximum Forward Biased Safe Operating Area (Note E)

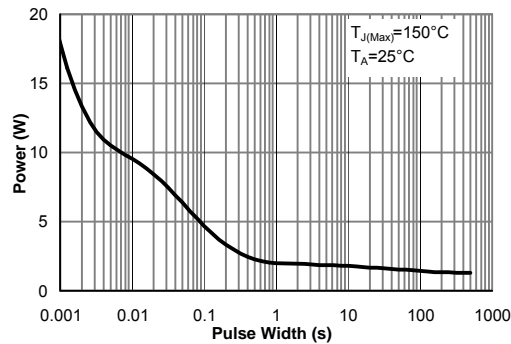

Figure 10: Single Pulse Power Rating Junction-to-Ambient (Note E)

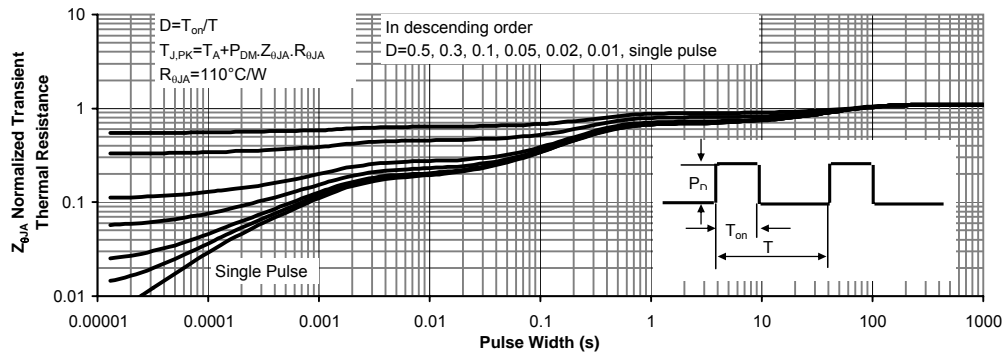

Figure 11: Normalized Maximum Transient Thermal Impedance

TYPICAL ELECTRICAL AND THERMAL CHARACTERISTICS: SCHOTTKY

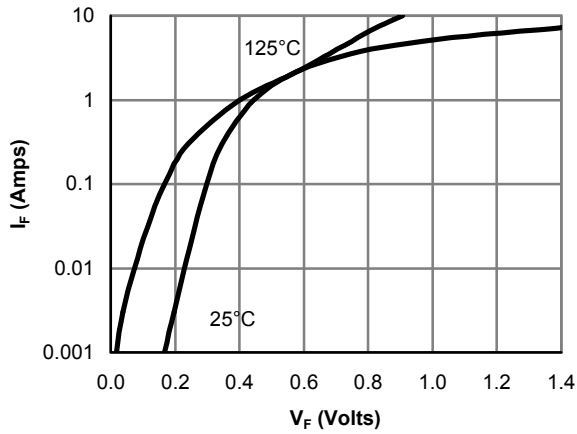

Figure 12: Schottky Forward Characteristics

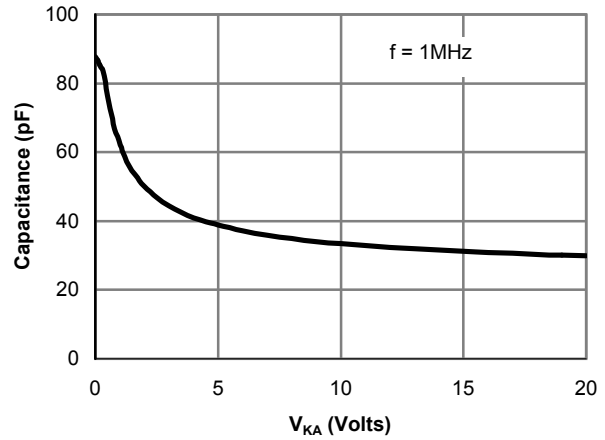

Figure 13: Schottky Capacitance Characteristics

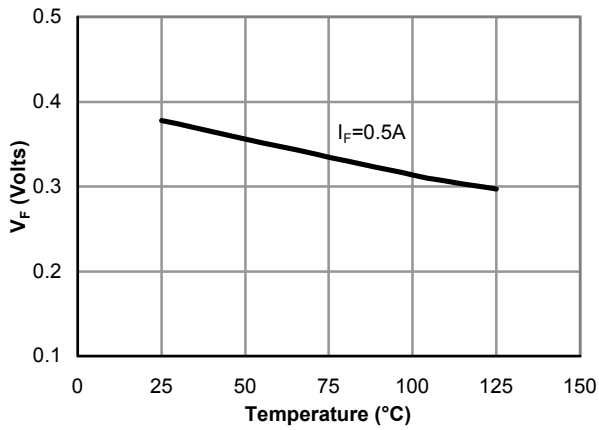

Figure 14: Schottky Forward Drop vs. Junction Temperature

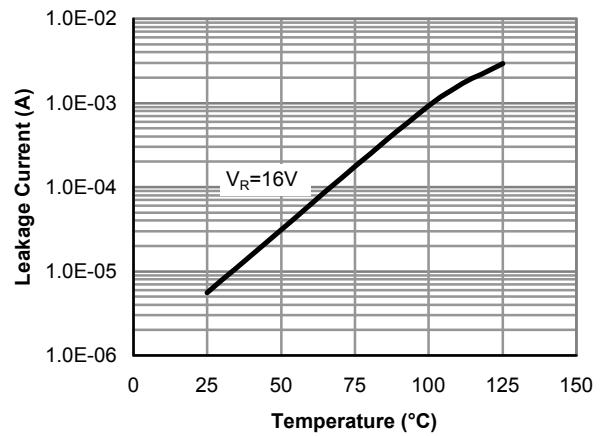

Figure 15: Schottky Leakage current vs. Junction Temperature

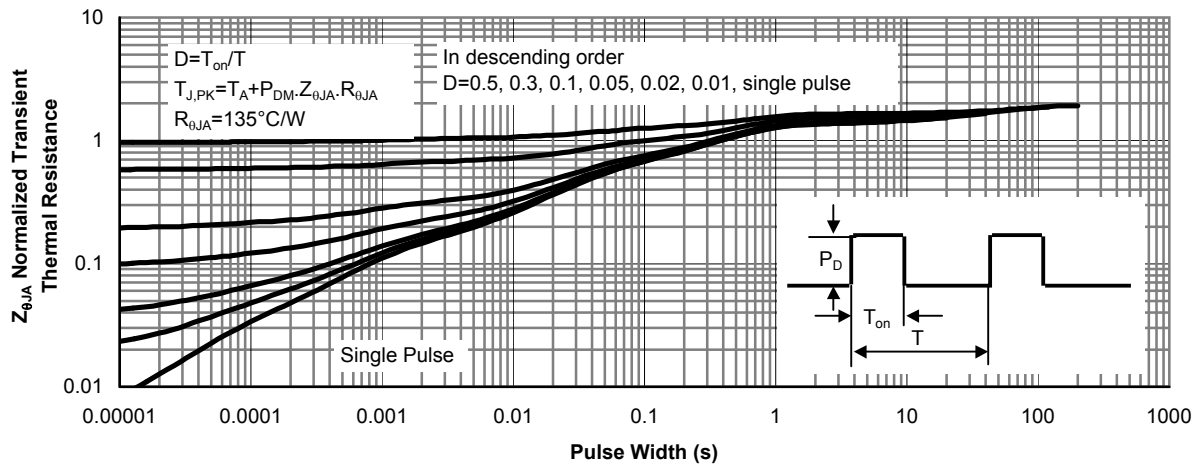
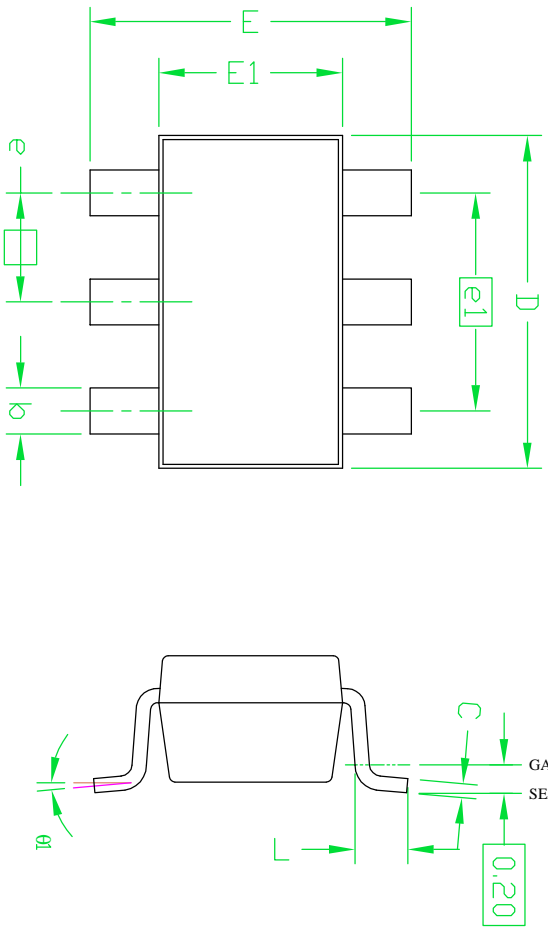
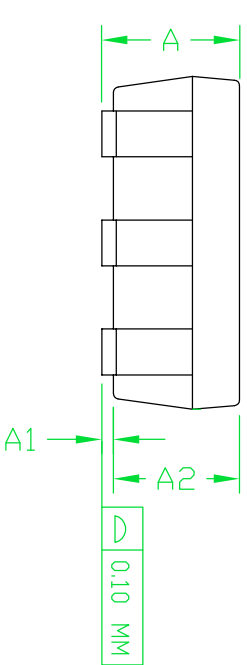

Figure 15: Schottky Normalized Maximum Transient Thermal Impedance



- NOTE
1. PACKAGE BODY SIZES EXCLUDE MOLD FLASH AND GATE BURRS
 2. DIMENSION "L" IS MEASURED IN GAGE PLANE
 3. COPLANARITY : 0.1000 mm
 4. TOLERANCE ± 0.1000 mm(4 mil) UNLESS OTHERWISE SPECIFIED
 5. FOLLOWED FROM JEDEC MO-178C & MO-193C
 6. CONTROLLING DIMENSIONS IS MILLIMETER. CONVERTED INCH DIMENSIONS ARE NOT NECESSARILY EXACT.



RECOMMENDED LAND PATTERN

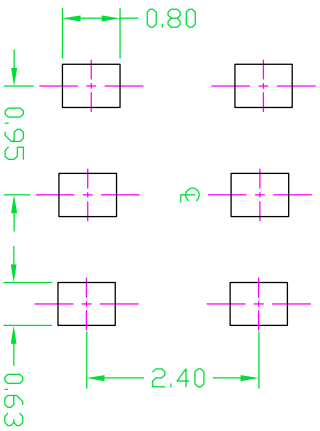

SYMBOLS	DIMENSIONS IN MILLIMETERS			DIMENSIONS IN INCHES		
	MIN	NOM	MAX	MIN	NOM	MAX
A	0.9	---	1.25	0.035	---	0.049
A1	0.00	---	0.15	0.00	---	0.006
A2	0.70	1.10	1.20	0.028	0.043	0.047
b	0.30	0.40	0.50	0.012	0.016	0.020
C	0.08	0.13	0.20	0.003	0.005	0.008
D	2.70	2.90	3.10	0.106	0.114	0.122
E	2.50	2.80	3.10	0.098	0.110	0.122
E1	1.50	1.60	1.70	0.059	0.063	0.067
e	0.95 BSC.			0.037BSC.		
e1	1.90 BSC.			0.075 BSC.		
L	0.30	---	0.60	0.012	---	0.024
theta1	0°	---	8°	0°	---	8°

UNIT: mm

UNLESS OTHERWISE SPECIFIED DIMENSIONS ARE IN INCHES DECIMAL XX ± XXX ± XXXX ± INTERPRET DIM AND TOL PER ASME Y14.5M - 1994	ANGULAR ±		
		THIRD ANGLE PROJECTION	
Document No.	PD-00002	Version	rev B
Title	TSOP-6 PACKAGE OUTLINE		



Document No.	PD-00252
Version	rev B
Title	AO6706 Marking Description

TSOP-6 PACKAGE MARKING DESCRIPTION

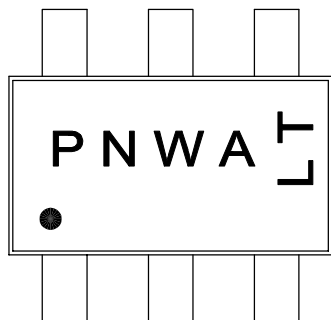

Standard product

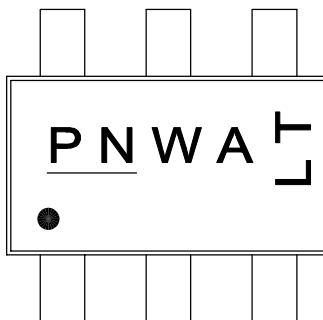

Green product

NOTE:

P - Package and product type.
N - Last digital of product number.
W - Week code
A - Foundry location code
LT - Assembly lot code.

PART NO.	DESCRIPTION	CODE (PN)
AO6706	Standard product	G6
AO6706L	Green product	<u>G6</u>



TSOP-6 Carrier Tape

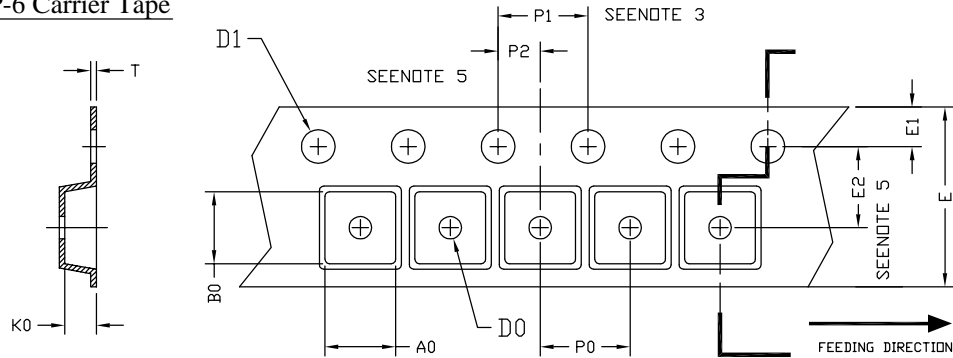

UNIT: MM

PACKAGE	A0	B0	K0	D0	D1	E	E1	E2	P0	P1	P2	T
SDT-23 (8 mm)	3.15 ±0.10	3.27 ±0.10	1.34 ±0.10	1.10 ±0.01	1.50 +0.10	8.00 ±0.20	1.75 ±0.10	3.50 ±0.05	4.00 ±0.10	4.00 ±0.10	2.00 ±0.10	0.25 ±0.05

TSOP-6 Reel

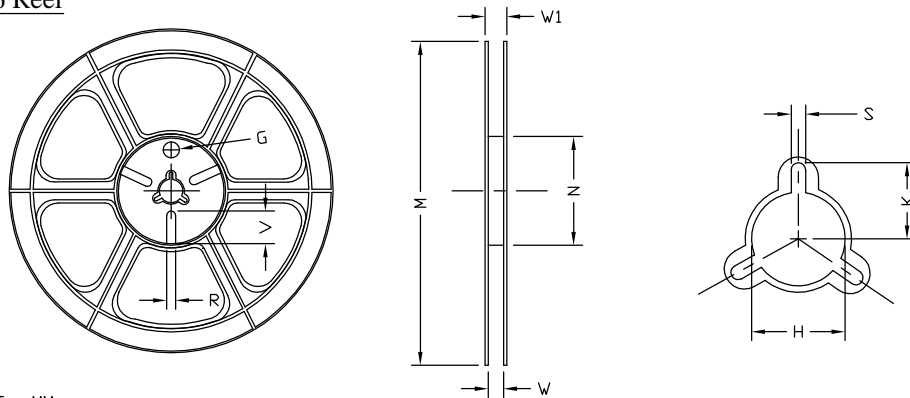

UNIT: MM

TAPE SIZE	REEL SIZE	M	N	W	W1	H	K	S	G	R	V
8 mm	ø180	ø180.00 ±0.50	ø60.50	9.00 ±0.30	11.40 ±1.00	ø13.00 +0.50 -0.20	10.60	2.00 ±0.50	ø9.00	5.00	18.00

TSOP-6 Tape

Leader / Trailer & Orientation

