

# MAU100 Series

1W, Miniature SIP, Single & Dual Output DC/DC Converters



## Key Features



- Efficiency up to 81%
- 1000VDC Isolation
- MTBF > 2,000,000 Hours
- Low Cost
- Input 5, 12, 15 and 24VDC
- Output 3.3, 5, 9, 12, 15,  $\pm 5$ ,  $\pm 9$ ,  $\pm 12$  and  $\pm 15$ VDC
- Temperature Performance  $-40^{\circ}\text{C}$  to  $+85^{\circ}\text{C}$
- UL 94V-0 Package Material
- Internal SMD Construction
- Industry Standard Pinout

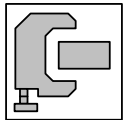

Low Profile

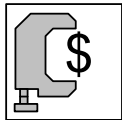

Low Cost

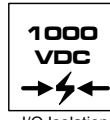

1000 VDC  
I/O Isolation

Minmax's MAU100 1W DC/DC's are specially designed to provide the optimum cost/benefit power solution in a miniature SIP package.

The series consists of 33 models with input voltages of 5V, 12V, 15V and 24VDC which offers standard output voltages of 3.3V, 5V, 9V, 12V, 15V,  $\pm 5$ V,  $\pm 9$ V,  $\pm 12$ V and  $\pm 15$ VDC for a wide choice.

The MAU100 series is an excellent selection for a variety of applications including distributed power systems, mixed analog/digital subsystems, portable test equipments, local power networks and battery backed systems.

## Absolute Maximum Ratings

Parameter	Min.	Max.	Unit	
Input Surge Voltage (1000 mS)	5VDC Input Models	-0.7	9	VDC
	12VDC Input Models	-0.7	18	VDC
	15VDC Input Models	-0.7	18	VDC
	24VDC Input Models	-0.7	30	VDC
Lead Temperature (1.5mm from case for 10 Sec.)	---	260	$^{\circ}\text{C}$	
Internal Power Dissipation	---	450	mW	

Exceeding the absolute maximum ratings of the unit could cause damage.  
These are not continuous operating ratings.

## Environmental Specifications

Parameter	Conditions	Min.	Max.	Unit
Operating Temperature	Ambient	-40	+85	$^{\circ}\text{C}$
Operating Temperature	Case	-40	+90	$^{\circ}\text{C}$
Storage Temperature		-40	+125	$^{\circ}\text{C}$
Humidity		---	95	%
Cooling	Free-Air Convection			

## Model Selection Guide

Model Number	Input Voltage	Output Voltage	Output Current		Input Current		Load Regulation	Efficiency
			Max.	Min.	@Max. Load	@No Load		@Max. Load
	VDC	VDC	mA	mA	mA (Typ.)	mA (Typ.)	% (Max.)	% (Typ.)
MAU101	5 (4.5 ~ 5.5)	3.3	260	5	235	30	10	73
MAU102		5	200	4	281		10	71
MAU103		9	110	2	260		8	76
MAU104		12	84	1.5	258		7	78
MAU105		15	67	1	258		7	78
MAU106		±5	±100	±2	278		10	72
MAU107		±9	±56	±1	262		8	77
MAU108		±12	±42	±0.8	258		7	78
MAU109		±15	±34	±0.7	258		7	79
MAU111	12 (10.8 ~ 13.2)	3.3	260	5	96	12	8	74
MAU112		5	200	4	114		8	73
MAU113		9	110	2	106		5	78
MAU114		12	84	1.5	105		5	80
MAU115		15	67	1	104		5	80
MAU116		±5	±100	±2	113		8	74
MAU117		±9	±56	±1	106		5	79
MAU118		±12	±42	±0.8	104		5	81
MAU119		±15	±34	±0.7	105		5	81
MAU121	24 (21.6 ~ 26.4)	3.3	260	5	49	7	8	73
MAU122		5	200	4	59		8	71
MAU123		9	110	2	54		5	76
MAU124		12	84	1.5	54		5	78
MAU125		15	67	1	53		5	79
MAU126		±5	±100	±2	58		8	72
MAU127		±9	±56	±1	55		5	76
MAU128		±12	±42	±0.8	53		5	79
MAU129		±15	±34	±0.7	53		5	80
MAU151	15 (13.5 ~ 16.5)	5	200	4	93	11	8	72
MAU152		12	84	1.5	85		5	79
MAU153		15	67	1	85		5	79
MAU154		±5	±100	±2	93		8	72
MAU155		±12	±42	±0.8	85		5	80
MAU156		±15	±34	±0.7	85		5	80

## Capacitive Load

Models by Vout	3.3V	5V	9V	12V	15V	±5V #	±9V #	±12V #	±15V #	Unit
Maximum Capacitive Load	220	220	220	220	220	100	100	100	100	µF

# For each output

## Input Fuse Selection Guide

5V Input Models	12V Input Models	15V Input Models	24V Input Models
500mA Slow – Blow Type	200mA Slow – Blow Type	150mA Slow – Blow Type	100mA Slow – Blow Type

## Input Specifications

Parameter	Model	Min.	Typ.	Max.	Unit
Input Voltage Range	5V Input Models	4.5	5	5.5	VDC
	12V Input Models	10.8	12	13.2	
	15V Input Models	13.5	15	16.5	
	24V Input Models	21.6	24	26.4	
Reverse Polarity Input Current	All Models	---	---	0.3	A
Input Filter		Internal Capacitor			

## Output Specifications

Parameter	Conditions	Min.	Typ.	Max.	Unit
Output Voltage Accuracy		---	$\pm 1.0$	$\pm 3.0$	%
Output Voltage Balance	Dual Output, Balanced Loads	---	$\pm 0.1$	$\pm 1.0$	%
Line Regulation	For Vin Change of 10%	---	$\pm 1.2$	$\pm 1.5$	%
Load Regulation	Io=20% to 100%	See Model Selection Guide			%
Ripple & Noise (20MHz)		---	50	75	mV P-P
Ripple & Noise (20MHz)	Over Line, Load & Temp.	---	---	150	mV P-P
Ripple & Noise (20MHz)		---	---	5	mV rms
Temperature Coefficient		---	$\pm 0.01$	$\pm 0.02$	%/°C
Output Short Circuit	0.5 Second Max.				

## General Specifications

Parameter	Conditions	Min.	Typ.	Max.	Unit
Isolation Voltage Rated	60 Seconds	1000	---	---	VDC
Isolation Voltage Test	Flash Tested for 1 Second	1100	---	---	VDC
Isolation Resistance	500VDC	1000	---	---	MΩ
Isolation Capacitance	100KHz, 1V	---	60	100	pF
Switching Frequency		70	100	120	KHz
MTBF	MIL-HDBK-217F @ 25°C, Ground Benign	2000	---	---	K Hours

### Notes:

1. Specifications typical at Ta=+25°C, resistive load, nominal input voltage, rated output current unless otherwise noted.
2. Ripple & Noise measurement bandwidth is 0–20 MHz.
3. These power converters require a minimum output loading to maintain specified regulation.
4. Operation under no-load conditions will not damage these modules; however, they may not meet all specifications listed.
5. All DC/DC converters should be externally fused at the front end for protection.
6. Other input and output voltage may be available, please contact factory.
7. Specifications subject to change without notice.

## Block Diagram

### Single Output

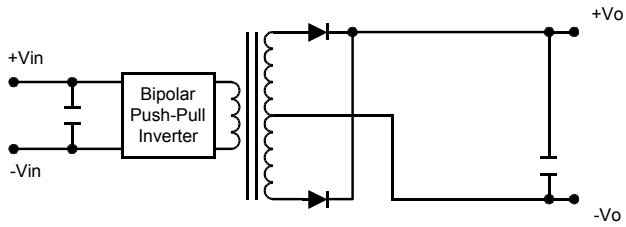

### Dual Output

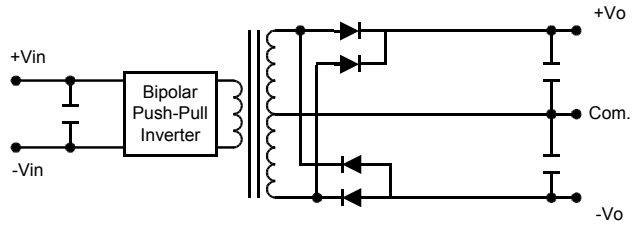

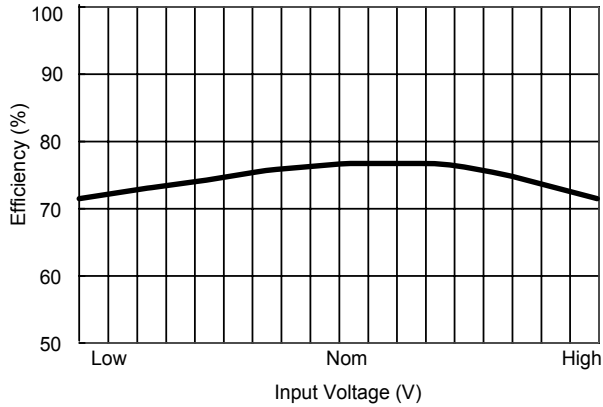

**Efficiency vs Input Voltage ( Single Output )**

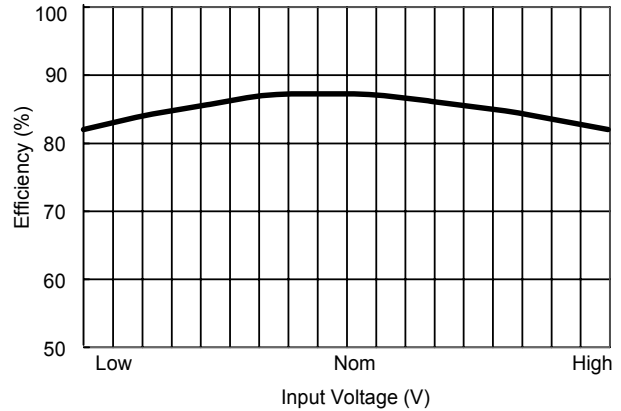

**Efficiency vs Input Voltage ( Dual Output )**

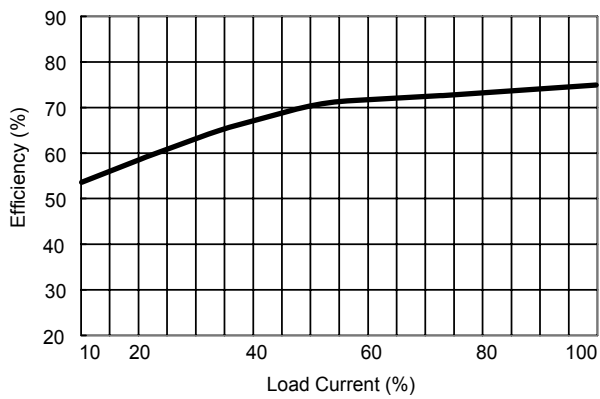

**Efficiency vs Output Load ( Single Output )**

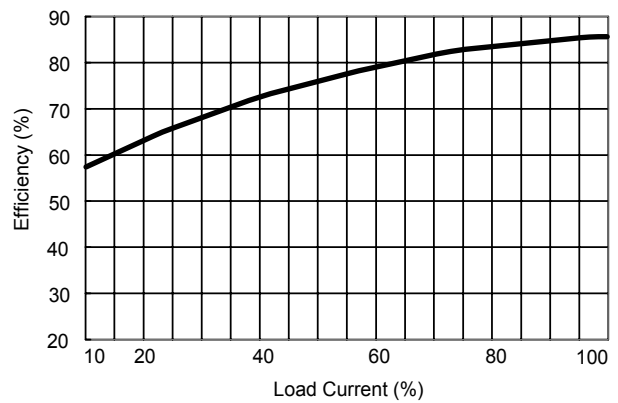

**Efficiency vs Output Load ( Dual Output )**

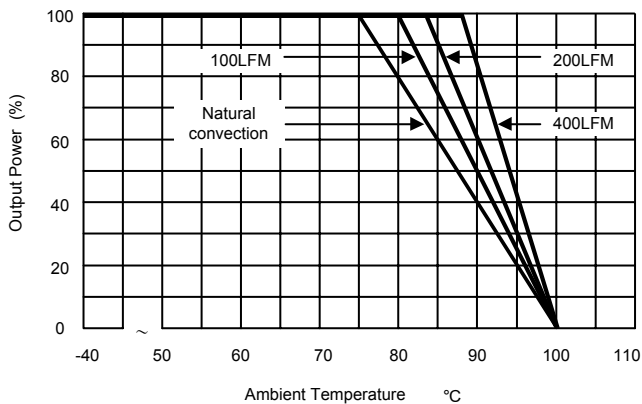

**Derating Curve ( 3.3V, 5V & ±5V )**

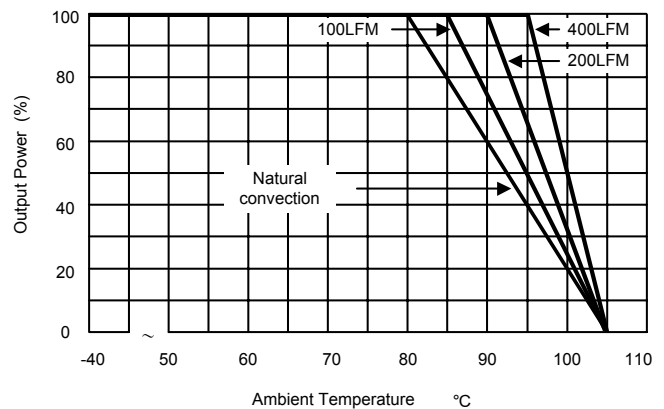

**Derating Curve ( all other output )**

## Test Configurations

### Input Reflected-Ripple Current Test Setup

Input reflected-ripple current is measured with an inductor  $L_{in}$  (4.7 $\mu$ H) and  $C_{in}$  (220 $\mu$ F, ESR < 1.0 $\Omega$  at 100 KHz) to simulate source impedance.

Capacitor  $C_{in}$ , offsets possible battery impedance.

Current ripple is measured at the input terminals of the module, measurement bandwidth is 0–500 KHz.

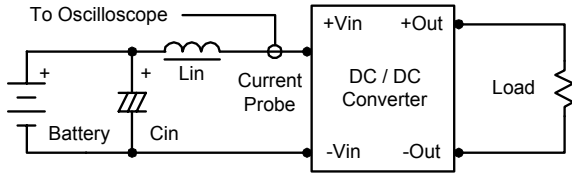

### Peak-to-Peak Output Noise Measurement Test

Use a  $C_{out}$  0.33 $\mu$ F ceramic capacitor.

Scope measurement should be made by using a BNC socket, measurement bandwidth is 0–20 MHz. Position the load between 50 mm and 75 mm from the DC/DC Converter.

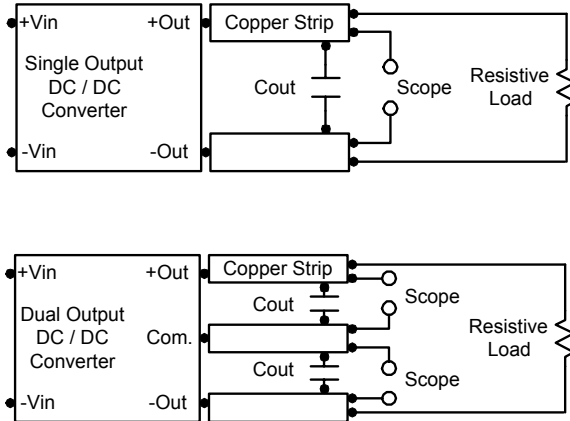

## Design & Feature Considerations

### Maximum Capacitive Load

The MAU100 series has limitation of maximum connected capacitance at the output.

The power module may be operated in current limiting mode during start-up, affecting the ramp-up and the startup time.

For optimum performance we recommend 100 $\mu$ F maximum capacitive load for dual outputs and 220 $\mu$ F capacitive load for single outputs.

The maximum capacitance can be found in the data sheet.

### Input Source Impedance

The power module should be connected to a low ac-impedance input source. Highly inductive source impedances can affect the stability of the power module.

In applications where power is supplied over long lines and output loading is high, it may be necessary to use a capacitor at the input to ensure startup.

Capacitor mounted close to the power module helps ensure stability of the unit, it is commended to use a good quality low Equivalent Series Resistance (ESR < 1.0 $\Omega$  at 100 KHz) capacitor of a 2.2 $\mu$ F for the 5V input devices, a 1.0 $\mu$ F for the 12V,15V input devices and a 0.47 $\mu$ F for the 24V devices.

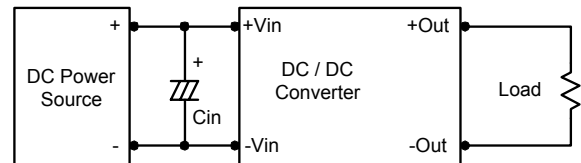

### Output Ripple Reduction

A good quality low ESR capacitor placed as close as practicable across the load will give the best ripple and noise performance.

To reduce output ripple, it is recommended to use 1.0 $\mu$ F capacitors at the output.

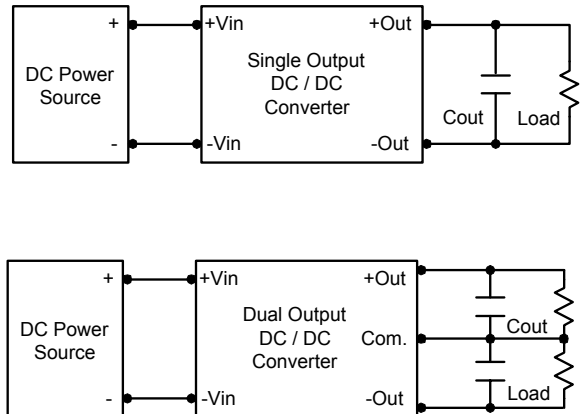

## Thermal Considerations

Many conditions affect the thermal performance of the power module, such as orientation, airflow over the module and board spacing. To avoid exceeding the maximum temperature rating of the components inside the power module, the case temperature must be kept below 90°C.

The derating curves are determined from measurements obtained in an experimental apparatus.

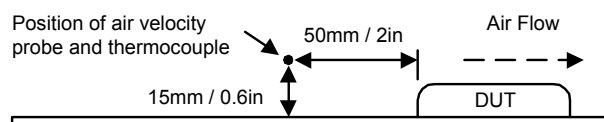

## Mechanical Dimensions

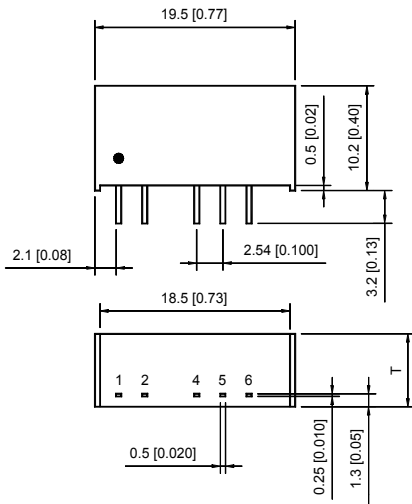

Tolerance	Millimeters	Inches
	$X.X \pm 0.25$	$X.XX \pm 0.01$
	$X.XX \pm 0.13$	$X.XXX \pm 0.005$
Pin	$\pm 0.05$	$\pm 0.002$

## Physical Characteristics

**Case Size (5 & 12V Input)** : 19.5×6.1×10.2 mm  
0.77×0.24×0.40 inches

**Case Size (15 & 24V Input)** : 19.5×7.1×10.2 mm  
0.77×0.28×0.40 inches

**Case Material** : Non-Conductive Black Plastic

**Weight** : 2.2g (5 & 12V Input)  
2.6g (15 & 24V Input)

## Pin Connections

Pin	Single Output	Dual Output
1	+Vin	+Vin
2	-Vin	-Vin
4	-Vout	-Vout
5	No Pin	Common
6	+Vout	+Vout