

FFAF10U40DN

Features

- Ultrafast with soft recovery
- Low forward voltage

Applications

- Power switching circuits
- Output rectifiers
- Freewheeling diodes
- Switching mode power supply

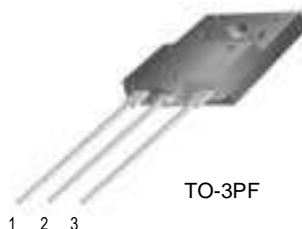

TO-3PF

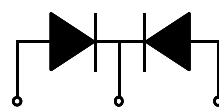

1. Anode 2. Cathode 3. Anode

ULTRA FAST RECOVERY POWER RECTIFIER

Absolute Maximum Ratings (per diode) $T_C=25^\circ\text{C}$ unless otherwise noted

Symbol	Parameter	Value	Units
V_{RRM}	Peak Repetitive Reverse Voltage	400	V
$I_{F(AV)}$	Average Rectified Forward Current @ $T_C = 100^\circ\text{C}$	10	A
I_{FSM}	Non-repetitive Peak Surge Current 60Hz Single Half-Sine Wave	100	A
T_J, T_{STG}	Operating Junction and Storage Temperature	- 65 to +150	$^\circ\text{C}$

Thermal Characteristics

Symbol	Parameter	Value	Units
$R_{\theta JC}$	Maximum Thermal Resistance, Junction to Case	4.0	$^\circ\text{C}/\text{W}$

Electrical Characteristics (per diode) $T_C=25^\circ\text{C}$ unless otherwise noted

Symbol	Parameter	Min.	Typ.	Max.	Units	
V_{FM}^*	Maximum Instantaneous Forward Voltage $I_F = 10\text{A}$ $I_F = 10\text{A}$	$T_C = 25^\circ\text{C}$	-	-	1.4	V
		$T_C = 100^\circ\text{C}$	-	-	1.3	
I_{RM}^*	Maximum Instantaneous Reverse Current @ rated V_R	$T_C = 25^\circ\text{C}$	-	-	30	μA
		$T_C = 100^\circ\text{C}$	-	-	300	
t_{rr}	Maximum Reverse Recovery Time	-	-	50	ns	
I_{rr}	Maximum Reverse Recovery Current	-	-	4.5	A	
Q_{rr}	Maximum Reverse Recovery Charge ($I_F = 10\text{A}$, $di/dt = 200\text{A}/\mu\text{s}$)	-	-	113	nC	
W_{AVL}	Avalanche Energy	1.0	-	-	mJ	

* Pulse Test: Pulse Width=300 μs , Duty Cycle=2%

Typical Characteristics

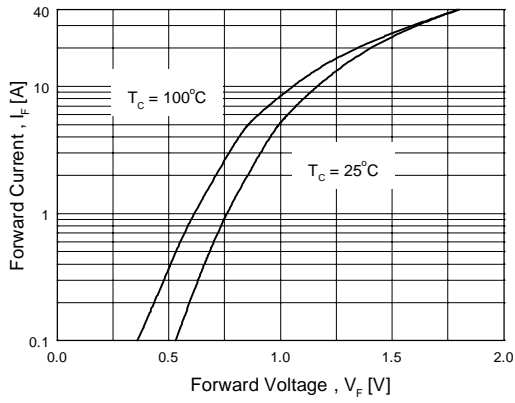

Figure 1. Typical Forward Voltage Drop vs. Forward Current

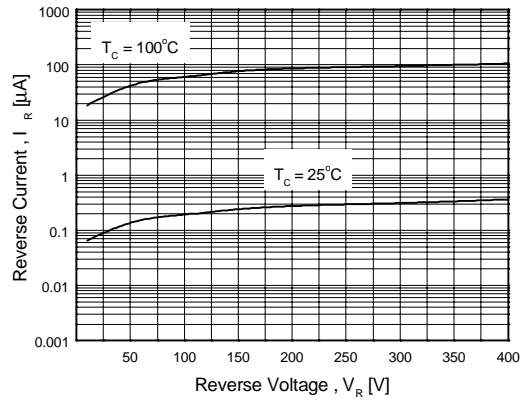

Figure 2. Typical Reverse Current vs. Reverse Voltage

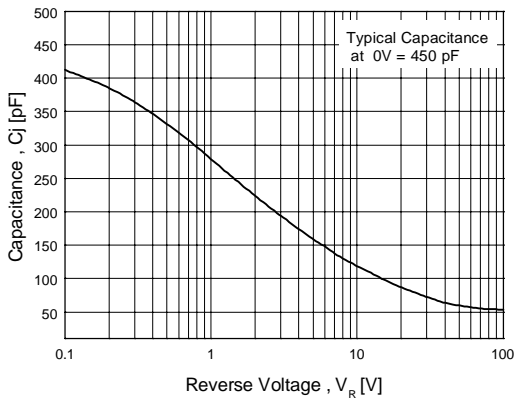

Figure 3. Typical Junction Capacitance

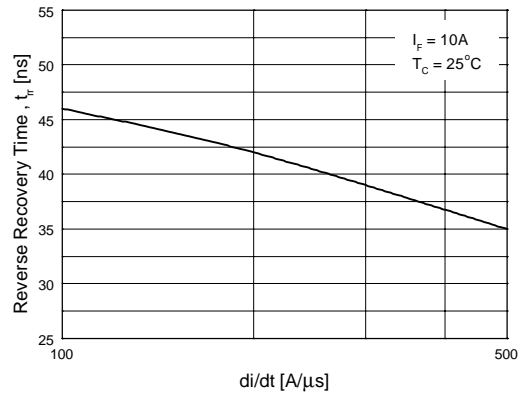

Figure 4. Typical Reverse Recovery Time vs. di/dt

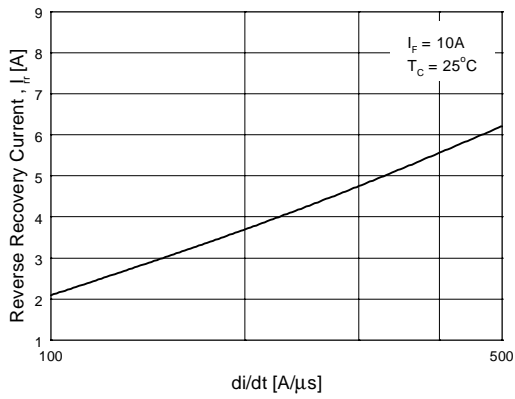

Figure 5. Typical Reverse Recovery Current vs. di/dt

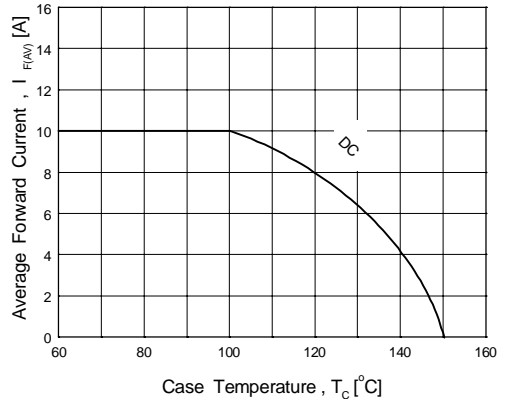
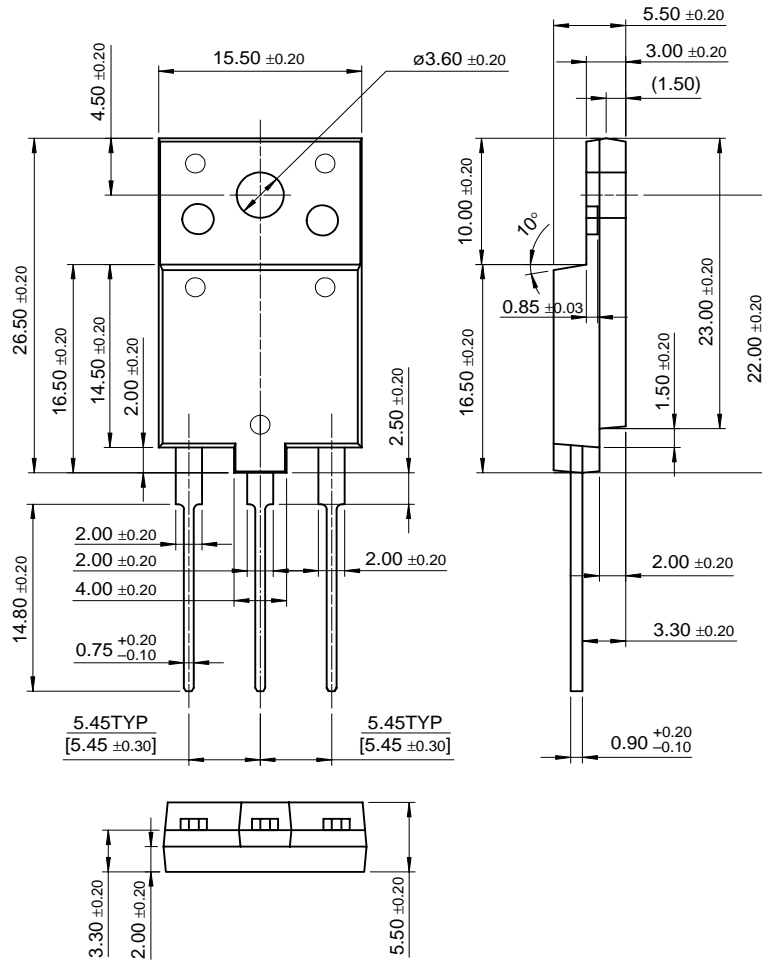

Figure 6. Forward Current Derating Curve

Package Dimensions

TO-3PF

FFAF10U40DN



Dimensions in Millimeters

TRADEMARKS

The following are registered and unregistered trademarks Fairchild Semiconductor owns or is authorized to use and is not intended to be an exhaustive list of all such trademarks.

ACE ^x TM	FAST ^r TM	QFET TM	VCX TM
Bottomless TM	GlobalOptoisolator TM	QS TM	
CoolFET TM	GTO TM	QT Optoelectronics TM	
CROSSVOLT TM	HiSeC TM	Quiet Series TM	
DO ^{ME} TM	ISOP ^{LANAR} TM	SuperSOT TM -3	
E ² CMOS TM	MICROWIRE TM	SuperSOT TM -6	
EnSigna TM	OPTOLOGIC TM	SuperSOT TM -8	
FACT TM	OPTOPLANAR TM	SyncFET TM	
FACT Quiet Series TM	POP TM	TinyLogic TM	
FAST [®]	PowerTrench [®]	UHC TM	

DISCLAIMER

FAIRCHILD SEMICONDUCTOR RESERVES THE RIGHT TO MAKE CHANGES WITHOUT FURTHER NOTICE TO ANY PRODUCTS HEREIN TO IMPROVE RELIABILITY, FUNCTION OR DESIGN. FAIRCHILD DOES NOT ASSUME ANY LIABILITY ARISING OUT OF THE APPLICATION OR USE OF ANY PRODUCT OR CIRCUIT DESCRIBED HEREIN; NEITHER DOES IT CONVEY ANY LICENSE UNDER ITS PATENT RIGHTS, NOR THE RIGHTS OF OTHERS.

LIFE SUPPORT POLICY

FAIRCHILD'S PRODUCTS ARE NOT AUTHORIZED FOR USE AS CRITICAL COMPONENTS IN LIFE SUPPORT DEVICES OR SYSTEMS WITHOUT THE EXPRESS WRITTEN APPROVAL OF FAIRCHILD SEMICONDUCTOR CORPORATION. As used herein:

1. Life support devices or systems are devices or systems which, (a) are intended for surgical implant into the body, or (b) support or sustain life, or (c) whose failure to perform when properly used in accordance with instructions for use provided in the labeling, can be reasonably expected to result in significant injury to the user.
2. A critical component is any component of a life support device or system whose failure to perform can be reasonably expected to cause the failure of the life support device or system, or to affect its safety or effectiveness.

PRODUCT STATUS DEFINITIONS

Definition of Terms

Datasheet Identification	Product Status	Definition
Advance Information	Formative or In Design	This datasheet contains the design specifications for product development. Specifications may change in any manner without notice.
Preliminary	First Production	This datasheet contains preliminary data, and supplementary data will be published at a later date. Fairchild Semiconductor reserves the right to make changes at any time without notice in order to improve design.
No Identification Needed	Full Production	This datasheet contains final specifications. Fairchild Semiconductor reserves the right to make changes at any time without notice in order to improve design.
Obsolete	Not In Production	This datasheet contains specifications on a product that has been discontinued by Fairchild semiconductor. The datasheet is printed for reference information only.

Rev. F1