

Schottky Barrier Diodes

30V

V _{RM} (V)	Package	Part Number	I _F (AV) (A)	I _{FSM} (A)	T _J (°C)	T _{stg} (°C)	V _F (V) max	I _F (A)	I _R (mA)	I _R (H) (mA)	R _{th} (j-ℓ) (°C/W)	R _{th} (j-c) (°C/W)	Mass (g)	Fig. No.	Page where characteristic curve is shown
				50Hz Half-cycle Sinewave Single Shot					V _R =V _{RM} max	V _R =V _{RM} max					
30	Surface Mount	MI1A3	1.0	12	-40 to +150	0.47	1.0	1	70	150 (T _J)	70	0.011	1	79	
		MI2A3	1.0	12	-40 to +125	0.39	1.0	2	110	125 (T _J)	70	0.011			
		SFPA-53	1.0	30	-40 to +125	0.36	1.0	1.5	70	100	20	0.072			
		SFPJ-53	1.0	30	-40 to +150	0.45	1.0	1.0	35	150	20	0.072	2		
		SFPA-63	2.0	40	-40 to +125	0.36	2.0	3.0	140	100	20	0.072			
		SFPE-63	2.0	40	-40 to +150	0.55	2.0	0.2	20	150 (T _J)	20	0.072			
		SFPJ-63	2.0	40	-40 to +150	0.45	2.0	2.0	70	150	20	0.072			
		SFPA-73	3.0	50	-40 to +125	0.36	3.0	4.5	210	100	20	0.072	3		
		SFPJ-73	3.0	50	-40 to +150	0.45	3.0	3.0	100	150	20	0.072			
	SPJ-G53S	5.0	100	-40 to +150	0.45	5.0	5.0	250	150	5	0.29				
	SPJ-63S	6.0	50	-40 to +150	0.45	3.0	3	100	150 (T _J)	5	0.29	4			
	Axial	AK 03	1.0	25	-40 to +150	0.55	1.0	1	50	100 (T _J)	22		0.13	82	
		EA 03	1.0	30	-40 to +125	0.36	1.0	1.5	70	100	20		0.3	—	
		EK 03	1.0	40	-40 to +150	0.55	1.0	5	50	100	20		0.3	5	
		EK 13	1.5	40	-40 to +150	0.55	2.0	5	50	100	17		0.3		83
		RK 13	1.7	60	-40 to +150	0.55	2.0	5	50	100	15		0.45	6	
		RA 13	2.0	40	-40 to +125	0.36	2.0	3	140	100	15		0.45		—
		RK 33	2.5	50	-40 to +150	0.55	2.5	5	50	100	12		0.6	7	
		RJ 43	3.0	50	-40 to +150	0.45	3.0	3	100	150	8		1.2		—
RK 43		3.0	80	-40 to +150	0.55	3.0	5	50	100	8	1.2		8		
FMJ-23L		10	100	-40 to +150	0.45	5.0	5	250	150 (T _J)	4	2.1	90			
FMJ-2203	20	150	-40 to +150	0.47	10.0	10	350	150	4	2.1	9				
FMJ-2303	30	150	-40 to +150	0.48	15.0	15	500	150	4	2.1		—			

External Dimensions

Flammability: UL94V-0 or Equivalent (Unit: mm)

1

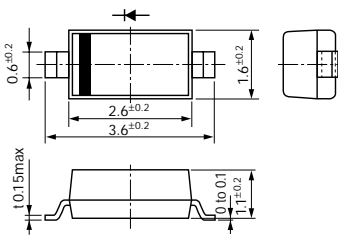

2

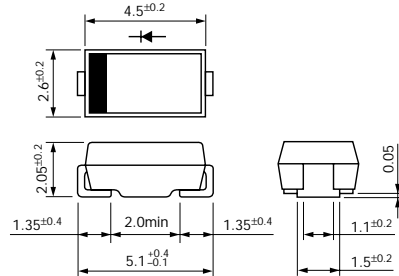

3

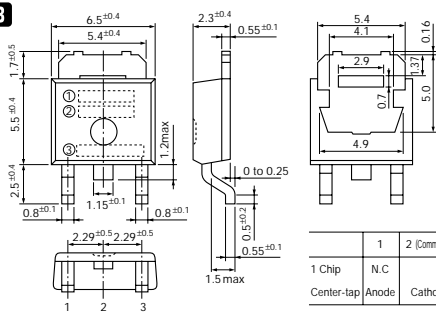

4

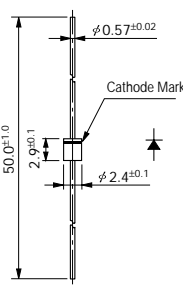

5

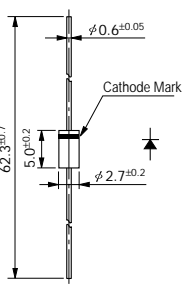

6

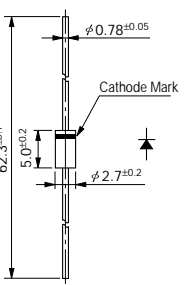

7

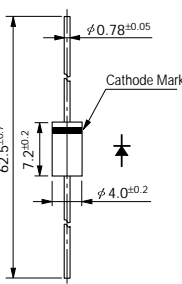

8

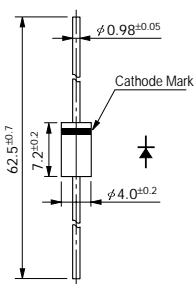

9

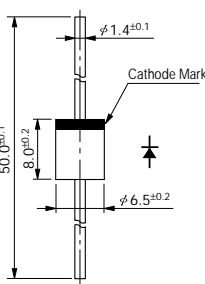

10

