

Features

- Glass Passivated Die Construction
- Diffused Junction
- Ultra-Fast Switching for High Efficiency
- High Current Capability and Low Forward Voltage Drop
- Surge Overload Rating to 30A Peak
- Low Reverse Leakage Current
- **Lead Free Finish, RoHS Compliant (Note 4)**

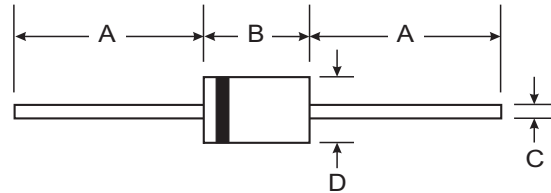

Mechanical Data

- Case: DO-41
- Case Material: Molded Plastic. UL Flammability Classification Rating 94V-0
- Moisture Sensitivity: Level 1 per J-STD-020C
- Terminals: Finish - Bright Tin. Plated Leads Solderable per MIL-STD-202, Method 208
- Polarity: Cathode Band
- Marking: Type Number
- Ordering Information: See Last Page
- Mounting Position: Any
- Weight: 0.35 grams (approximate)

DO-41		
Dim	Min	Max
A	25.40	—
B	4.06	5.21
C	0.71	0.864
D	2.00	2.72
All Dimensions in mm		

Maximum Ratings and Electrical Characteristics @ T_A = 25°C unless otherwise specified

Single phase, half wave, 60Hz, resistive or inductive load.
For capacitive load, derate current by 20%.

Characteristic	Symbol	UG1001	UG1002	UG1003	UG1004	UG1005	Unit
Peak Repetitive Reverse Voltage	V _{RRM}	50	100	200	400	600	V
Working Peak Reverse Voltage	V _{RWM}						
DC Blocking Voltage	V _R						
RMS Reverse Voltage	V _{R(RMS)}	35	70	140	280	420	V
Average Rectified Output Current (Note 1)	I _O	1.0					A
		@ T _A = 55°C					
Non-Repetitive Peak Forward Surge Current 8.3ms Single half sine-wave superimposed on Rated Load (JEDEC Method)	I _{FSM}	30					A
Forward Voltage	V _{FM}	1.0			1.3	1.7	V
		@ I _F = 1.0A					
Peak Reverse Current	I _{RM}	5.0					μA
		@ T _A = 25°C					
		@ T _A = 100°C					100
Reverse Recovery Time (Note 3)	t _{rr}	50				75	ns
Typical Junction Capacitance (Note 2)	C _j	20				10	pF
Typical Thermal Resistance Junction to Ambient	R _{θJA}	95					K/W
Operating and Storage Temperature Range	T _j , T _{STG}	-65 to +150					°C

- Notes:
1. Valid provided that leads are maintained at ambient temperature at a distance of 9.5mm from the case.
 2. Measured at 1.0MHz and applied reverse voltage of 4.0V DC.
 3. Measured with I_F = 0.5A, I_R = 1.0A, I_{rr} = 0.25A. See figure 5.
 4. RoHS revision 13.2.2003. Glass and High Temperature Solder Exemptions Applied, see EU Directive Annex Notes 5 and 7.

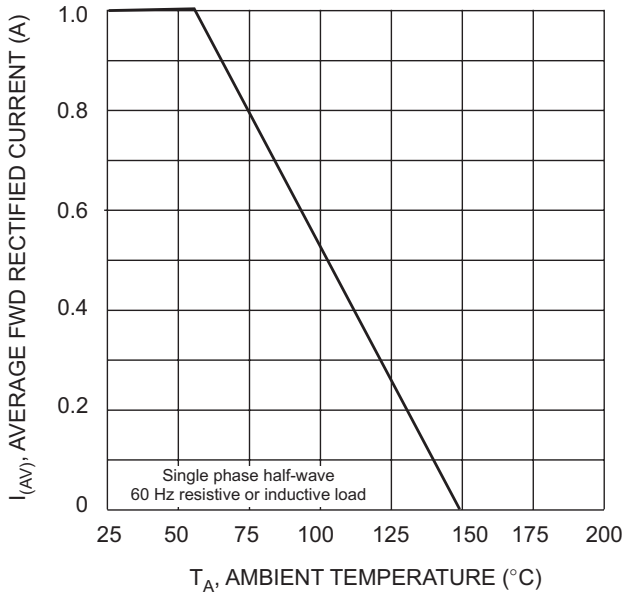

Fig. 1 Forward Current Derating Curve

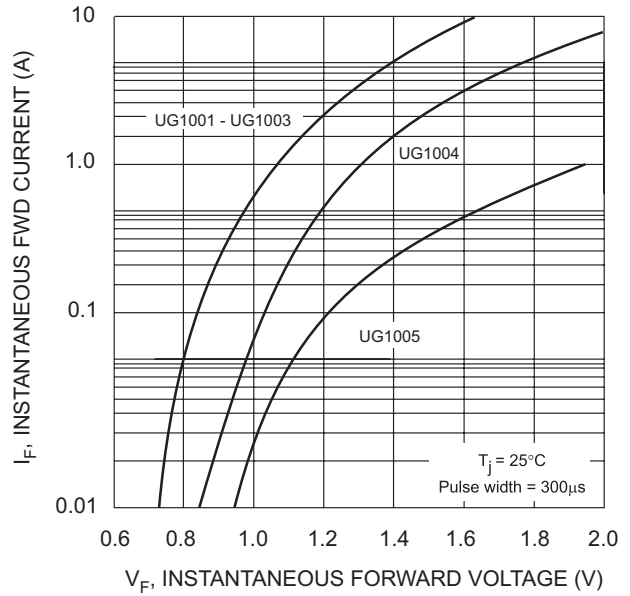

Fig. 2 Typical Forward Characteristics

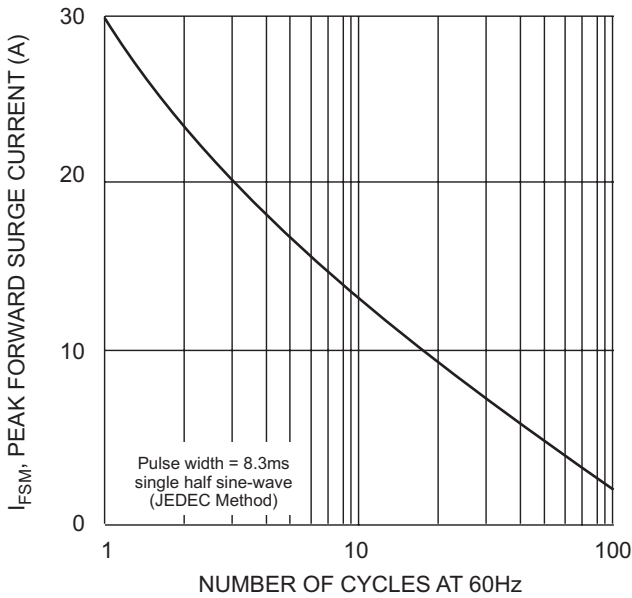

Fig. 3 Peak Forward Surge Current

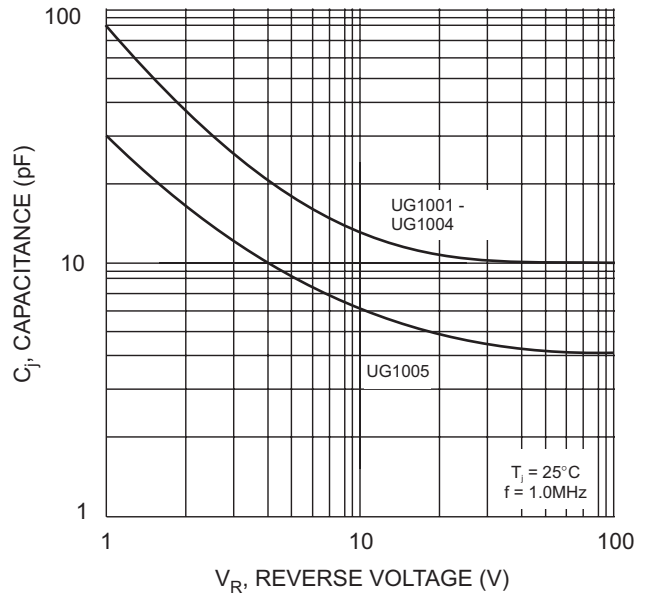
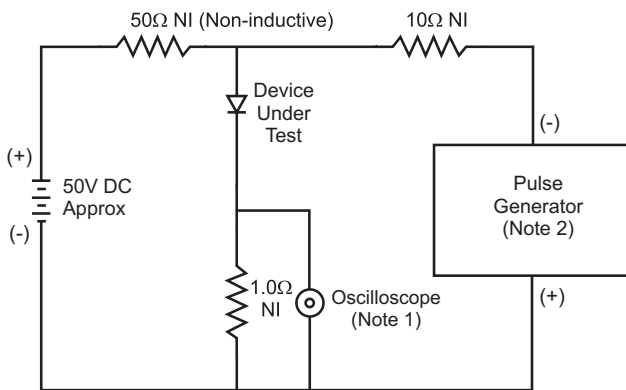
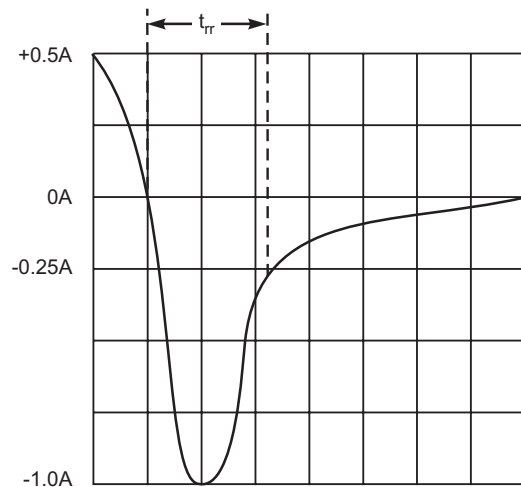

Fig. 4 Typical Junction Capacitance



- Notes:
1. Rise Time = 7.0ns max. Input Impedance = 1.0MΩ, 22pF.
 2. Rise Time = 10ns max. Input Impedance = 50Ω.



Set time base for 50/100 ns/cm

Fig. 5 Reverse Recovery Time Characteristic and Test Circuit

Ordering Information (Note 5)

Device	Packaging	Shipping
UG1001-A	DO-41	5K/Ammo Pack
UG1001-B	DO-41	1K/Bulk
UG1001-T	DO-41	5K/Tape & Reel, 13-inch
UG1002-A	DO-41	5K/Ammo Pack
UG1002-B	DO-41	1K/Bulk
UG1002-T	DO-41	5K/Tape & Reel, 13-inch
UG1003-A	DO-41	5K/Ammo Pack
UG1003-B	DO-41	1K/Bulk
UG1003-T	DO-41	5K/Tape & Reel, 13-inch
UG1004-A	DO-41	5K/Ammo Pack
UG1004-B	DO-41	1K/Bulk
UG1004-T	DO-41	5K/Tape & Reel, 13-inch
UG1005-A	DO-41	5K/Ammo Pack
UG1005-B	DO-41	1K/Bulk
UG1005-T	DO-41	5K/Tape & Reel, 13-inch

Notes: 5. For packaging details, visit our website at <http://www.diodes.com/datasheets/ap02008.pdf>